

MARCO ISLAND NUTRIENT SOURCE EVALUATION PROJECT

Final Report – September 2021



Prepared For:



City of Marco Island Public Works
50 Bald Eagle Drive
Marco Island, FL 34145
239-389-5000

Prepared By:



Environmental Research & Design, Inc.
3419 Trentwood Blvd., Suite 102
Belle Isle (Orlando), FL 32812-4864
407-855-9465

EXECUTIVE SUMMARY

Introduction

The City of Marco Island is a 15.6 mi² area located in southern Collier County about 20 miles south of Naples and is the largest Barrier Island within southwest Florida's Ten Thousand Islands. Major development activities on Marco Island were initiated in the early 1960s which included dredging of the extensive canal system. Currently, the City has over 100 miles of internal and external waterways which are used extensively by residents and visitors for a variety of recreational activities.

In recent years, citizens have become concerned about declining water quality, both visually and chemically, in the extensive canal and waterway system which is an integral part of the City and provides direct access to off-shore waters for many residents. Marco Island has been listed by the Florida Department of Environmental Protection (FDEP) as impaired for nutrients (nitrogen) based upon annual geometric mean total nitrogen concentrations exceeding 0.30 mg/l during 2017 and 2018. The FDEP priority for TMDL development for Marco Island is "medium" which means that TMDL development is likely 5-10 years away. Off-shore areas southeast of Marco Island are also listed as impaired for total nitrogen, as well as total phosphorus and fecal coliform, due to exceedances of the applicable criteria for these parameters in recent years.

Current Study

During October 2019, the City issued a Request for Proposal (RFP #19-033: Consulting Services for Nutrient Source Evaluation and Assessment) which solicited proposals from qualified consultants to evaluate nutrient sources and provide recommendations for water quality improvement. ERD was selected by the City, and a Scope of Work and project schedule were developed and approved by the City Commission. Work efforts were initiated on this project by ERD during April 2020.

A field monitoring program was conducted by ERD from April-November 2020 to identify ambient water quality characteristics and collect hydrologic and water quality data for use in developing hydrologic and nutrient budgets for the waterways. A detailed evaluation of sediment characteristics in Marco Island waterways was also conducted which included physical and chemical characterization of surficial sediments and evaluation of internal nutrient recycling. This study collected 600 individual samples of rainfall, runoff, groundwater seepage, and sediment nutrient release, with more than 5,300 individual lab analyses and more than 4,200 field measurements to identify nutrient sources.

Historical Water Quality Characteristics

Marco Island Waterways

Limited water quality monitoring has been conducted within the Marco Island waterways since approximately 2001. At that time, the City chose 12 monitoring locations which were spatially distributed over the island to include primary waterways and drainage basin areas with monitoring frequencies ranging from monthly, to bi-monthly, to quarterly. A more intensive bi-monthly water quality monitoring program was initiated in 2007, and in 2015, two additional sites were added and sampling was changed to a monthly collection interval at all 12 sites. These efforts have generated a large amount of good quality data.

Overall, water quality characteristics in Marco Island waterways have been relatively consistent at most sites from 2015-2020, although statistically significant increases in values over time have been observed for total nitrogen, chlorophyll-a, and Secchi disk depth at the Barfield Bridge site; for total nitrogen and total phosphorus at the Collier Bridge site; and for total nitrogen at the McIlvaine site. Overall, mean total nitrogen concentrations in Marco Island waterways from 2015-2020 have been moderate to elevated in value, with virtually all measurements exceeding the water quality criterion of 300 µg/l.

Annual mean total phosphorus concentrations in Marco Island waterways have been low to moderate in value, with concentrations at 11 of the 14 monitoring sites less than or equal to the applicable criterion of 46 µg/l for total phosphorus. Exceedances of the criterion for both total nitrogen and total phosphorus have been consistently observed at the Landmark and Swallow monitoring sites, each of which is located in upstream portions of a relatively stagnant canal system.

Enterococci counts at a majority of the Marco Island monitoring sites are well below the FDEP criterion for this parameter of 35 cfu/100 ml. However, substantial exceedances of the Enterococci standard have been observed at the Olde Marco and Swallow monitoring sites, suggesting possible sewage impacts at these sites. The Olde Marco district has a privately owned and operated collection system. Sewage from Old Marco Lane North is collected by North Marco Utilities and pumped to the City wastewater facility for treatment.

Off-Site Waters

In addition to the historical monitoring conducted by the City of Marco Island (discussed in the previous section), a large amount of historical monitoring data has been collected by other agencies, such as Collier County, the South Florida Water Management District (SFWMD), FDEP, and the Florida Department of Health (FDOH) in off-island waters although multiple monitoring sites have also been included within the Marco Island waterways.

From 2015-2020, off-shore sites surrounding Marco Island exhibited annual geometric mean (AGM) values for total nitrogen which exceeded the NNC of 300 µg/l during 28 of the 30 annual periods of data available at SFWMD and FDEP monitoring sites. Exceedances of the NNC for total phosphorus were observed during 9 of the 27 annual periods (33%), with exceedances of the NNC for chlorophyll-a during 3 of the 27 annual periods. Exceedances in Enterococci counts have also been observed on the northwest shoreline of the island, particularly in recent years.

Off-shore areas provide the baseline water quality for Marco Island waterways and reflect water quality characteristics which would be present if no additional inputs occurred from Marco Island. Marco Island can, and does, add to existing concentrations but cannot reduce nutrient levels below the existing elevated levels. NNC criteria cannot be met in Marco Island waterways until the baseline water quality meets NNC.

Current Water Quality Characteristics

A monthly surface water quality monitoring program was conducted in Marco Island waterways and off-shore waters by ERD from April-September 2020 at 17 fixed monitoring locations. The surface water monitoring sites were selected to provide general information on ambient water quality characteristics, evaluate horizontal and vertical water quality variability, and assist in identifying potential significant loading sources. Six separate monitoring events were conducted at each of the 17 sites.

Water quality monitoring conducted by ERD indicated a well mixed water column at all on- and off-shore monitoring sites within the top 4-5 m of the water column. However, areas deeper than 4-5 m, particularly in upstream portions of the canals, were characterized by anaerobic conditions with large increases in conductivity near the water-sediment interface. These conditions suggest poor circulation and relatively stagnant conditions in upstream areas. Chemical characteristics of surface water samples collected by ERD are similar to long-term historical values measured in Marco Island waterways. Waterway samples suggest an enrichment in concentrations for nutrients and chlorophyll-a, compared with off-shore waters, which increases with increasing distance upstream within the waterways. No significant differences were observed in water quality characteristics between incoming and outgoing tidal events, although concentrations of nutrients and chlorophyll-a were often higher under outgoing tidal conditions.

Watershed Characteristics

A delineation of contributing drainage basin areas for Marco Island was conducted by ERD as part of this project. The main island is divided into 5 sections, referred to as Sub-basins 1-5, which are bisected in an east-west direction by San Marco Road and in a north-south direction by Bald Eagle Drive and S. Heathwood Drive, although the north-south separation is not as definitive as the east-west separation. The northeast section is further sub-divided into areas which discharge to Factory Bay and areas which discharge to Marco Bay. Each of the 5 sub-basins discharges through the respective canal systems to open tidal water. Sub-basin 1 discharges to Collier Bay and Marco Bay. Sub-basin 2 discharges to Factory Bay and ultimately to Marco Bay, with Sub-basin 3 discharging to East Marco Bay, Sub-basin 4 discharging to Caxambas Bay, and Sub-basin 5 discharging to Roberts Bay and ultimately to Caxambas Bay.

Under current conditions, the Marco Island drainage basin is dominated primarily by medium-density residential, multi-family residential, commercial, recreational, and highway land uses. In addition to the developed land use categories listed previously, the drainage basin also includes open spaces, forests, wetlands, and fresh and saltwater ponds. Soils within the drainage basin are well-drained with a rapid infiltration rate.

Stormwater

Marco Island has constructed an extensive stormsewer system to collect and discharge runoff generated during rain events. Most stormsewer systems are relatively short in length and discharge surface runoff into the nearest canal system or open water. Overall, the Marco Island stormsewer system has 1,864 stormsewer inlets with 1,324 of the current inlets (71%) retrofitted with inlet filters manufactured by Suntree which are designed to remove leaves, litter, and solid debris. The inlets are periodically cleaned and serviced by City personnel.

Currently, Marco Island has 393 stormsewer outfalls, with the vast majority discharging to the canal system. Only one of the outfalls discharges directly to the Gulf of Mexico, with 7 outfalls discharging to Barfield Bay, 10 outfalls discharging to Roberts Bay, 2 outfalls discharging to Caxambas Bay, and 5 outfalls discharging to Collier Bay. Most areas use a system of grassed swales to convey surface runoff, and a large portion of the generated runoff volume infiltrates into groundwater. Most of the larger developments have stormwater treatment systems consisting of dry ponds, but treatment systems are not present in residential areas.

Sewage Disposal

Currently, disposal of sanitary sewage on Marco Island occurs almost exclusively using a central sewer collection system. According to the Water and Sewer Department (W&SD), only approximately 20-21 on-site treatment systems remain on the island, and the remaining systems will be phased out by 2024.

Collected raw sewage is transported through an extensive network of underground sewer mains to a sewage treatment facility located south of Factory Bay near the intersection of E. Elkcam and Windward Drive, referred to as the Marco Island Reclaimed Water Production Facility (RWPF). The facility provides treatment for wastewater generated on Marco Island along with portions of the Isles of Capri and Goodland. The average daily sewage inflow to the plant from 2011-2020 has been 2.20 MGD compared with a capacity of 4.92 MGD.

Reuse Irrigation

Virtually all sewage treated at the Marco Island wastewater treatment plant becomes reuse irrigation and, according to the W&SD, the demand often exceeds the availability. During these conditions, raw water from the City's primary drinking water source is used to augment the reuse system either directly or indirectly. Reuse irrigation is applied to 229.99 acres of area golf courses at a rate of 0.56 inch/week and to 398.96 acres of public access areas, both on and off island, at a rate of 0.88 inch/week. Reuse irrigation contains concentrations of total nitrogen which are an order of magnitude higher in concentration than adjacent waterways and concentrations of total phosphorus which are 2 orders of magnitude higher.

Hydrologic Inputs

Average annual hydrologic budgets were developed for the waterways associated with Sub-basins 1-5 which include inputs from direct precipitation, stormwater runoff, irrigation, and groundwater seepage. Hydrologic losses are calculated for evaporation and outflow to adjacent tidal waterbodies.

The largest annual hydrologic input to the 5 waterways is groundwater seepage which contributes 60-72% of the total annual hydrologic inputs. Direct precipitation is the second most significant hydrologic input in Sub-basins 1, 2, 4, and 5, with irrigation (consisting of both reuse and potable sources) comprising the second most significant inflow in Sub-basin 3. Inputs of stormwater runoff are minimal in terms of the annual hydrologic budgets, contributing only 4-7% of the annual volumetric inflows. Hydraulic residence times in the waterways are relatively long, ranging from 5-11 months.

Nutrient Inputs

Marco Island waterways receive nutrient inputs from a variety of sources which include bulk precipitation, stormwater runoff, irrigation, shallow groundwater seepage, and internal recycling. Chemical characteristics of bulk precipitation, stormwater runoff, reuse irrigation, and groundwater seepage, along with inputs from internal recycling, were measured by ERD during the period from April-November 2020, and information from each of these sources is used to generate annual average nutrient budgets for total nitrogen and total phosphorus for the waterbodies in the 5 sub-basin areas.

Measured concentrations of nutrients in bulk precipitation were low in value and similar to samples collected in other coastal areas in South Florida. Five automated stormwater monitoring sites were installed in multiple different land uses and in areas with and without reuse irrigation, and a total of 60 stormwater and baseflow samples were collected. Concentrations of total nitrogen were highest in areas with extensive reuse irrigation and residential areas with a high level of landscape maintenance. Reuse samples were characterized by elevated concentrations of both total nitrogen and total phosphorus. Groundwater seepage contained moderate to high concentrations of total nitrogen and total phosphorus, with a large volumetric influx. Sediment release experiments indicated large release of nutrients from waterway sediments under both aerobic and anaerobic conditions.

Nitrogen Loadings

The most significant annual mass loadings of total nitrogen to Marco Island waterbodies originates from sediment nutrient release which contributes 61-77% of the annual nitrogen loadings, depending upon sub-basin. The second most significant nitrogen loading to Marco Island waterbodies is groundwater seepage which contributes 15-30% of the estimated annual loadings. Combined together, sediment nutrient release and groundwater seepage contribute approximately 90% or more of the annual nitrogen loads for most sub-basins.

Annual mass loadings of total nitrogen from stormwater runoff to Marco Island waterbodies are low in comparison to other sources, contributing only 3-9% of the annual nitrogen inputs. The smallest annual contribution of total nitrogen originates from bulk precipitation which contributes 1.4-3.9% of the annual nitrogen loadings, depending upon the particular sub-basin. Areal nitrogen loadings to the 5 waterbodies range from 9.3-25.8 g N/m²-yr which are somewhat higher than relatively undisturbed estuary systems.

Phosphorus Loading

On an average annual basis, the most significant loadings of total phosphorus to Marco Island waterbodies originates from sediment nutrient release which contributes 42-72% of the annual phosphorus loadings, depending upon sub-basin area. Groundwater seepage is the second most significant loading source for phosphorus in Sub-basins 1, 2, 3, and 4, contributing 18-42% of the annual phosphorus loading to adjacent waterbodies. However, for Sub-basin 5 waterways, stormwater runoff is the second most significant loading source, contributing 24% of the annual phosphorus loading to this waterway.

Stormwater runoff is the third most significant phosphorus source to Sub-basins 1, 2, 3, and 4, contributing 7-13% of the annual phosphorus loadings. Groundwater seepage is the third most significant phosphorus loading to Sub-basin 5. Phosphorus loadings to Marco Island waterbodies from bulk precipitation are relatively minimal, contributing only 2-4% of the annual average phosphorus inputs.

Stable Isotope Analyses

Analyses of stable isotopes of Oxygen (O) and Nitrogen (N) were conducted on 235 samples of bulk precipitation, runoff, reuse irrigation, golf course pond, and groundwater seepage. The isotopic data make a strong case for landscaping and reuse irrigation activities as the dominant sources of nitrogen in groundwater seepage inflows to Marco Island waterways. Nitrogen inputs to runoff and baseflow appear to be impacted by a variety of sources, including rainfall, fertilizer, and reuse activities, although the isotope data suggest that landscaping activities may be a more significant source to runoff than reuse irrigation, while reuse appears to impact baseflow characteristics.

Water Quality Management Philosophy

Marco Island is surrounded by multiple bays and channels which receive inflows from large wetland areas located west of US 41, and these inflows are often colored and contain elevated nutrient concentrations. When these inflows combine with tidal waters, the resulting water quality characteristics represent baseline water quality in off-shore areas surrounding Marco Island. This water moves into and out of the extensive canal system with each tidal cycle and creates baseline minimum water quality in the island waterways. When the tidal water enters the waterway canals, nutrient concentrations are enhanced by watershed inputs from precipitation, runoff, irrigation water, and groundwater seepage. It would be virtually impossible to improve waterway quality to levels less than present in the off-island inflows, and the baseline conditions cannot be improved without significant regional projects to improve the characteristics of upland inflows to the off-shore waters.

Both Marco Island waterways and off-shore waters are currently listed as Impaired Waters by FDEP, with Marco Island waterways listed as impaired for nitrogen and off-shore water listed as impaired for nitrogen, phosphorus, and fecal coliform bacteria. Since the baseline water entering the waterways is already impaired, Marco Island waterways will continue to be impaired until the impairment is addressed in the off-shore waters. Even if Marco Island eliminated all inputs of water and nutrients to area waterways, the water quality impairment within the waterways would remain since the incoming water is already impaired. Both historical and current monitoring efforts indicate an enrichment in nutrients within the waterways compared with off-shore waters, and the water quality management options discussed in this report are designed to reduce the enrichment processes to prevent further degradation of inflows after entering the canal systems.

Recommended Management Options

Nutrient loadings to Marco Island waterways originate from a variety of sources, including sediment nutrient recycling, groundwater seepage, stormwater runoff, reuse irrigation, and bulk precipitation. A discussion of each of these inputs is provided in this report. A summary of recommended management options is given below with details provided in the main report.

Internal Recycling

The largest annual nutrient loading to the waterways originates from internal recycling. Given the large cost for sediment removal and lack of research on effects of alum and other sediment treatments in marine environments, the only feasible management option is to improve water quality within the waterways to the extent possible by reducing nutrient loadings from other sources and create a well-mixed and aerobic water column in all areas. Sediment nutrient release occurs at a faster rate when lower portions of the water column become anaerobic, and this release can be minimized, but not eliminated, by maintaining aerobic conditions throughout the water column in all areas.

Stormwater Management

Direct stormwater runoff contributes a small portion of the annual loadings to waterways since virtually all runoff is infiltrated into groundwater through the highly permeable soils. Options were discussed for installation of swale blocks to increase runoff retention, and installation of a denitrification bed beneath existing swales which should be implemented during routine maintenance activities. Continuation of the existing system of inlet filter systems is also recommended.

The City currently relies on water management criteria implemented by SFWMD for construction of stormwater management facilities for development. However, SFWMD provides an exemption from stormwater criteria for single-family homes, and most homes on the island have no stormwater treatment. It is recommended that the City consider adding stormwater management requirements for future homes or re-development. Proven LID systems such as rain gardens can be easily incorporated into the landscape and not recognizable as a stormwater treatment system. Some systems also incorporate a filter media to improve removal of nutrients.

Seepage Inflows

Nutrient loadings from groundwater seepage constitute the second largest source of nitrogen to the waterways and reflect the combined inputs from direct rainfall, infiltrated runoff, irrigation water, and excess fertilizer applications. An option is presented for a denitrification wall to intercept the seepage and convert soluble nitrogen to a gaseous form. The denitrification option should be implemented to existing seawalls during replacement or repair projects, and incorporated into seawalls for all new development.

Reuse Irrigation

Reuse irrigation is currently being applied at rates which exceed the ability of turfgrasses to provide uptake of the water and nutrients, and results in a large amount of the reuse leaching past the root zone into groundwater. The volume of currently applied reuse irrigation which exceeds the evapotranspiration requirements of the vegetation is 12% (526 million gallons/yr or 1.44 MGD) of the total annual seepage volume entering waterways and a much larger percentage of the annual mass loading due to the much higher nutrient concentrations compared with other inputs. The average daily reuse application from 2011-2020 is 1.84 MGD, so 78% (1.44 MGD/1.84 MGD) of the applied reuse irrigation passes through the soil and enters groundwater with little change in concentration. The geometric mean total nitrogen reuse nitrogen concentration from 2012-2021 is 8.72 mg/l. Even if a 50% reduction in concentration is achieved during movement through groundwater, the additional nitrogen loading from excess reuse is 8,312 kg/yr which is 40% of the total annual nitrogen loading from groundwater in all sub-basins combined.

Alternative methods of reuse disposal should be evaluated, and reuse should be applied only as needed to meet evapotranspiration requirements. If reuse were applied only as needed, the groundwater nitrogen impacts would be substantially reduced, resulting in a visible improvement in waterway water quality.

The reuse irrigation system should also be inspected routinely to identify areas of overspray or broken irrigation heads. An educational program should be developed to inform residents about nutrient loadings in reuse and potential water quality impacts from excessive use.

Reuse irrigation is also used on the golf course, but the water is stored in a surface pond prior to application. Nutrient reduction occurs within the pond which reduces the nutrient loading to concentrations similar to urban runoff in other parts of Florida which reduces potential groundwater impacts. However, at the irrigation rates indicated by annual reuse summary forms provided to FDEP, the irrigation rates also exceed evapotranspiration requirements, although not to the extent observed by reuse application in other public areas, and irrigation reduction should be considered to match evapotranspiration requirements. Nutrient loadings from reuse irrigation should be considered in fertilizer applications.

Canal Recirculation

Both historical and current data collected by ERD indicate areas of dead-end canals with poor water quality resulting from lack of tidal flushing. These areas are easily identified on aerial photographs. General options are provided for improving recirculation by interconnecting canal sections on the north and south sides of San Marco Rd. Existing culverts, if present, should be located and cleaned, and the results should be monitored. If the culverts do not exist or do not provide sufficient recirculation, then additional culverts should be installed. A hydraulic study is recommended to identify optimum locations for additional interconnections.

Street Sweeping

Street sweeping is a low-cost alternative for reducing pollutants entrained in runoff. A limited street sweeping program is currently conducted by the City by a private contractor, with sweeping conducted only in intersections and along Collier Blvd. The City has approved purchase of a regenerative air sweeper in the 2022 budget, and the City should use this to increase sweeping to all roadways in Marco Island.

Fertilizer Ordinance

The Fertilizer Ordinance adopted in 2016 appears to contain many of the necessary elements to minimize water quality impacts from fertilizer applications, and fines are proposed for violations of the Ordinance. However, there are currently no personnel assigned to monitor infractions. Enhanced enforcement of this Ordinance is recommended, with repeat offenders losing the right to perform services on the island. The City should develop a voluntary educational program with local fertilizer retailers to inform residents of the fertilizer summer ban.

Public Education

Public education is a powerful and often ignored tool to inform residents about the link between watershed activities and water pollution in the waterways. Most people will alter behavior if they understand the consequences of unintended actions. Opportunities, such as pamphlets, billing inserts, billboards, and public meetings, should be used to educate residents.

Stormwater Utility

The City currently has no dedicated funding source for water quality improvement projects other than general revenues. Adoption of a Stormwater Utility is recommended to provide additional funding sources. A Stormwater Utility is often required by FDEP or local governments to qualify for certain funding grants, and the cost of the Utility could easily be recovered several times over through these grants.

Regulatory Impacts of Impairment

Marco Island waterways have been designated as Impaired by FDEP, and implementation of a TMDL will be initiated within the next 5-10 years. However, FDEP has developed an alternative assessment category, designated as 4e, which allows the responsible entity to conduct an independent evaluation of nutrient sources and management options. ERD recommends that the City pursue this designation to maintain control of the restoration process.

Water Quality Monitoring

The current monthly water quality monitoring program in the Marco Island waterways generates a large amount of useful data and should be continued. Water quality data will become even more important in the future as water quality improvement projects are initiated. The City should engage a qualified water quality consultant to review data and provide annual reviews and updates. Recommendations are provided for enhancing the existing program.

Good News

Multiple options are discussed in this section for reducing nutrient loadings to Marco Island waterways. The field evaluations indicated that groundwater seepage is a large source of loading to surface waters, and reuse irrigation and landscaping activities are the primary loading sources to groundwater. Landscaping activities can be modified at low cost through aggressive educational programs. Reuse impacts can be minimized through low to moderate cost options such as off-island customers and alternative disposal methods such as aquifer recharge which already exists. Modification of impacts from reuse and landscaping is capable of providing measurable improvements in water quality at low costs to the City, and ERD recommends that these issues take priority in management activities.

Management Options Summary

A summary of recommended water quality management options for Marco Island is given in Table ES-1. It is recommended that the management options be implemented as funding sources and opportunities become available.

TABLE ES-1

RECOMMENDED MANAGEMENT OPTIONS FOR MARCO ISLAND

| ISSUE | RECOMMENDATION | COST (\$) |
|--------------------------------------|--|------------------------------|
| Internal Sediment Nutrient Recycling | Sediment removal is prohibitively expensive; most feasible option is to reduce the rate of nutrient release by improving water quality by managing other sources to maintain aerobic conditions in waterways | 189,820,000 |
| Stormwater Management | a. Install shallow swale blocks in swales to increase retention of runoff | \$300/swale block |
| | b. Install denitrification beds beneath existing swales during maintenance or regrading projects. | 8,400/100 ft for media |
| | c. Continue current inlet filter system to assist in removing solids and debris from waterways | Included in current program |
| | d. Consider stormwater management requirements for single-family homes such as rain gardens | Low |
| Seepage Management | Install denitrification beds adjacent to seawalls during repair or replacement; add to new seawalls during construction | 27,000 per 100 ft of seawall |
| Reuse Irrigation | a. Evaluate alternative methods for reuse disposal which do not increase loadings to groundwater or surface water | Unknown |
| | b. Conduct routine inspection and repair of the reuse irrigation system to prevent areas of overspray | |
| | c. Provide an educational program to inform residents about nutrients contained in reuse irrigation and potential water quality impacts | |
| Golf Course | a. Evaluate potential reduction in irrigation rates | Unknown/Low |
| | b. Reduce fertilizer applications to account for nutrients in irrigation | |
| Recirculation | a. Locate and clean existing interconnecting culverts, if present | Unknown/High |
| | b. Conduct a hydraulic study to identify optimum areas for interconnecting culverts to increase recirculation | |
| | c. Install additional culverts, as necessary | |
| Street Sweeping | City to purchase regenerative air sweeper in 2022; increase sweeping to all City streets. | Low |
| Fertilizer Ordinance | a. Assist retailers with educational signage regarding summer season ban | Low |
| | b. Increase enforcement and revoke license from repeat offenders | |
| | c. Modify ordinance to require consideration of nutrients in reuse | |
| Public Education | a. Conduct public education program to inform residents of link between personal activities and water pollution | Low |
| | b. Conduct a dedicated educational program regarding responsible fertilizer use. | |
| Stormwater Utility | Adopt a Stormwater Utility to provide a dedicated funding source for water quality improvement projects | Unknown/Low |
| Regulatory Issues | The City should submit documentation for a 4e designation which would allow the City to control the process rather than FDEP | Low |
| Water Quality Monitoring | a. The City should continue the current monthly monitoring program to provide documentation on water quality improvements; improvements are recommended to enhance the existing program | Low |
| | b. Contract with a qualified water quality consultant to conduct annual reviews of data and trends and provide guidance on implementation of water quality improvement projects | |

TABLE OF CONTENTS

| Section | Page |
|--|------------|
| Table of Contents | TOC-1 |
| List of Figures | LF-1 |
| List of Tables | LT-1 |
| List of Abbreviations and Units of Measure | LA-1 |
| | |
| 1. INTRODUCTION | 1-1 |
| 1.1 General Description | 1-1 |
| 1.2 Impaired Waters Designation | 1-3 |
| 1.3 Previous Water Quality Studies | 1-3 |
| 1.4 Work Efforts Performed by ERD | 1-4 |
| | |
| 2. WATER QUALITY CRITERIA AND CHARACTERISTICS | 2-1 |
| 2.1 Regulatory Water Quality Criteria | 2-1 |
| 2.1.1 Water Quality Criteria | 2-1 |
| 2.1.2 Impaired Waters | 2-3 |
| 2.2 Historical Water Quality Characteristics | 2-4 |
| 2.2.1 Marco Island Waterways | 2-4 |
| 2.2.1.1 Data Availability | 2-4 |
| 2.2.1.2 Data Analysis | 2-5 |
| 2.2.1.3 Data Summary | 2-9 |
| 2.2.1.4 Total Nitrogen | 2-9 |
| 2.2.1.5 Total Phosphorus | 2-12 |
| 2.2.1.6 Chlorophyll-a | 2-12 |
| 2.2.1.7 Secchi Disk Depth | 2-15 |
| 2.2.1.8 Enterococci | 2-15 |
| 2.2.1.9 Trend Analyses | 2-15 |
| 2.2.1.10 Statistical Comparison of Sites | 2-19 |
| 2.2.1.11 Summary | 2-21 |
| 2.2.2 Off-Island Waterways | 2-23 |
| 2.2.2.1 Data Availability | 2-23 |
| 2.2.2.2 Data Analysis | 2-28 |
| 2.2.2.3 Impacts from Off-Island Communities | 2-34 |
| 2.2.2.4 Summary | 2-35 |
| 2.3 Current Water Quality Characteristics | 2-35 |
| 2.3.1 Monitoring Activities | 2-35 |
| 2.3.2 Field Profiles | 2-37 |
| 2.3.2.1 Off-Island Monitoring Sites | 2-38 |
| 2.3.2.2 On-Island Waterways Monitoring Sites | 2-38 |

TABLE OF CONTENTS – CONTINUED

| Section | | Page |
|----------------|---|-------------|
| | 2.3.3 Chemical Characteristics | 2-42 |
| | 2.3.3.1 Impacts of Tidal Events | 2-42 |
| | 2.3.3.2 Comparison of Water Quality Characteristics | 2-45 |
| | 2.3.3.3 Summary | 2-49 |
| 2.4 | Sediment Characteristics | 2-49 |
| | 2.4.1 Sampling Techniques | 2-49 |
| | 2.4.2 Sediment Characterization and Speciation Techniques | 2-51 |
| | 2.4.3 Sediment Characteristics | 2-53 |
| | 2.4.3.1 Visual Characteristics | 2-53 |
| | 2.4.3.2 General Sediment Characteristics | 2-53 |
| | 2.4.3.3 Phosphorus Speciation | 2-56 |
| | 2.4.3.4 Comparison of Sediment Characteristics | 2-59 |
| | 2.4.3.5 Summary | 2-60 |
| 3. | CHARACTERISTICS OF THE MARCO ISLAND DRAINAGE BASIN | 3-1 |
| | 3.1 Watershed Characteristics | 3-1 |
| | 3.2 Land Use in the Marco Island Drainage Basin | 3-3 |
| | 3.3 Area Waterways | 3-4 |
| | 3.4 Soil Characteristics | 3-8 |
| | 3.5 Stormsewer System | 3-10 |
| | 3.6 Topography | 3-10 |
| | 3.7 Sewage Disposal | 3-13 |
| | 3.8 Reuse Irrigation | 3-17 |
| | 3.9 Stormwater Treatment | 3-25 |
| | 3.10 Hydrologic Characteristics | 3-25 |
| | 3.10.1 Impervious Areas | 3-27 |
| | 3.10.2 Directly Connected Impervious Percentages | 3-27 |
| | 3.10.3 Curve Numbers | 3-27 |
| | 3.10.4 Summary | 3-29 |
| 4. | HYDROLOGIC INPUTS AND LOSSES | 4-1 |
| | 4.1 Hydrologic Inputs | 4-2 |
| | 4.1.1 Direct Precipitation | 4-2 |
| | 4.1.1.1 Rainfall Events During the Field Monitoring Program | 4-2 |
| | 4.1.1.2 Historical Rainfall Characteristics | 4-8 |
| | 4.1.1.2.1 Annual Hydrologic Inputs | 4-8 |
| | 4.1.2 Stormwater Runoff | 4-9 |
| | 4.1.2.1 Computational Methods | 4-9 |
| | 4.1.2.2 Modeled Runoff Volumes | 4-12 |

TABLE OF CONTENTS – CONTINUED

| Section | Page | |
|-----------|---|------------|
| 4.1.3 | Irrigation Inputs | 4-15 |
| 4.1.4 | Shallow Groundwater Seepage | 4-17 |
| 4.1.4.1 | Seepage Meter Construction and Locations | 4-17 |
| 4.1.4.2 | Seepage Meter Monitoring | 4-19 |
| 4.1.4.3 | Seepage Inflow | 4-19 |
| 4.2 | Hydrologic Losses | 4-23 |
| 4.2.1 | Evaporation Losses | 4-24 |
| 4.2.2 | System Discharges | 4-25 |
| 4.3 | Hydrologic Budget | 4-26 |
| 4.3.1 | Hydrologic Inputs | 4-26 |
| 4.3.2 | Hydrologic Losses | 4-28 |
| 4.4 | Water Residence Time | 4-30 |
| 5. | NUTRIENT INPUTS AND LOSSES | 5-1 |
| 5.1 | Characteristics of Nutrient Inputs | 5-2 |
| 5.1.1 | Bulk Precipitation | 5-2 |
| 5.1.1.1 | Chemical Characteristics | 5-2 |
| 5.1.1.2 | Mass Loadings | 5-7 |
| 5.1.2 | Stormwater Loadings | 5-7 |
| 5.1.2.1 | Monitoring Sites | 5-7 |
| 5.1.2.1.1 | Site MI-1 | 5-9 |
| 5.1.2.1.2 | Site MI-2 | 5-12 |
| 5.1.2.1.3 | Site MI-3 | 5-12 |
| 5.1.2.1.4 | Site MI-4 | 5-12 |
| 5.1.2.1.5 | Site MI-5 | 5-16 |
| 5.1.2.1.6 | Reuse Monitoring Site | 5-18 |
| 5.1.2.1.7 | Land Use and Hydrologic Characteristics of Monitored Stormwater Basins | 5-18 |
| 5.1.2.2 | Field and Laboratory Methods | 5-20 |
| 5.1.2.3 | Characteristics of Monitored Runoff and Reuse Samples | 5-21 |
| 5.1.2.4 | Selection of Runoff Characterization Data | 5-31 |
| 5.1.2.5 | Runoff Loadings | 5-33 |
| 5.1.3 | Groundwater Seepage | 5-34 |
| 5.1.3.1 | Chemical Characteristics of Seepage Inflows | 5-34 |
| 5.1.3.2 | Mass Loadings from Seepage Inflows | 5-37 |
| 5.1.4 | Internal Recycling | 5-37 |
| 5.1.4.1 | Field and Laboratory Procedures | 5-38 |
| 5.1.4.2 | Calculation of Mass Release | 5-42 |
| 5.2 | Annual Nutrient Budgets | 5-46 |
| 5.2.1 | Nitrogen Loadings | 5-46 |
| 5.2.2 | Phosphorus Loadings | 5-48 |
| 5.2.3 | Comparison with Other Marine Systems | 5-49 |

TABLE OF CONTENTS – CONTINUED

| Section | | Page |
|----------------|---|-------------|
| 6. | ISOTOPE ANALYSIS OF INPUTS TO MARCO ISLAND WATERWAYS | 6-1 |
| 6.1 | Introduction | 6-1 |
| 6.2 | Theory of Measurement | 6-3 |
| 6.3 | Analysis | 6-5 |
| 6.4 | Results | 6-6 |
| | 6.4.1 Bulk Precipitation | 6-6 |
| | 6.4.2 Reuse Irrigation and Reuse Pond | 6-7 |
| | 6.4.3 Runoff Samples | 6-9 |
| | 6.4.4 Groundwater Seepage | 6-10 |
| 6.5 | Summary | 6-11 |
| 7. | EVALUATION OF WATER QUALITY IMPROVEMENT OPTIONS | 7-1 |
| 7.1 | Management Philosophy | 7-1 |
| | 7.1.1 Water Quality Dynamics and Limitations | 7-1 |
| | 7.1.2 Significance of Nutrient Sources | 7-4 |
| | 7.1.2.1 Sediment Nutrient Recycling | 7-4 |
| | 7.1.2.2 Groundwater Seepage | 7-4 |
| | 7.1.2.3 Stormwater Runoff | 7-5 |
| | 7.1.2.4 Reuse Irrigation | 7-5 |
| | 7.1.2.5 General Management Options | 7-6 |
| 7.2 | Reduction of Loadings from Internal Recycling | 7-6 |
| | 7.2.1 Sediment Dredging | 7-7 |
| | 7.2.1.1 Dredging Materials | 7-7 |
| | 7.2.1.2 Containment Area Requirements | 7-8 |
| | 7.2.1.3 Dredging Costs | 7-9 |
| | 7.2.1.4 Summary | 7-10 |
| 7.3 | Stormwater Management | 7-10 |
| | 7.3.1 Nutrient Management | 7-11 |
| | 7.3.1.1 Swale Blocks | 7-12 |
| | 7.3.1.2 Denitrification Bed | 7-13 |
| | 7.3.1.3 Summary and Recommendations | 7-15 |
| | 7.3.2 Inlet Systems | 7-15 |
| | 7.3.2.1 Summary and Recommendations | 7-17 |
| | 7.3.3 Stormwater Management | 7-18 |
| | 7.3.3.1 Recommendations | 7-19 |
| 7.4 | Seepage Management | 7-19 |
| | 7.4.1 Management Options | 7-19 |
| | 7.4.2 Summary and Recommendations | 7-21 |

TABLE OF CONTENTS – CONTINUED

| Section | | Page |
|----------------|---|-------------|
| 7.5 | Reuse Irrigation | 7-21 |
| | 7.5.1 Overview of Issues | 7-21 |
| | 7.5.2 Groundwater Impacts | 7-22 |
| | 7.5.3 Impacts to Fertilizer Requirements | 7-23 |
| | 7.5.4 Maintenance and Application Issues for Reuse Irrigation | 7-25 |
| | 7.5.5 Golf Course Irrigation | 7-27 |
| | 7.5.6 Summary and Recommendations | 7-30 |
| 7.6 | Improved Recirculation | 7-31 |
| | 7.6.1 Existing Conditions and Issues | 7-31 |
| | 7.6.2 Recirculation Options | 7-32 |
| | 7.6.3 Recommendations | 7-36 |
| 7.7 | Landscape Activities | 7-37 |
| | 7.7.1 Existing Conditions and Issues | 7-37 |
| | 7.7.2 Fertilizer Ordinance | 7-37 |
| | 7.7.3 Citizen Reporting | 7-40 |
| | 7.7.4 Recommendations | 7-40 |
| 7.8 | Non-Structural Techniques | 7-40 |
| | 7.8.1 Street Sweeping | 7-41 |
| | 7.8.1.1 Introduction | 7-41 |
| | 7.8.1.2 Current City Program | 7-43 |
| | 7.8.1.3 Recommendations | 7-44 |
| | 7.8.2 Public Education | 7-44 |
| | 7.8.2.1 Recommendations | 7-45 |
| | 7.8.3 Stormwater Utility | 7-45 |
| | 7.8.4 Water Quality Monitoring Program | 7-45 |
| 7.9 | Regulatory Issues | 7-47 |
| 7.10 | Summary of Recommended Management Options | 7-47 |
| 8. | REFERENCES | 8-1 |

TABLE OF CONTENTS – CONTINUED

Appendices

- A. Historical Water Quality Data for Marco Island and Off-Shore Waterbodies
 - A-1 Historical Water Quality Data for Marco Island Monitoring Sites
 - A-2 Mean Annual Values for Marco Island Monitoring Sites
 - A-3 Temporal Plots and Regression Analyses for Marco Island Historical Monitoring Data
 - A-4 Box and Whisker Plots for Historical Marco Island Water Quality Data by Site
 - A-5 Historical Water Quality Data for Off-Shore Waterbodies
 - A-6 Characteristics of Reuse Irrigation Produced by Marco Island

- B. Results of Surface Water Quality Monitoring Conducted in Marco Island Waterways from April-September 2020
 - B-1 Vertical Field Profiles
 - B-2 Characteristics of Surface Water Samples

- C. Photographs of Sediment Core Samples Collected in Marco Island Waterways

- D. Hydrologic Modeling Used to Calculate Runoff Volumes for Marco Island Sub-basins 1-5

- E. Characteristics of Shallow Groundwater Seepage Collected in Marco Island from April-November 2020
 - E-1 Field Measurements of Seepage Inflow Volumes
 - E-2 Chemical Characteristics of Collected Seepage Samples

- F. Characteristics of Monitored Inputs to Marco Island Waterways from May-October 2020
 - F-1 Bulk Precipitation
 - F-2 Stormwater Runoff
 - F-3 Reuse Irrigation
 - F-4 Reuse Pond on Golf Course

- G. Results of Benthic Sediment Release Experiments
 - G-1 Lab Analyses Conducted During Sediment Release Experiments
 - G-2 Sediment Nutrient Release Plots

- H. Results of Stable Isotope Analyses Conducted on Marco Island Samples
 - H-1 Laboratory Documentation
 - H-2 Sample Results

- I. Marco Island Fertilizer Ordinance

LIST OF FIGURES

| Figure Number / Title | Page |
|---|-------------|
| 1-1 Location Map for Marco Island | 1-1 |
| 1-2 Local Vicinity Map for Marco Island | 1-2 |
| 2-1 WBIDs in the Vicinity of Marco Island | 2-3 |
| 2-2 Locations of Historical Marco Island Water Quality Monitoring Sites | 2-8 |
| 2-3 Mean Annual Total Nitrogen Concentrations in Marco Island Waterways from 2015-2020 | 2-10 |
| 2-4 Mean Annual Total Phosphorus Concentrations in Marco Island Waterways from 2015-2020 | 2-13 |
| 2-5 Mean Annual Chlorophyll-a Concentrations in Marco Island Waterways from 2015-2020 | 2-14 |
| 2-6 Mean Annual Secchi Disk Depths in Marco Island Waterways from 2015-2020 | 2-16 |
| 2-7 Mean Annual Enterococci Counts in Marco Island Waterways from 2015-2020 | 2-17 |
| 2-8 Statistical Comparison of Concentrations of Total Nitrogen and Total Phosphorus Measured in Marco Island Waterways from 2015-2020 | 2-20 |
| 2-9 Statistical Comparison of Concentrations of Chlorophyll-a and Secchi Disk Depth Measured in Marco Island Waterways from 2015-2020 | 2-22 |
| 2-10 Statistical Comparison of Concentrations of Enterococcus Counts in Marco Island Waterways from 2015-2020 | 2-23 |
| 2-11 Overview of Historical Water Quality Monitoring Sites by Other Agencies | 2-24 |
| 2-12 Expanded View of Off-Island Monitoring Sites North of Marco Island Near Isles of Capri | 2-25 |
| 2-13 Statistical Comparison of Measured Values of Total Nitrogen and Total Phosphorus at On- and Off-Island Waterways from 2015-2020 | 2-31 |
| 2-14 Statistical Comparison of Measured Values of Chlorophyll-a and Secchi Disk Depth at On- and Off-Island Waterways from 2015-2020 | 2-32 |

LIST OF FIGURES -- CONTINUED

| Figure Number / Title | Page |
|---|-------------|
| 2-15 Statistical Comparison of Measured Enterococci Counts at On- and Off-Island Waterways from 2015-2020 | 2-34 |
| 2-16 Surface Water Monitoring Sites Used by ERD | 2-36 |
| 2-17 Vertical Field Profiles Collected in Marco Island at Site MI-3 | 2-39 |
| 2-18 Vertical Field Profiles Collected in Marco Island at Site MI-9 | 2-40 |
| 2-19 Vertical Field Profiles Collected in Marco Island at Site MI-11 | 2-41 |
| 2-20 Locations of Sediment Core Monitoring Sites | 2-50 |
| 2-21 Schematic of Chang and Jackson Speciation Procedure for Evaluating Soil Phosphorus Bonding | 2-52 |
| 3-1 Overview of the Marco Island Drainage Basin Area | 3-2 |
| 3-2 Current (June 2020) Land Use in the Marco Island Drainage Basin | 3-5 |
| 3-3 Locations of Marco Island Seawalls | 3-7 |
| 3-4 Hydrologic Soil Groups (HSG) in the Marco Island Drainage Basin | 3-9 |
| 3-5 City of Marco Island Stormsewer System | 3-11 |
| 3-6 Topographic Map of the Marco Island Drainage Basin | 3-12 |
| 3-7 Limited Range Topographic Map for Marco Island | 3-14 |
| 3-8 Photo of the City of Marco Island Wastewater Treatment Facility | 3-15 |
| 3-9 Schematic of the City of Marco Island Wastewater Treatment Process | 3-16 |
| 3-10 Active and Potential Areas for Reuse Irrigation on Marco Island | 3-18 |
| 3-11 Temporal Variability in Marco Island Reuse Water Characteristics from 2012-2021 | 3-23 |
| 3-12 Stormwater Treatment Areas in the Marco Island Drainage Basin | 3-26 |

LIST OF FIGURES -- CONTINUED

| Figure Number / Title | Page |
|--|-------------|
| 3-13 Examples of Delineated Impervious Areas for Residential Parcels | 3-28 |
| 4-1 Conceptual Schematic of Evaluated Hydrologic Inputs and Losses to Marco Island Waterways | 4-1 |
| 4-2 Marco Island Hydrologic Instrumentation | 4-3 |
| 4-3 Graphical Comparison of Field Measured and “Normal” Rainfall from May-November 2020 | 4-7 |
| 4-4 Rear Yard French Drains | 4-13 |
| 4-5 Typical Seepage Meter Installation | 4-18 |
| 4-6 Seepage Meters Being Prepared for Installation | 4-18 |
| 4-7 Locations of Marco Island Seepage Monitoring Sites | 4-20 |
| 4-8 Graphical Comparisons of Annual Hydrologic Inputs to the Marco Island Waterways | 4-27 |
| 4-9 Graphical Comparisons of Annual Hydrologic Losses from the Marco Island Waterways | 4-29 |
| 5-1 Conceptual Schematic of Evaluated Nutrient Inputs and Losses for Marco Island Waterways | 5-1 |
| 5-2 Statistical Comparison of Measured Values for pH, Conductivity, Alkalinity, Color, Turbidity, and TSS in Bulk Precipitation Samples Collected at Marco Island from May-November 2020 | 5-3 |
| 5-3 Statistical Comparison of Measured Values for Nitrogen Species in Bulk Precipitation Samples Collected at Marco Island from May-November 2020 | 5-4 |
| 5-4 Statistical Comparison of Measured Values for Phosphorus Species in Bulk Precipitation Samples Collected at Marco Island from May-November 2020 | 5-6 |
| 5-5 Locations of Stormwater Monitoring Sites | 5-8 |
| 5-6 Overview of the Drainage Basin Areas for Monitoring Sites MI-1 and MI-3 | 5-10 |

LIST OF FIGURES -- CONTINUED

| Figure Number / Title | Page |
|---|-------------|
| 5-7 Photograph of Stormwater Monitoring Site MI-1 | 5-11 |
| 5-8 Overview of the Drainage Basin Area for Monitoring Site MI-2 | 5-13 |
| 5-9 Photograph of Stormwater Monitoring Site MI-2 | 5-14 |
| 5-10 Photograph of Stormwater Monitoring Site MI-3 | 5-14 |
| 5-11 Overview of the Drainage Basin Area for Monitoring Site MI-4 | 5-15 |
| 5-12 Photograph of Stormwater Monitoring Site MI-4 | 5-16 |
| 5-13 Overview of the Drainage Basin Area for Monitoring Site MI-5 | 5-17 |
| 5-14 Photograph of Stormwater Monitoring Site MI-5 | 5-18 |
| 5-15 Photograph of the Reuse Monitoring Site | 5-19 |
| 5-16 Statistical Summary of Measured Values for pH, Alkalinity, and Conductivity in Baseflow, Runoff, and Reuse Samples Collected at Marco Island Monitoring Sites from May-October 2020 | 5-23 |
| 5-17 Statistical Summary of Measured Values for Turbidity, Color, and TSS in Baseflow, Runoff, and Reuse Samples Collected at Marco Island Monitoring Sites from May-October 2020 | 5-24 |
| 5-18 Statistical Summary of Measured Values for Ammonia, NO _x , and Dissolved Organic Nitrogen in Baseflow, Runoff, and Reuse Samples Collected at Marco Island Monitoring Sites from May-October 2020 | 5-26 |
| 5-19 Statistical Summary of Measured Values for Particulate Nitrogen and Total Nitrogen in Baseflow, Runoff, and Reuse Samples Collected at Marco Island Monitoring Sites from May-October 2020 | 5-28 |
| 5-20 Statistical Summary of Measured Values for SRP and Dissolved Organic Phosphorus in Baseflow, Runoff, and Reuse Samples Collected at Marco Island Monitoring Sites from May-October 2020 | 5-29 |
| 5-21 Statistical Summary of Measured Values for Particulate Phosphorus and Total Phosphorus in Baseflow, Runoff, and Reuse Samples Collected at Marco Island Monitoring Sites from May-October 2020 | 5-30 |

LIST OF FIGURES -- CONTINUED

| Figure Number / Title | Page |
|---|-------------|
| 5-22 Large Core Sample Sites for Measurement of Internal Recycling in Marco Marco Island Waterways | 5-39 |
| 5-23 Schematic of Sediment Incubation Apparatus | 5-41 |
| 5-24 Schematic of Sediment Core Incubation System | 5-41 |
| 5-25 Graphical Comparison of Nitrogen Sources for the Five Marco Island Sub-basin Waterways | 5-47 |
| 5-26 Graphical Comparison of Phosphorus Sources for the Five Marco Island Sub-basin Waterways | 5-50 |
| 6-1 Separation of Isotopes by Gas Isotope-Ratio Mass Spectrometry | 6-3 |
| 6-2 Relationships Between $\delta^{15}\text{N}$ and $\delta^{18}\text{O}$ for Bulk Precipitation Samples Collected at Marco Island | 6-7 |
| 6-3 Relationships Between $\delta^{15}\text{N}$ and $\delta^{18}\text{O}$ for Reuse Irrigation and Reuse Pond Samples Collected at Marco Island | 6-8 |
| 6-4 Relationships Between $\delta^{15}\text{N}$ and $\delta^{18}\text{O}$ for Stormwater and Baseflow Samples Collected at Marco Island | 6-10 |
| 6-5 Relationships Between $\delta^{15}\text{N}$ and $\delta^{18}\text{O}$ for Groundwater Seepage Samples Collected at Marco Island | 6-12 |
| 7-1 Photographs of Observed Water Quality Issues | 7-3 |
| 7-2 Typical Gassed Swale Systems Used at Marco Island | 7-11 |
| 7-3 Example of a Typical Swale Block | 7-12 |
| 7-4 Schematic of Denitrification Process | 7-13 |
| 7-5 Example of Denitrification Bed Incorporated into Existing Swales | 7-14 |
| 7-6 Schematic of Inlet Filter System Installed at Marco Island | 7-16 |
| 7-7 Solids Collected from Inlet Baskets by City Personnel | 7-17 |

LIST OF FIGURES -- CONTINUED

| Figure Number / Title | Page |
|--|-------------|
| 7-8 Typical Rain Garden Layout | 7-18 |
| 7-9 Photographs of Rain Gardens | 7-19 |
| 7-10 Example of Denitrification Bed Incorporated into Seawalls | 7-20 |
| 7-11 Reuse Water Applications | 7-26 |
| 7-12 Proposed Area Options for Recirculation Improvements | 7-32 |
| 7-13 Proposed Location for Site 1 Interconnection | 7-33 |
| 7-14 Proposed Location for Site 2 Interconnection | 7-33 |
| 7-15 Proposed Location for Site 3 Interconnection | 7-34 |
| 7-16 Proposed Location for Sites 4 and 5 Interconnection | 7-35 |
| 7-17 Proposed Location for Site 6 Interconnection | 7-35 |

LIST OF TABLES

| Table Number / Title | Page |
|---|-------------|
| 2-1 Numeric Nutrient Criteria for Marco Island | 2-2 |
| 2-2 Verified Water Quality Impairments for Marco Island and Adjacent Waterbodies | 2-4 |
| 2-3 Summary of Historical Water Quality Data for Island Monitoring Sites | 2-6 |
| 2-4 Overall Mean Values for Historical Marco Island Monitoring Sites from 2015-2020 | 2-11 |
| 2-5 Trendline Slopes and Level of Significance for Marco Island Monitoring Sites From 2015-2020 | 2-18 |
| 2-6 Summary of Historical Water Quality Data for Off-Island Monitoring Sites | 2-26 |
| 2-7 Annual Geometric Mean Values for Water Quality Data in Waterbodies Adjacent to Marco Island from 2015-2020 | 2-29 |
| 2-8 Historical Enterococci Data for Waterbodies Adjacent to Marco Island | 2-33 |
| 2-9 Analytical Methods and Detection Limits for Field and Laboratory Analyses Conducted by Environmental Research & Design, Inc. | 2-37 |
| 2-10 Summary of Vertical Profile Data Collected at Marco Island from April-September 2020 | 2-43 |
| 2-11 Water Quality Characteristics of Off-Island Surface Water Samples Collected During Incoming and Outgoing Tidal Conditions from April-September 2020 | 2-44 |
| 2-12 Water Quality Characteristics of Island Waterway Surface Water Samples Collected During Incoming and Outgoing Tidal Conditions from April-September 2020 | 2-46 |
| 2-13 Geometric Mean Water Quality Characteristics of Surface Water Samples Collected at Off-Island Sites from April-September 2020 | 2-47 |
| 2-14 Geometric Mean Water Quality Characteristics of Surface Water Samples Collected at Island Waterway Sites from April-September 2020 | 2-48 |
| 2-15 Analytical Methods for Sediment Analyses | 2-51 |

LIST OF TABLES -- CONTINUED

| Table Number / Title | Page |
|--|-------------|
| 2-16 Visual Characteristics of Sediment Core Samples Collected in Marco Island Waterways on April 29 and May 25, 2020 | 2-55 |
| 2-17 General Characteristics of Sediment Core Samples Collected in Marco Island During 2020 | 2-56 |
| 2-18 Phosphorus Speciation in Sediment Core Samples Collected at Marco Island During April and May 2020 | 2-57 |
| 2-19 Comparison of Sediment Characteristics by Sub-basin and Off-Island Areas | 2-59 |
| 3-1 Sub-basin Areas Discharging to Marco Island | 3-3 |
| 3-2 Current (June 2020) Land Use Characteristics in the Marco Island Watershed | 3-6 |
| 3-3 Surface Areas of Canals and Waterways in the Primary Marco Island Sub-basins | 3-6 |
| 3-4 Characteristics of SCS Hydrologic Soil Group Classifications | 3-8 |
| 3-5 Hydrologic Soil Groups in the Marco Island Watershed | 3-10 |
| 3-6 Summary of Average Daily Inflow Rates for the Marco Island and Marco Shores WWTPs from 2011-2020 | 3-15 |
| 3-7 Summary of Reclaimed Water and Supplied Water Consumption by Reuse Customers | 3-17 |
| 3-8 Summary of Reuse Water Application and Disposal for the Marco Island WWTP from 2011-2020 | 3-19 |
| 3-9 Marco Island Reclaimed Water Storage Facility Inventory | 3-20 |
| 3-10 Summary of Major Reuse Water Users for the Marco Island and Marco Shores WWTPs from 2011-2020 (>0.1 MGD) | 3-20 |
| 3-11 Summary of Reported Reuse Irrigation Areas and Volumes for the Marco Island and Marco Shores WWTPs from 2011-2020 | 3-21 |
| 3-12 Reuse Application Rates for Golf Course and Public Access Areas from 2015-2020 | 3-21 |

LIST OF TABLES -- CONTINUED

| Table Number / Title | Page |
|--|-------------|
| 3-13 Summary Statistics for Marco Island Reuse Irrigation from 2012-2021 | 3-24 |
| 3-14 Annual Geometric Mean Values for Marco Island Reuse Irrigation from 2012-2021 | 3-24 |
| 3-15 Hydrologic Characteristics of the Marco Island Drainage Basin | 3-30 |
| 4-1 Measured Rainfall at the Marco Island Monitoring Site from May 1-November 30, 2020 | 4-4 |
| 4-2 Comparison of Field Measured Rainfall and “Normal” Rainfall from May-November 2020 | 4-7 |
| 4-3 Summary of Mean Monthly Rainfall at the Marco Island Meteorological Site (USC00085359) from 1991-2020 | 4-8 |
| 4-4 Mean Monthly Precipitation Inputs to Marco Island Waterways | 4-9 |
| 4-5 Estimated Volumetric Removal Efficiencies for Wetlands and Stormwater Management Systems in the Marco Island Drainage Basins | 4-12 |
| 4-6 Summary of Generated and Delivered Runoff Volumes for Marco Island Sub-Basin Areas | 4-14 |
| 4-7 Pervious and Impervious Areas in Sub-basins with and without Reuse Irrigation | 4-16 |
| 4-8 Annual Reuse and Non-Reuse Irrigation Volumes by Sub-basin | 4-16 |
| 4-9 Field Measured Hydrologic Inputs to Marco Island Waterways from Groundwater Seepage from May-November 2020 | 4-22 |
| 4-10 Mean Seepage Values by Sub-basin | 4-22 |
| 4-11 Hydrologic Balance for Seepage Inflows to Marco Island Waterways | 4-23 |
| 4-12 Mean Monthly Lake Evaporation at the Tamiami Trail Station Site | 4-24 |
| 4-13 Mean Monthly and Annual Evaporation Losses from Marco Island Waterways | 4-25 |
| 4-14 Mean Annual Hydrologic Inputs to Marco Island Sub-basins 1-5 | 4-26 |

LIST OF TABLES -- CONTINUED

| Table Number / Title | Page |
|--|-------------|
| 4-15 Mean Annual Hydrologic Losses from Marco Island Sub-basins 1-5 | 4-28 |
| 4-16 Mean Annual Residence Times in Marco Island Waterways | 4-30 |
| 5-1 Summary Statistics for Bulk Precipitation Samples Collected at Marco Island from May-November 2020 | 5-5 |
| 5-2 Annual Nutrient Loadings to Marco Island Waterways from Bulk Precipitation | 5-7 |
| 5-3 Summary of Marco Island Stormwater Monitoring Sites | 5-9 |
| 5-4 Summary of Land Use Characteristics in the Monitored Stormwater Basins | 5-19 |
| 5-5 Hydrologic Characteristics of the Monitored Stormwater Basins | 5-20 |
| 5-6 Geometric Mean Values for Stormwater and Reuse Samples Collected at Marco Island from June-October 2020 | 5-21 |
| 5-7 Summary of Geomean Values for Stormwater Monitoring Sites | 5-32 |
| 5-8 Calculated Annual and Areal Loadings of Total Nitrogen and Total Phosphorus From Sub-basin Areas to Marco Island Waterways | 5-33 |
| 5-9 Geometric Mean Characteristics of Seepage Inflows at Marco Island from April-November 2020 | 5-34 |
| 5-10 Mean Seepage Characteristics by Sub-basin | 5-36 |
| 5-11 Mean Seepage Characteristics in Areas with and without Reuse Irrigation | 5-36 |
| 5-12 Calculated Annual Seepage Loading to Marco Island Waterways | 5-37 |
| 5-13 Measured Experimental Sediment Release Rates at Marco Island | 5-43 |
| 5-14 Measured Experimental Sediment Release Rates at Marco Island by Sub-basin | 5-44 |
| 5-15 Calculated Annual Sediment Release of Total Nitrogen and Total Phosphorus in Marco Island Waterways | 5-46 |
| 5-16 Estimated Annual Mass Loadings of Total Nitrogen to Marco Island Waterbodies | 5-48 |

LIST OF TABLES -- CONTINUED

| Table Number / Title | Page |
|--|-------------|
| 5-17 Estimated Annual Mass Loadings of Total Phosphorus to Marco Island Waterbodies | 5-49 |
| 5-18 Summary of Annual Areal Total Nitrogen Loading Rates for Estuarine and Coastal Systems | 5-51 |
| 6-1 Typical Values and Ranges for $\delta^{15}\text{N}$ and $\delta^{18}\text{O}$ from Various Sources of Nitrogen Loading | 6-2 |
| 6-2 Summary of Isotope Analyses Conducted on Marco Island Samples | 6-5 |
| 6-3 Summary Statistics for Isotope Analyses Conducted on Bulk Precipitation Samples | 6-6 |
| 6-4 Summary Statistics for Isotope Analyses Conducted on Reuse Irrigation and Reuse Pond Samples | 6-8 |
| 6-5 Summary Statistics for Isotope Analyses Conducted on Runoff/Baseflow Samples | 6-9 |
| 6-6 Summary Statistics for Isotope Analyses Conducted on Groundwater Seepage Samples | 6-11 |
| 7-1 Geometric Mean Concentrations at Off-Shore Monitoring Sites from April-September 2020 | 7-2 |
| 7-2 Comparison of Geomean Total Nitrogen Concentrations in Significant Seepage Sources | 7-6 |
| 7-3 Summary of Dredging Design Assumptions and Containment Area Requirements for Marco Island | 7-9 |
| 7-4 Estimated Costs for Hydraulic Dredging of Marco Island Sediments | 7-10 |
| 7-5 Analysis of Nutrient Load Reductions by the Inlet Basket Systems | 7-17 |
| 7-6 Hydrologic Budget for Marco Island Turfgrass | 7-22 |
| 7-7 Annual Mass of Nitrogen and Phosphorus Supplied by Marco Island Reuse Irrigation Applied at Various Weekly Rates | 7-24 |

LIST OF TABLES -- CONTINUED

| Table Number / Title | Page |
|---|-------------|
| 7-8 Recommended Annual Fertilizer Application Rates for South Florida Turfgrasses | 7-24 |
| 7-9 Percentage of Annual St. Augustine Grass Fertilization Requirements Supplied by Marco Island Reuse Irrigation | 7-25 |
| 7-10 Impacts from Overspray of Marco Island Reuse Irrigation | 7-26 |
| 7-11 Comparison of Geomean Characteristics of Reuse and Golf Course Pond Water Used for Irrigation | 7-27 |
| 7-12 Recommended Annual Fertilizer Application Rates for Bermudagrass in South Florida | 7-29 |
| 7-13 Percentage of Annual Bermudagrass Fertilization Requirements Supplied by Golf Course Reuse Irrigation | 7-29 |
| 7-14 Hydrologic Budget for Golf Course Bermudagrass | 7-30 |
| 7-15 Estimated Costs for Horizontal Directional Drilling for Canal Interconnections | 7-36 |
| 7-16 Efficiencies of Mechanical (Broom) and Vacuum-Assisted Sweepers | 7-42 |
| 7-17 Results of Street Sweeper Efficiency Experiments with a Pelican Series P Mechanical Sweeper and a Johnston 605 Series Vacuum Sweeper, by Particle Size | 7-43 |
| 7-18 Recommended Management Options for Marco Island | 7-50 |

LIST OF ABBREVIATIONS AND UNITS OF MEASURE

The following abbreviations, acronyms, units of measure, and symbols are used in this report:

| ABBREVIATION | MEANING |
|-----------------|---|
| AGM | Annual Geometric Mean |
| BAM | Biologically Activated Media |
| BMAP | Basin Management Action plan |
| BMP | Best Management Practice |
| City | City of Marco Island |
| CN | Hydrologic Curve Number |
| CTS | Clay, Tire Crumb, and Sand |
| CWA | Clean Water Act |
| DCIA | Directly Connected Impervious Area |
| DIN | Dissolved Inorganic Nitrogen |
| ERD | Environmental Research & Design, Inc. |
| ET | Evapotranspiration |
| FAC | Florida Administrative Code |
| FDACS | Florida Department of Agriculture and Consumer Services |
| FDEP | Florida Department of Environmental Protection |
| FDOH | Florida Department of Health |
| FLUCCS | Florida Land Use Cover and Classification System |
| FS | Florida Statute |
| FSA | Florida Stormwater Association |
| GIS | Geographic Information System |
| HDD | Horizontal Directional Drilling |
| HDPE | High-Density Polyethylene |
| HDR | High-Density Residential |
| HSG | Hydrologic Soil Group |
| IFAS | Institute of Food and Agricultural Sciences |
| LCFAC | Limited Commercial Fertilizer Applicator Certification |
| LID | Low Impact Development |
| LIDAR | Laser Imaging, Detection, and Ranging |
| MDR | Medium-Density Residential |
| MGD | Million Gallons per Day |
| NAVD88 | North American Vertical Datum of 1988 |
| NH ₄ | Ammonia |
| NNC | Numeric Nutrient Criteria |
| NO _x | Nitrite + Nitrate |
| NO ₂ | Nitrite |
| NO ₃ | Nitrate |
| O | Oxygen |
| ORP | Oxidation Reduction Potential |
| % | Percent |
| p-value | Probability Value |
| PUD | Planned Urban Development |
| PVC | Poly Vinyl Chloride (as in pipes) |
| RFP | Request for Proposal |
| RIB | Rapid Infiltration Basin |

LIST OF ABBREVIATIONS AND UNITS OF MEASURE -- CONTINUED

| ABBREVIATION | MEANING |
|--------------|---|
| ROW | Right-of-Way |
| RWPF | Reclaimed Water Production Facility |
| SCS | Soil Conservation Service |
| SIF | Stable Isotope Facility at University of California-Davis |
| SRP | Soluble Reactive Phosphorus |
| STORET | Florida Storage and Retrieval Database |
| SFWMD | South Florida Water Management District |
| TKN | Total Kjeldahl Nitrogen |
| TN | Total Nitrogen |
| TP | Total Phosphorus |
| TSS | Total Suspended Solids |
| TMDL | Total Maximum Daily Loads |
| US EPA | U.S. Environmental Protection Agency |
| USGS | U.S. Geological Survey |
| WBID | Water Body Identification Number |
| WIN | Watershed Information Network |
| WWTP | Wastewater Treatment Plant |
| W&SD | Water and Sewer Department |

Units of Measurement

| UNIT | MEANING |
|--|---------------------------------------|
| ac | Acre |
| ac-ft | Acre-Feet |
| ac-ft/yr | Acre-Feet per Year |
| cfu | Colony Forming Units |
| cfs | Cubic Feet per Second |
| cm | Centimeter |
| ft, ft ² , or ft ³ | Foot/Feet, Square Feet, or Cubic Feet |
| gal/yr | Gallons per Year |
| in/hr | Inches per Hour |
| l or L | Liter |
| lbs | Pounds |
| lbs/yr | Pounds per Year |
| in/wk | Inches per Week |
| m, m ² , or m ³ | Meter, Square Meter, or Cubic Meter |
| MGD | Million Gallons per Day |
| mg/l | Milligrams per Liter |
| µg/l | Micrograms per Liter |
| µmho/cm | Micromoh per Centimeter |
| mi | Miles |
| NTU | Nephelometric Turbidity Units |
| % | Percent |
| % by wt. | Percent by Weight |
| Pt-Co | Platinum Cobalt Unit |
| s.u. | Standard Unit (measure of pH) |
| yd, yd ² , or yd ³ | Yard, Square Yard, or Cubic Yard |

SECTION 1

INTRODUCTION

1.1 General Description

This report provides a summary of work efforts performed by Environmental Research & Design, Inc. (ERD) for the City of Marco Island (City) to evaluate historical and current water quality characteristics, develop hydrologic and nutrient budgets, and a water quality management plan for Marco Island waterways. The City of Marco Island is a 15.6 mi² area located in southern Collier County about 20 miles south of Naples, and is the largest Barrier Island within southwest Florida's Ten Thousand Islands. A location map for Marco Island is given on Figure 1-1, with a local vicinity map given on Figure 1-2.

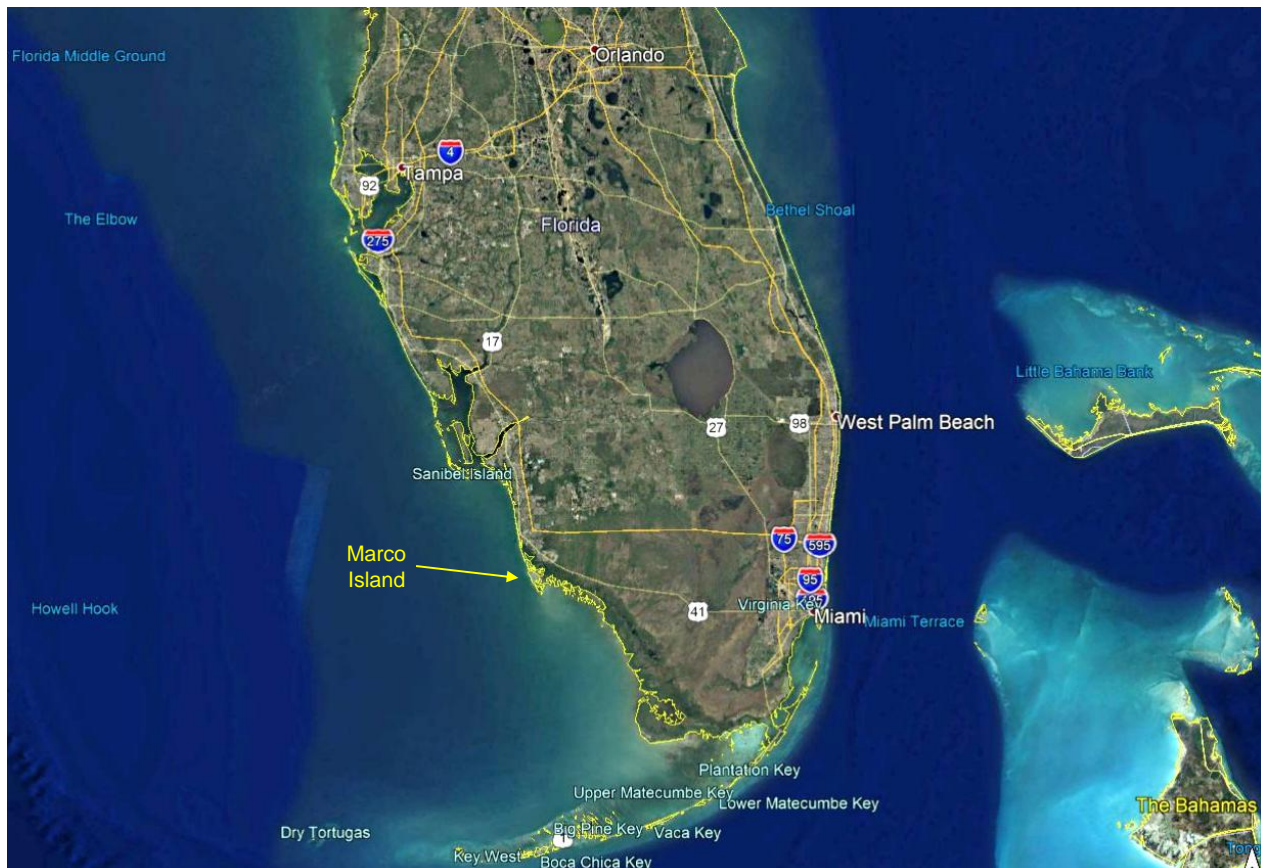

Figure 1-1. Location Map for Marco Island

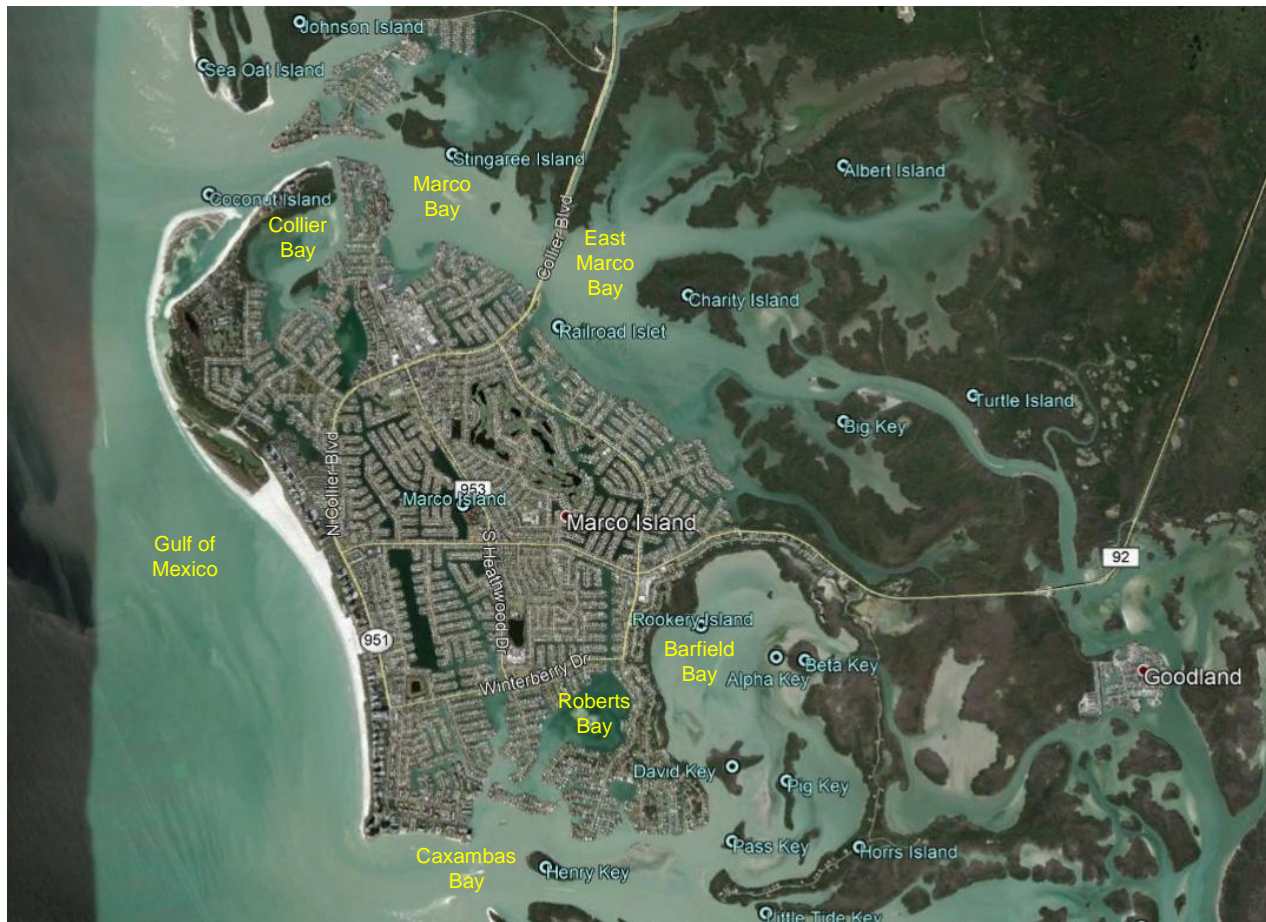

Figure 1-2. Local Vicinity Map for Marco Island.

Major development activities on Marco Island were initiated in the early 1960s which included dredging of the extensive canal system. Currently, the City has over 100 miles of internal and external waterways which are used extensively by residents and visitors for a variety of recreational activities. The current population of Marco Island is approximately 18,000 people, although there is a large seasonal variability, with the largest numbers during the mild fall and winter seasons.

As indicated on Figure 1-2, most of the island is currently developed with only a few vacant residential lots remaining. Most of the island, with the exception of the primary commercial corridors, uses a grassed swale system for runoff conveyance, and formal stormwater treatment systems are limited primarily to commercial and multi-family properties. Virtually all areas within the City have a central sewer system for collection and disposal of sanitary wastes with treated wastewater used for reuse irrigation.

In recent years, citizens have become concerned about declining water quality, both visually and chemically, in the extensive canal and waterway system which is an integral part of the City and provides direct access to off-shore waters for many residents. Routine monitoring of on-island and off-shore waters was initiated in 2004 to document current conditions and provide a database to document changes in water quality over time. Multiple efforts have been undertaken to reduce loadings to the waterways, including regulations for landscaping and fertilizer use and structural controls such as inlet inserts designed to capture suspended solids.

1.2 Impaired Waters Designation

Section 303(d) of the Clean Water Act (CWA) requires states to submit lists of surface waterbodies that do not meet applicable water quality standards. These waterbodies are defined as “impaired waters” and Total Maximum Daily Loads (TMDLs) must be established for these waters on a prioritized schedule. The Florida Department of Environmental Protection (FDEP) and the US EPA have established a series of guidelines to identify impaired waters which may require the establishment of TMDLs. Waterbodies within the State of Florida have been divided into five separate groups for planning purposes, with Marco Island and adjacent off-shore waters located in the Southwest Coast Planning Unit of the Everglades West Coast Basin in Group 1.

During November 2019, the revised and re-adopted Verified List of impaired waterbodies for the Everglades West Coast Basin was released by FDEP and included Marco Island and areas southeast of the Island which include Barfield Bay and Caxambas Bay. The 2019 Verified List indicates that Marco Island (WBID 3278O) is listed as impaired for nutrients (nitrogen) based upon annual geometric mean total nitrogen concentrations exceeding 0.30 mg/l during 2017 and 2018. Total nitrogen was stated to be the limiting nutrient within the waterways. The FDEP priority for TMDL development for Marco Island is “medium” which means that TMDL development is likely 5-10 years away. Areas southeast of Marco Island (WBID 3278P) are listed as impaired for total nitrogen, total phosphorus, and fecal coliform due to exceedances of the applicable criteria for these parameters in recent years.

1.3 Previous Water Quality Studies

Multiple studies and evaluations of water quality data for Marco Island have been conducted since 2004 when data collection was initiated. Annual reports and water quality summaries have been conducted by the Waterways Committee which generally address compliance with water quality standards or compare water quality in island and off-shore areas, and this information is available on the City website.

During February 2019, a report was issued by Turrell, Hall, and Associates, Inc. (Turrell) of Naples which contained a discussion and analysis of water quality data collected from 2015-2018. This report provided a comparison of current and historical water quality at the island monitoring sites and discussed Numeric Nutrient Criteria (NNC) and applicability to Marco Island. The study also provided a brief discussion of potential nutrient sources to the island waterways and general methods to reduce non-point source pollution from runoff.

1.4 Work Efforts Performed by ERD

During October 2019, the City issued a Request for Proposal for RFP #19-033 (Consulting Services for Nutrient Source Evaluation and Assessment) which solicited proposals from qualified consultants to evaluate nutrient sources and provide recommendations for water quality improvement. ERD was selected by the City, and a Scope of Work and project schedule were developed and approved by the City Commission. Work efforts were initiated on this project by ERD during April 2020. The primary objectives of this project are to evaluate current and historical water quality characteristics of Marco Island waterways and off-shore waters; and to conduct a 6-month monitoring program to document water quality of surface water, runoff, bulk precipitation, groundwater seepage, and reuse irrigation, along with sediments and sediment nutrient release. The collected information was used to develop hydrologic and nutrient loadings for identified inputs to surface waters and develop recommendations for water quality improvement.

A field monitoring program was conducted by ERD from April-November 2020 to identify ambient water quality characteristics and collect hydrologic and water quality data for use in developing hydrologic and nutrient budgets for the waterways. The hydrologic budget includes estimated inputs from precipitation, stormwater runoff, irrigation inputs, and groundwater seepage. The nutrient budget includes inputs from bulk precipitation, stormwater runoff, irrigation inputs, groundwater seepage, and internal recycling. A detailed evaluation of sediment characteristics in Marco Island waterways was also conducted which included physical and chemical characterization of surficial sediments and evaluation of internal nutrient recycling.

Although detailed evaluations of hydrologic and nutrient budgets are common in freshwater lakes, similar studies for coastal waterways are relatively rare. Some Florida studies have been conducted to evaluate individual components of hydrologic and nutrient budgets in estuaries or coastal areas, but ERD is not aware of any previous coastal waterway study which incorporates all of the components evaluated in this study.

This report has been divided into 8 separate sections for presentation of the work efforts performed by ERD. Section 1 contains an introduction to the report and provides a general overview of the work efforts performed by ERD. Historical and current water quality characteristics of Marco Island and off-shore waters are discussed in Section 2, including sediment characteristics, historical and current water quality, and water quality criteria. A discussion of the drainage basin area is given in Section 3, and the hydrologic budget is presented in Section 4. A nutrient budget, which includes inputs from total nitrogen, and total phosphorus, is given in Section 5. The results of stable isotope analyses conducted on runoff, bulk precipitation, reuse, and seepage samples are presented in Section 6. A discussion of water quality management and improvement options is given in Section 7, with cited references listed in Section 8. Appendices are also attached which contain technical data and analyses used to support the information contained within the report.

SECTION 2

WATER QUALITY CRITERIA AND CHARACTERISTICS

This section provides a discussion of historical and current water quality characteristics within the Marco Island waterways and adjacent off-shore waterbodies. This information is used as part of an overall assessment to identify potential driving forces which impact water quality in Marco Island and off-shore waters. A discussion of current regulatory water quality criteria for Marco Island waterways is followed by an analysis of historical water quality data for Marco Island and off-shore waterbodies. A discussion of ambient water quality monitoring conducted by ERD specifically for this project is also included, along with a discussion of monitored sediment characteristics.

2.1 Regulatory Water Quality Criteria

2.1.1 Water Quality Criteria

Regulation of water quality criteria within the State of Florida is directed by the Florida Department of Environmental Protection (FDEP). Specific surface water quality standards are outlined in Chapter 62-302 of the Florida Administrative Code (FAC) in the document titled "Surface Water Quality Standards". This document outlines surface water quality criteria for waterbodies throughout the State of Florida. The document was originally implemented in 1979 and is updated on a periodic basis as additional water quality criteria are approved.

For purposes of assigning and implementing water quality criteria, surface waters in the State of Florida have been divided into 5 separate classifications according to designated uses as follows:

| | |
|--------------------|---|
| Class I: | Potable water supplies |
| Class I-Treated: | Treated potable water supplies |
| Class II: | Shellfish propagation or harvesting |
| Class III: | Fish consumption; recreation, propagation, and maintenance of a healthy well-balanced population of fish and wildlife |
| Class III-Limited: | Fish consumption; recreation or limited recreation; and/or propagation and maintenance of a limited population of fish and wildlife |
| Class IV: | Agricultural water supplies |
| Class V: | Navigation, utility, and industrial use |

The classifications listed are arranged in order of the degree of protection required for the stated surface waters, with Class I waters generally having the most stringent water quality criteria and Class V the least. Surface waters on Marco Island and adjacent off-shore waterbodies are considered to be Class II waters which are used for shellfish propagation or harvesting and have some of the most stringent water quality criteria.

Numeric and narrative surface water quality criteria for each of the 5 classifications are outlined in Chapter 62-302.530 FAC titled “Surface Water Quality Criteria”. This section essentially consists of a table which summarizes applicable water quality criteria for each of the 5 classifications for a wide variety of general parameters, metals, organic parameters, and microbiological parameters. Although this table includes more than 100 individual parameters, only a few are commonly monitored in surface waters in the vicinity of Marco Island. The most significant parameters in this table which impact Marco Island waterbodies are dissolved oxygen and Enterococci bacteria.

Numeric Nutrient Criteria (NNC) for Florida waterbodies are outlined in Chapter 62-302.532 FAC titled “Estuary-Specific Nutrient Interpretations of the Narrative Nutrient Criteria”. Water quality criteria are provided for total phosphorus, total nitrogen, and chlorophyll-a based upon the location of the estuary. The Marco Island area is listed under the heading of Rookery Bay/Marco Island, and applicable NNC are summarized in Table 2-1. These criteria are compared with annual geometric mean values for data collected during an individual calendar year to evaluate water quality compliance. Annual Geometric Mean (AGM) calculations must include at least 4 temporarily independent samples per year, collected at least 1 week apart, with at least 1 sample collected between May 1-September 30 and at least 1 sample collected during the remaining months of the calendar year. Annual geometric mean values shall not exceed the NNC outlined in Table 2-1 more than once during 3-year period.

TABLE 2-1

NUMERIC NUTRIENT CRITERIA FOR MARCO ISLAND

| PARAMETER | UNITS | CRITERIA |
|------------------|--------------|-----------------|
| Total Phosphorus | µg/l | 46 |
| Total Nitrogen | µg/l | 300 |
| Chlorophyll-a | µg/l | 4.9 |

The criteria listed in Table 2-1 were developed by FDEP using the “reference site” approach which identifies a similar area with little or no human impact and uses water quality characteristics in the reference area as the criteria for other areas. The appropriateness of this method and applicability of the criteria to Marco Island have been debated in previous documents, such as the 2019 report by Turrell, Hall, and Associates and in presentations by Eugene Wordehoff.

2.1.2 Impaired Waters

Section 303(d) of the Clean Water Act (CWA) requires states to submit lists of surface waterbodies that do not meet applicable water quality standards. These waterbodies are defined as “Impaired Waters” and Total Maximum Daily Loads (TMDLs) must be established for these waters on a prioritized schedule. FDEP has established a series of guidelines to identify impaired waters which may require the establishment of MDLs. Waterbodies within the State of Florida have been divided into 5 separate groups for planning purposes, with Marco Island located in the Southwest Coast Planning Unit of the Everglades West Coast in Group 1.

FDEP has assigned waterbodies in Florida a Water Body Identification number (WBID) which is intended to represent waterbodies in the watershed or sub-watershed scale. WBIDs have a unique identification number that is tracked by FDEP, and the WBIDs are used in the annual assessment of impaired waters, implementation of TMDLs, and Basin Management Action Plans (BMAPs). An overview of WBIDs in the vicinity of Marco Island is given in Figure 2-1. The majority of Marco Island, excluding shoreline areas along the west and southwest portions of the island, is located in WBID 3278O.

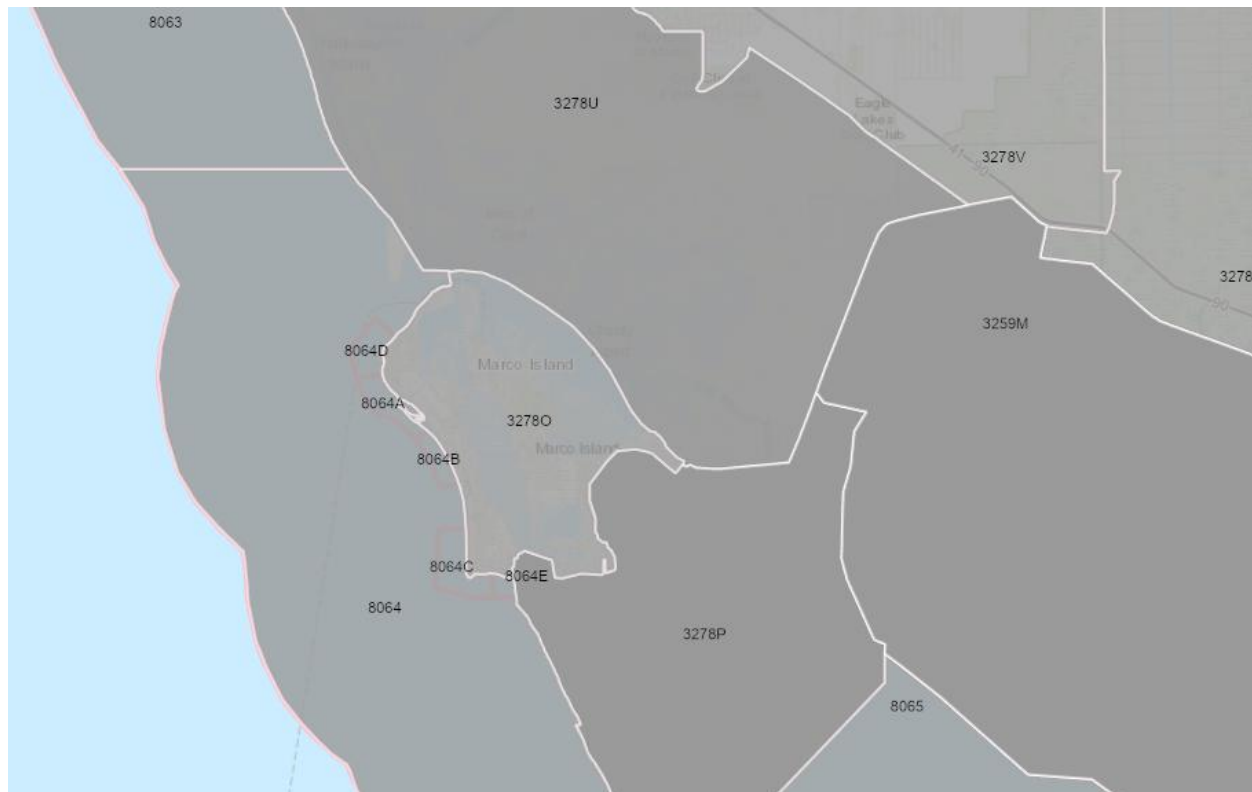

Figure 2-1. WBIDs in the Vicinity of Marco Island.

A summary of verified water quality impairments for Marco Island and adjacent waterbodies is given in Table 2-2 based upon information provided in the Comprehensive Verified Impaired Water List, dated 8/18/2020. Marco Island waterways (designated as WBID 32780) are listed as impaired for total nitrogen due to annual geometric means exceeding 300 µg/l. WBID 3278P (located southeast of Marco Island) is listed as impaired for fecal coliform, total nitrogen, and total phosphorus due to annual geometric mean values for these parameters exceeding applicable limits. WBID 3278U (located northeast of Marco Island and referred to as Rookery Bay) is designated as impaired for fecal coliform, while WBID 8063 (located west of WBID 3278U but also designated as Rookery Bay) is listed as impaired for total nitrogen based upon AGM values exceeding 250 µg/l which is the standard for open water portions of the Gulf of Mexico. WBID 8064 (consisting of the Gulf of Mexico adjacent to Marco Island) is also listed as impaired for total nitrogen due to AGM values exceeding 250 µg/l.

TABLE 2-2
VERIFIED WATER QUALITY IMPAIRMENTS
FOR MARCO ISLAND AND ADJACENT WATERBODIES

| WBID | DESCRIPTION | IMPAIRMENT | CRITERION NOT MET |
|-------|-------------------------------|------------------|---------------------|
| 32780 | Marco Island | Total Nitrogen | AGM \leq 300 µg/l |
| 3278P | Marco Island South Segment | Fecal Coliform | > 400 cfu/100 ml |
| | | Total Nitrogen | AGM \leq 300 µg/l |
| | | Total Phosphorus | AGM < 46 µg/l |
| 3278U | Rookery Bay | Fecal Coliform | > 400 cfu/100 ml |
| 8063 | Gulf of Mexico / Rookery Bay | Total Nitrogen | AGM \leq 250 µg/l |
| 8064 | Gulf of Mexico / Marco Island | Total Nitrogen | AGM \leq 250 µg/l |

2.2 Historical Water Quality Characteristics

2.2.1 Marco Island Waterways

2.2.1.1 Data Availability

Limited water quality monitoring has been conducted within the Marco Island waterways since approximately 2001. At that time, the City chose 12 monitoring locations which were spatially distributed over the island to include primary waterways and drainage basin areas. The frequency of monitoring at these sites has varied over time from monthly, to bi-monthly, to quarterly.

A more intensive water quality monitoring program was initiated in 2007, and the 12 sites were sampled bi-monthly for Total Kjeldahl Nitrogen (TKN) and Enterococcus bacteria. As pointed out in the 2019 water quality analysis conducted by Terrell, Hall, and Associates, Inc., monitoring data generated during the monitoring program from 2007-2014 were not collected using approved field monitoring protocol, and the data are not considered reliable. Beginning in 2015, sampling was continued at the 12 monitoring sites using an approved field monitoring protocol and manual, and the monitoring frequency was changed to a quarterly collection interval at all 12 sites. The collected data were periodically uploaded into the Florida Storage and Retrieval Database (STORET) system until 2016 when the State retired the STORET system and introduced the new Watershed Information Network (WIN) which provides a modernized centralized data management platform as a successor to STORET.

Available historical water quality data were obtained by ERD from the City of Marco Island, STORET, and the WIN database for use with this project. The data were perused by ERD to remove duplicate entries and to flag data entries which appear unlikely or impossible.

A summary of available historical water quality data for Marco Island monitoring sites is given in Table 2-3. These sites include the original 12 monitoring sites, along with 3 additional sites added in recent years, for a total of 15 island waterway monitoring sites. Most of the sites summarized on Table 2-3 have data for the period from 2007-2014 which consists primarily of TKN and Enterococcus. However, due to the potential quality control issues mentioned previously, these data are excluded from the data set, and only data collected from 2015 through the end of 2020 are included in the analysis conducted by ERD.

Locations of Marco Island water quality monitoring sites included in the historical data are illustrated on Figure 2-2. The monitoring sites are located throughout the island and include both upstream and downstream portions of the extensive canal system. Data used for this analysis include data collected from 2015-2020, with reported values for general parameters, field parameters, nutrients, microbiological parameters, and Secchi disk depth. One of the original 12 monitoring sites, referred to as “Perrine” was deleted from the monitoring program during 2017. However, supplemental monitoring sites, referred to as “Landmark”, “Olde Marco”, and “Swallow” were added as replacement sites, comprising a total of 14 current monitoring sites in the active water quality monitoring program.

2.2.1.2 Data Analysis

A complete listing of historical water quality data for Marco Island waterbodies from 2007-2020, depending upon data availability, is given in Appendix A-1, although data collected from 2007-2014 are not included in the analyses discussed in this section. Data which appear to be anomalies, reflect impossible values, or are far out of line with other historical values are highlighted in **yellow** and are not used in statistics analyses.

TABLE 2-3
SUMMARY OF HISTORICAL WATER QUALITY
DATA FOR ISLAND MONITORING SITES

| COLLECTING AGENCY | STATION I.D. | PERIOD OF RECORD | MONITORING FREQUENCY | NUMBER OF EVENTS | TYPE OF DATA |
|----------------------|-----------------------|------------------|----------------------|------------------|--|
| City of Marco Island | Barfield Bridge | 5/07-12/20 | Quarterly to Monthly | 95 | 2007-2014: TKN, Enterococcus 2015-2020: General Parameters, Field Parameters, Nutrients, Micro Parameters |
| | Collier Bridge | 5/07-12/20 | Quarterly to Monthly | 94 | 2007-2014: TKN, Enterococcus 2015-2020: General Parameters, Field Parameters, Nutrients, Micro Parameters |
| | E. Winterberry Bridge | 1/15-12/20 | Quarterly to Monthly | 52 | General Parameters, Field Parameters, Nutrients, Micro Parameters |
| | HC Center | 5/07-12/20 | Quarterly to Monthly | 99 | 2007-2014: TKN, Enterococcus 2015-2020: General Parameters, Field Parameters, Nutrients, Micro Parameters |
| | Hollyhock | 5/07-12/20 | Quarterly to Monthly | 88 | 2007-2014: TKN, Enterococcus 2015-2020: General Parameters, Field Parameters, Nutrients, Micro Parameters |
| | Hummingbird | 5/07-12/20 | Quarterly to Monthly | 79 | 2007-2014: TKN, Enterococcus 2015-2020: General Parameters, Field Parameters, Nutrients, Micro Parameters |
| | JH Park | 5/07-12/20 | Quarterly to Monthly | 100 | 2007-2014: TKN, Enterococcus 2015-2020: General Parameters, Field Parameters, Nutrients, Micro Parameters |

TABLE 2-3 – CONTINUED

**SUMMARY OF HISTORICAL WATER QUALITY
DATA FOR ISLAND MONITORING SITES**

| COLLECTING AGENCY | STATION I.D. | PERIOD OF RECORD | MONITORING FREQUENCY | NUMBER OF EVENTS | TYPE OF DATA |
|----------------------|-----------------------|------------------|----------------------|------------------|--|
| City of Marco Island | Kendall | 1/15-12/20 | Quarterly to Monthly | 41 | General Parameters, Field Parameters, Nutrients, Micro Parameters |
| | Landmark | 10/19-12/20 | Monthly | 24 | General Parameters, Field Parameters, Nutrients, Micro Parameters |
| | McIlvaine | 5/07-12/20 | Quarterly to Monthly | 73 | 2007-2014: TKN, Enterococcus 2015-2020: General Parameters, Field Parameters, Nutrients, Micro Parameters |
| | Olde Marco | 10/19-12/20 | Monthly | 24 | General Parameters, Field Parameters, Nutrients, Micro Parameters |
| | Perrine | 5/07-2/17 | Quarterly | 51 | 2007-2014: TKN, Enterococcus 2015-2020: General Parameters, Field Parameters, Nutrients, Micro Parameters |
| | Swallow | 10/19-12/20 | Monthly | 22 | General Parameters, Field Parameters, Nutrients, Micro Parameters |
| | W. Winterberry Bridge | 1/15-12/20 | Quarterly | 50 | General Parameters, Field Parameters, Nutrients, Micro Parameters |
| | Windmill | 5/07-12/20 | Quarterly | 100 | 2007-2014: TKN, Enterococcus 2015-2020: General Parameters, Field Parameters, Nutrients, Micro Parameters |



Figure 2-2. Locations of Historical Marco Island Water Quality Monitoring Sites.

ERD evaluated the historical data using a variety of methods. First, annual geometric mean values were calculated for each parameter and monitoring site for use in evaluating water quality trends. Trend analyses were conducted for total nitrogen, total phosphorus, chlorophyll-a, and Secchi disk depth at each monitoring site to evaluate water quality stability over the 6-year period from 2015-2020. In addition, graphics were generated which superimpose annual geometric mean values for measured parameters on the site map of water quality monitoring stations (provided in Figure 2-2) to provide an overview of spatial distributions for water quality parameters.

2.2.1.3 Data Summary

A summary of annual geometric mean values from 2015-2020 for each monitoring site included in the historical water quality program is given in Appendix A-2, and overall mean values for historical Marco Island monitoring sites from 2015-2020 are given on Table 2-4. The values summarized in this table reflect the arithmetic average of the annual geometric mean values for each site and parameter, summarized in Appendix A-2. Long-term values which exceed the NNC for nitrogen, phosphorus, and chlorophyll-a are highlighted in **yellow**.

Overall, measured pH values are relatively similar between the monitoring sites and reflect alkaline conditions typical of saltwater waterbodies. Each of the sites exhibited similar levels of dissolved oxygen and oxygen saturation. Salinity values were also relatively similar, although sites closer to tidal waters appear to have higher salinity values.

Measured concentrations of NO_x (nitrite + nitrate) are extremely low in value and likely limit algal production within the waterways. The vast majority of nitrogen consists of TKN which represents approximately 95% or more of the total nitrogen present. Concentrations of total phosphorus appear to be average to somewhat elevated in value for marine systems, with low to slightly elevated levels of chlorophyll-a.

2.2.1.4 Total Nitrogen

A graphical summary of mean annual total nitrogen concentrations in Marco Island waterways from 2015-2020 is given on Figure 2-3. Drainage sub-basin delineations are also provided on Figure 2-3 which are discussed in more detail in Section 3. These values are calculated by taking the arithmetic average of the annual geometric mean concentrations for total nitrogen at each site. Mean total nitrogen concentrations exhibit a relatively high degree of variability, ranging from 411-697 µg/l. None of the Marco Island monitoring sites met the Numeric Nutrient Criteria (NNC) of 300 µg/l established in Chapter 62-302.532 FAC.

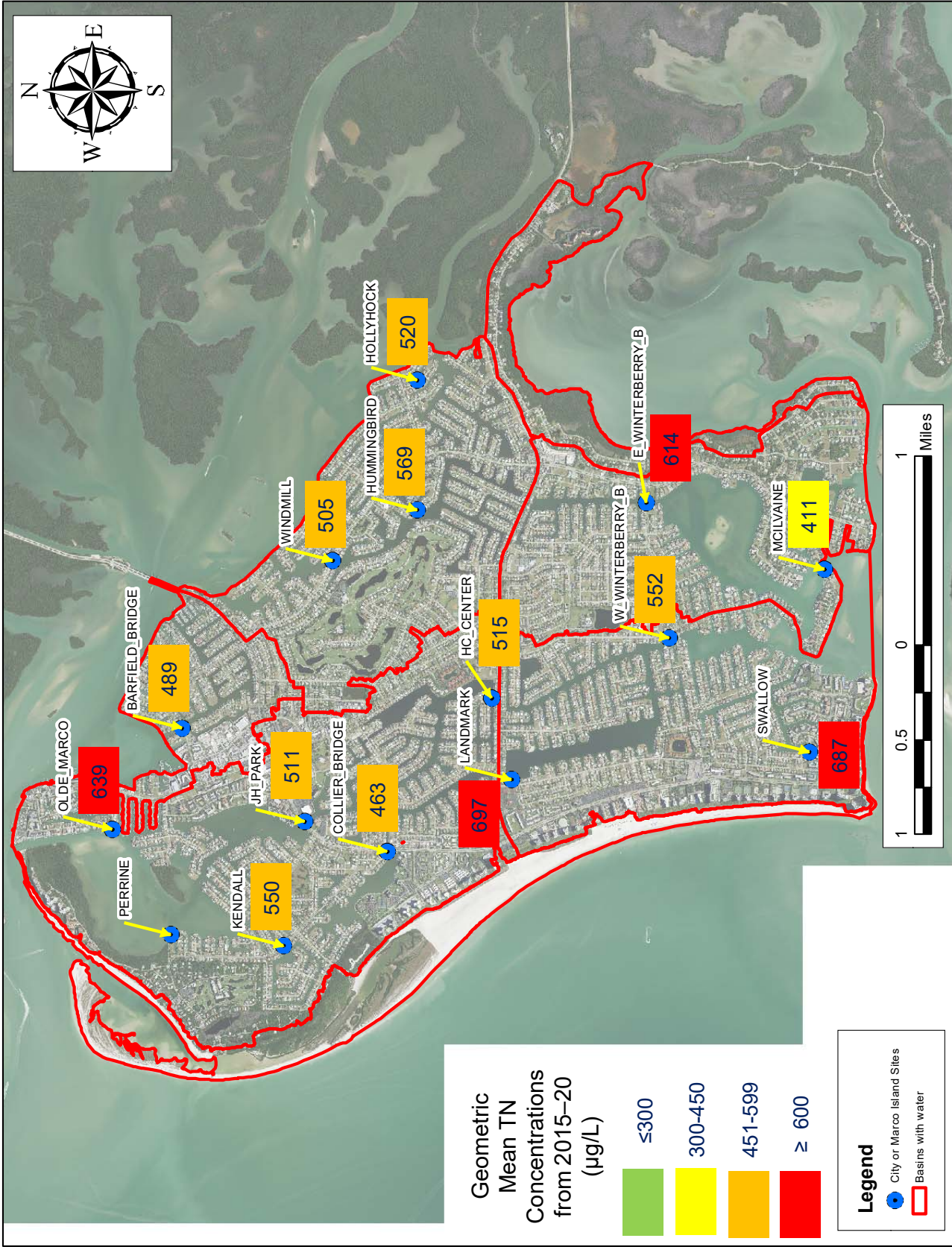



Figure 2-3. Mean Annual Total Nitrogen Concentrations in Marco Island Waterways from 2015-2020.

TABLE 2-4
OVERALL MEAN VALUES FOR HISTORICAL
MARCO ISLAND MONITORING SITES FROM 2015-2020

| MONITORING SITE | PARAMETER | | | | | | | | | | | | | |
|----------------------|-----------|------------------|---------------------|-----------------------------|------------------------|----------------|------------------------|------------|-----------------------|-------------------------|----------------------|-----------------|-----------------------|--------------------------|
| | pH (s.u.) | Temperature (°C) | Diss. Oxygen (mg/l) | Diss. Oxygen (% saturation) | Conductivity (µmho/cm) | Salinity (ppt) | NO _x (µg/l) | TKN (µg/l) | Total Nitrogen (µg/l) | Total Phosphorus (µg/l) | Chlorophyll-a (µg/l) | Turbidity (NTU) | Secchi Disk Depth (m) | Enterococci (cfu/100 ml) |
| Barfield Bridge | 7.86 | 26.18 | 6.1 | 91 | 50,940 | 33.4 | 21 | 468 | 489 | 41 | 4.1 | 4.7 | 1.60 | 30 |
| Collier Bridge | 7.83 | 27.05 | 5.4 | 82 | 48,759 | 31.7 | 20 | 443 | 463 | 42 | 3.1 | 2.2 | 1.71 | 31 |
| E Winterberry Bridge | 7.91 | 26.53 | 5.9 | 89 | 51,466 | 33.8 | 15 | 614 | 629 | 40 | 5.0 | 2.8 | 1.52 | 24 |
| HC Center | 7.83 | 26.79 | 5.9 | 88 | 49,439 | 32.3 | 17 | 498 | 515 | 35 | 4.1 | 1.4 | 1.66 | 19 |
| Hollyhock | 7.77 | 26.38 | 5.2 | 78 | 50,566 | 33.1 | 21 | 500 | 520 | 43 | 5.2 | 2.7 | 1.22 | 22 |
| Hummingbird | 7.83 | 27.07 | 5.7 | 86 | 49,625 | 32.4 | 15 | 554 | 569 | 46 | 5.5 | 1.9 | 1.33 | 34 |
| JH Park | 7.82 | 26.52 | 5.7 | 85 | 50,115 | 32.8 | 19 | 492 | 511 | 38 | 4.1 | 3.1 | 1.59 | 31 |
| Kendall | 7.81 | 26.64 | 5.5 | 82 | 50,122 | 32.8 | 22 | 528 | 550 | 46 | 3.9 | 4.2 | 1.33 | 28 |
| Landmark | 7.85 | 26.66 | 5.5 | 83 | 50,735 | 33.2 | 13 | 684 | 697 | 74 | 6.0 | 1.5 | 1.78 | 32 |
| McIlvaine | 8.02 | 24.76 | 6.0 | 87 | 51,910 | 34.1 | 15 | 396 | 411 | 43 | 3.3 | 1.3 | 1.45 | 20 |
| Olde Marco | 7.92 | 25.71 | 5.5 | 81 | 51,286 | 33.6 | 12 | 627 | 639 | 44 | 2.9 | 3.6 | 1.36 | 133 |
| Swallow | 7.91 | 26.56 | 5.1 | 76 | 48,693 | 31.7 | 31 | 657 | 687 | 75 | 5.8 | 3.4 | 1.34 | 261 |
| W Winterberry Bridge | 7.93 | 26.26 | 6.2 | 92 | 51,542 | 33.8 | 14 | 538 | 552 | 38 | 4.2 | 2.5 | 1.73 | 19 |
| Windmill | 7.83 | 26.40 | 5.8 | 87 | 50,044 | 32.7 | 14 | 491 | 505 | 50 | 5.2 | 3.2 | 1.46 | 36 |

SOURCE: Appendix A-2 (data source for annual values)

 values which exceed applicable NNC

For comparison purposes, “stoplight” colors are assigned to the mean annual nitrogen concentrations with values less than 300 µg/l highlighted in **green**, values from 300-450 µg/l highlighted in **yellow**, values ranging from 451-599 µg/l by **orange**, and values exceeding 600 µg/l in **red**. Two of the highest long-term nitrogen concentrations have occurred at the sites designated as Landmark and Swallow. The Landmark site is on the end of a wide dead-end canal which is characterized by a deep water column and frequent anoxic conditions below a depth of approximately 5-6 m, based on the field monitoring program conducted by ERD. This site receives little, if any, flushing during tidal events. The Swallow monitoring site is also located in a dead-end canal in an area which also appears to be poorly flushed. Elevated levels of total nitrogen were also observed at the E. Winterberry Bridge site which reflects an outlet discharge from Roberts Bay. Although this site has a more direct tidal influence than the Landmark and Swallow sites, water quality at this site can be heavily impacted by sediment disturbance in Roberts Bay (which is relatively shallow in most areas) during windy conditions. In addition, the underside of the E. Winterberry Bridge is home to a large bat colony which may also have water quality impacts.

The last area with long-term annual nitrogen concentrations exceeding 600 µg/l is the Olde Marco site. This site is located adjacent to a shallow navigational channel which is used extensively by boaters since Collier Bay is too shallow for most boats to cross directly. This site is also impacted by sediment disturbance in Collier Bay during windy events, and this phenomenon was visually observed by ERD field personnel on multiple occasions.

Most of the sites with annual nitrogen concentrations less than 500 µg/l are located in areas in relatively close proximity to off-shore waters, although the Jolly Bridge site is located in upstream portions of the respective drainage basin. The remaining sites highlighted in **orange**, with only a few exceptions, appear to be located in mid-portions of waterways in areas with moderate flushing potential.

2.2.1.5 Total Phosphorus

A graphical summary of mean annual total phosphorus concentrations in Marco Island waterways from 2015-2020 is given on Figure 2-4. The NNC criterion for total phosphorus in Marco Island waterways is 46 µg/l, and most of the monitoring sites met this criterion. Long-term total phosphorus concentrations less than 46 µg/l were observed at the JH Park, HC Center, and W. Winterberry Bridge monitoring sites, although each of these appears to be located in middle or upstream portions of the respective watershed areas. The most elevated long-term total phosphorus concentrations in Marco Island waterways occur at the Landmark and Swallow monitoring sites, each of which are located in upstream portions of the respective canal systems, and each of these sites also exhibited highly elevated values for total nitrogen. The next highest long-term total phosphorus concentration occurs at the Windmill monitoring site at a location in middle portions of the respective drainage basin.

2.2.1.6 Chlorophyll-a

A graphical summary of mean annual chlorophyll-a concentrations in Marco Island waterways from 2015-2020 is given on Figure 2-5. The NNC criterion for chlorophyll-a in Marco Island waterways is 4.9 µg/l, and sites which meet this criterion are illustrated in **green**, while sites which exceed this criterion are illustrated in **yellow**. Of the 14 monitoring sites indicated on Figure 2-5, 8 sites (located primarily in central portions of the island) met the current NNC criterion for chlorophyll-a from 2015-2020. Exceedances of the NNC criterion for chlorophyll-a occur at the Landmark and Swallow monitoring sites, which also had exceedances for total phosphorus and total nitrogen along with the 3 monitoring sites which are hydrologically connected to E. Marco Bay. A slight exceedance of the NNC criterion for chlorophyll-a is present at the E. Winterberry Bridge site which also exhibited elevated values for total nitrogen.

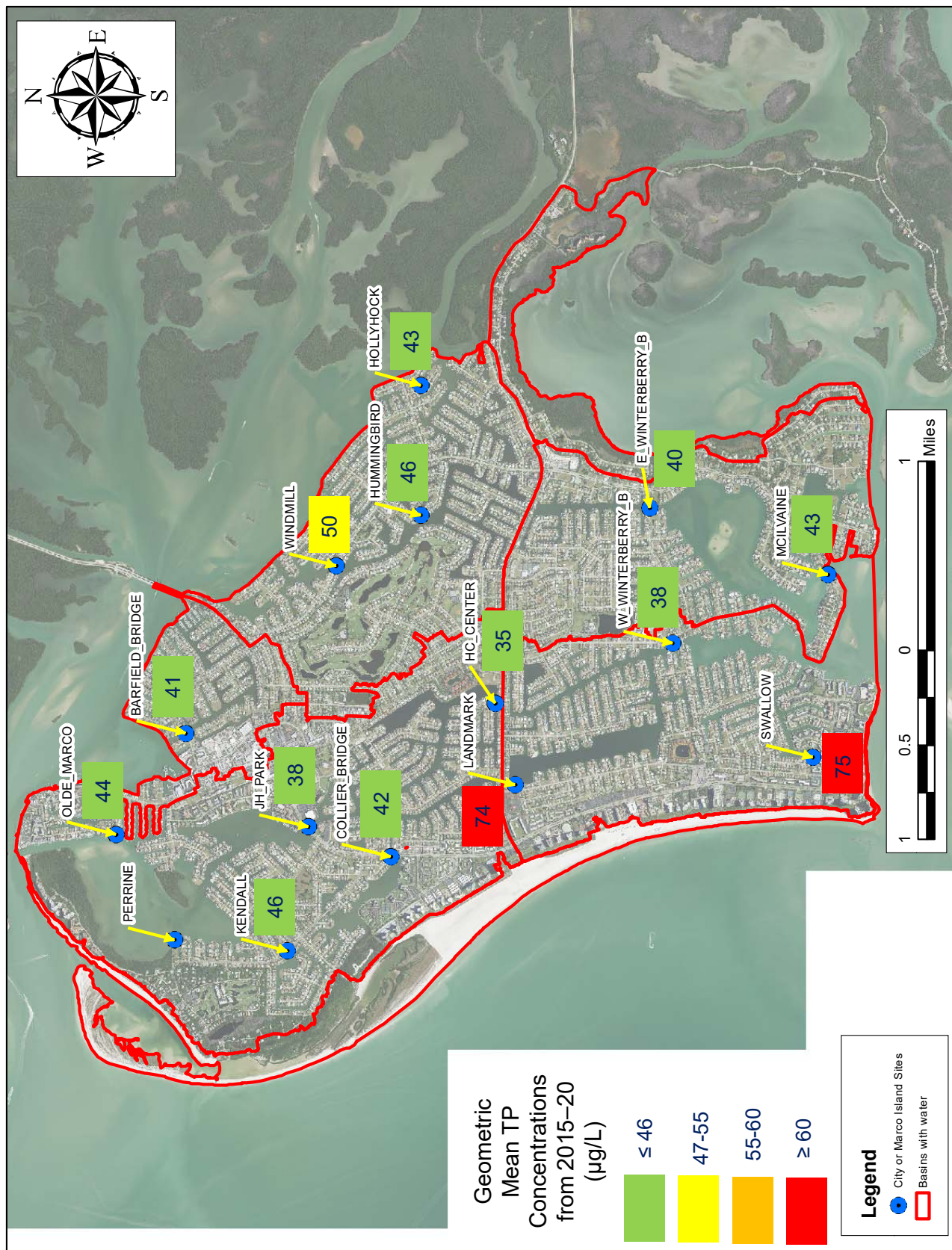

Figure 2-4. Mean Annual Total Phosphorus Concentrations in Marco Island Waterways from 2015-2020.

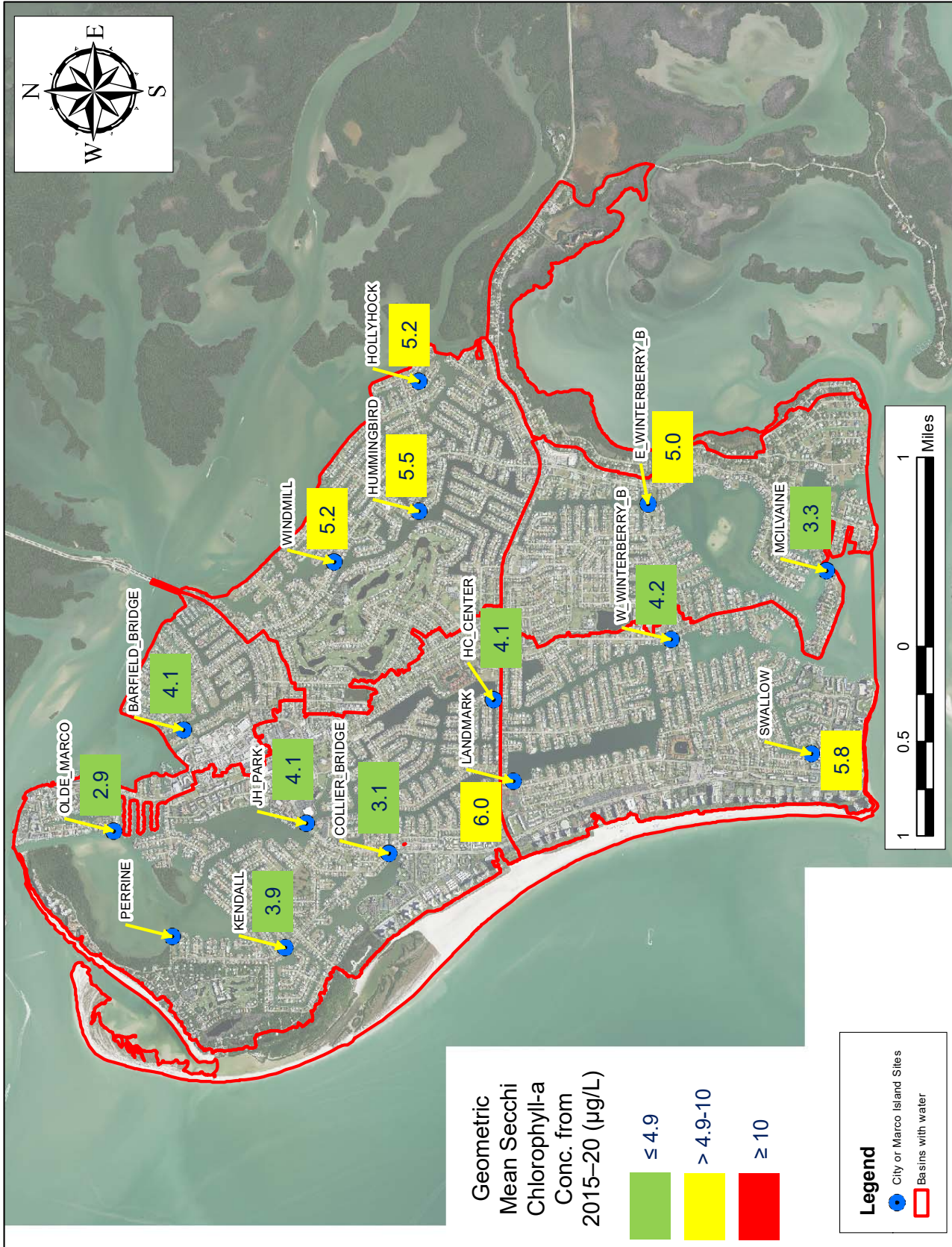

Figure 2-5. Mean Annual Chlorophyll-a Concentrations in Marco Island Waterways from 2015-2020.

2.2.1.7 Secchi Disk Depth

A graphical summary of mean annual Secchi disk depths in Marco Island waterways from 2015-2020 is given on Figure 2-6. There is no NNC criterion for Secchi disk depth, so the mean annual values are divided into measurements less than 1.5 m, values from 1.5-2 m, and values greater than 2 m, which generally reflect good water clarity by most observers. Overall, Secchi disk depths appear to be relatively similar between the individual monitoring sites, ranging from 1.22 m at the Hollyhock monitoring site to 1.78 m at the Landmark monitoring site. It is interesting to note that the Landmark site exhibited the highest measured Secchi disk depth (best water clarity) while also having some of the highest values for total nitrogen and total phosphorus. The highest measured Secchi disk depths appear to occur in interior portions of the island, with poorer water quality observed in areas adjacent to open water.

2.2.1.8 Enterococci

A graphical comparison of mean annual Enterococci counts in Marco Island waterways from 2015-2020 is given on Figure 2-7. The State of Florida Class III criterion for Enterococci in marine waters is 35 colony forming units per 100 ml (cfu/100 ml), and values less than this standard are highlighted in **green**. Values which exceed the standard but are less than 100 cfu/100 ml are highlighted in **yellow**, while values exceeding 100 cfu/100 ml are highlighted in **red**. Eleven of the 14 monitoring sites shown on Figure 2-7 easily meet the long-term Enterococci criterion, indicating no significant sewage impacts at these sites. The Windmill site has an annual mean Enterococci count of 36 cfu/100 ml from 2015-2020 and only slightly exceeds the 35 cfu/100 ml criterion.

However, substantial exceedances of the 35 cfu/100 ml criterion have occurred at the Olde Marco and Swallow monitoring sites. Since Enterococci are more specific to impacts from human activities than other microbial indicators, the elevated values observed at the Olde Marco and Swallow monitoring sites indicate a likely sewage contamination issue at these locations and should be further evaluated by the City. The Olde Marco area historically used septic tanks for sewage disposal but has been converted to a central sewer system.

2.2.1.9 Trend Analyses

Temporal plots of concentrations of total nitrogen, total phosphorus, chlorophyll-a, and Secchi disk depth were developed by ERD for each of the 14 current water quality monitoring sites based upon the historical data summarized in Appendix A-1. Individual measurements of each monitored parameter are indicated in **red** on the plots, and yearly geometric mean concentrations of the evaluated parameters are illustrated as **black dots and lines**. The average annual values are used to generate a regression trend line for nitrogen, phosphorus, chlorophyll-a, and Secchi disk depth to assist in identifying significant water quality trends. The calculated probability value (p-value) for the regression model is also provided which indicates the level of significance associated with each regression model. A model or relationship which is significant at a 95% confidence level would be associated with a p-value of 0.05. Temporal plots and regression analyses for each active monitoring site are provided in Appendix A-3.

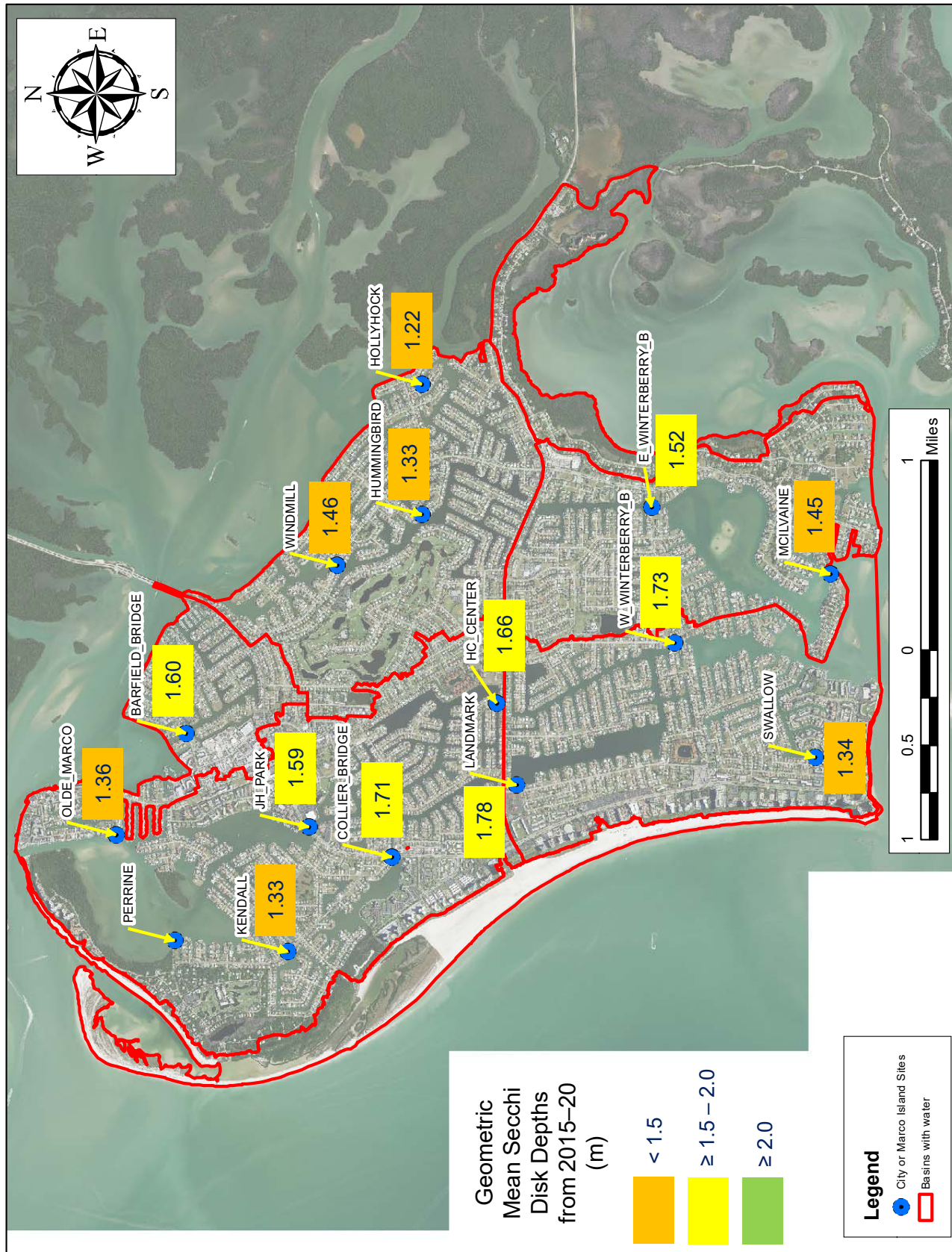

Figure 2-6. Mean Annual Secchi Disk Depths in Marco Island Waterways from 2015-2020.

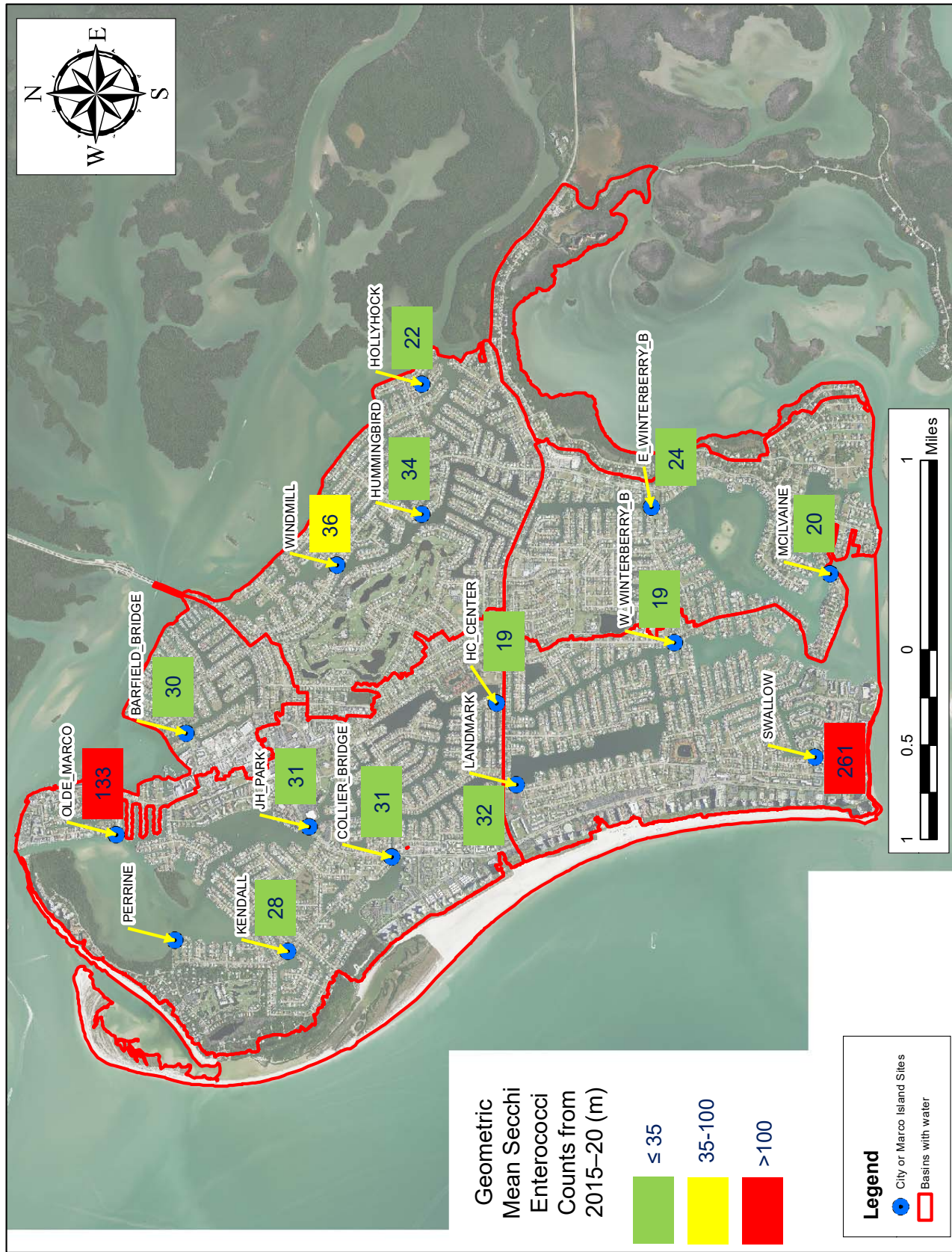

Figure 2-7. Mean Annual Enterococci Counts in Marco Island Waterways from 2015-2020.

A summary of trendline slopes and level of significance for Marco Island monitoring sites from 2015-2020 is given on Table 2-5. Information on the trendline slope is provided for nitrogen, phosphorus, chlorophyll-a, and Secchi disk depth which reflects the change in concentration or value on an annual basis. Positive values indicate increases, while negative values indicate decreases for respective parameters. Information is also provided on the level of significance for the trendlines associated with each variable.

TABLE 2-5
TRENDLINE SLOPES AND LEVEL OF SIGNIFICANCE
FOR MARCO ISLAND MONITORING SITES FROM 2015-2020

| MONITORING SITE | TRENDLINE SLOPE (Concentration or Value/Year) | | | | SLOPE SIGNIFICANCE PROBABILITY (p-value) | | | |
|----------------------|--|---------|--------|--------|--|---------|--------|--------|
| | Total N | Total P | Chyl-a | Secchi | Total N | Total P | Chyl-a | Secchi |
| Barfield Bridge | 53.5 | 6.1 | 0.4 | -0.07 | 0.0034 | 0.0168 | 0.0320 | 0.0029 |
| Collier Bridge | 35.8 | 4.6 | -0.03 | 0.01 | 0.0055 | 0.0311 | 0.4058 | 0.4011 |
| E Winterberry Bridge | 15.3 | 5.6 | -0.2 | 0.004 | 0.7873 | 0.3753 | 0.5984 | 0.4102 |
| HC Center | 39 | 5.8 | 0.5 | -0.09 | 0.4007 | 0.1223 | 0.2996 | 0.3148 |
| Hollyhock | 72.5 | 6.6 | 0.6 | 0.096 | 0.2194 | 0.3173 | 0.4627 | 0.0586 |
| Hummingbird | 71.0 | 6.3 | 0.4 | 0.03 | 0.2692 | 0.3501 | 0.5248 | 0.3332 |
| JH Park | 52.7 | 6.15 | 0.3 | 0.04 | 0.3795 | 0.1605 | 0.4207 | 0.6507 |
| Kendall | 43.9 | 5.9 | 0.2 | -0.20 | 0.1212 | 0.3288 | 0.6356 | 0.1167 |
| McIlvaine | 49.5 | 4.20 | -0.07 | 0.18 | 0.0423 | 0.2689 | 0.7506 | 0.1097 |
| W Winterberry Bridge | 66.0 | -1.44 | -0.20 | -0.05 | 0.1829 | 0.7185 | 0.2705 | 0.3816 |
| Windmill | 47.0 | 6.46 | 0.4 | -0.06 | 0.4279 | 0.2763 | 0.2137 | 0.1371 |



Significant decrease @ 0.05 level

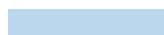

Significant decrease @ 0.01 level



Significant increase @ 0.05 level



Significant increase @ 0.01 level

Increases have been observed in total nitrogen concentrations at the Barfield Bridge and Collier Bridge from 2015-2020, and this relationship is significant at a 0.01 level (99% confidence). The slope indicates an increase of approximately 54 mg/l-yr for total nitrogen at the Barfield Bridge site and 36 mg/l increase per year at the Collier Bridge site. A significant increase in total nitrogen was also observed at the McIlvaine monitoring site although at a 0.05 level of significance (95% confidence).

A statistically significant increase was also observed for total phosphorus concentrations (0.05 level) at the Collier Bridge site and for chlorophyll-a (0.05 level) at the Barfield Bridge site. A significant decrease in Secchi disk depth or water clarity was also observed at the Barfield Bridge site (99% confidence).

Other than the highlighted squares on Table 2-5, none of the sites appear to exhibit a trend of either increasing or decreasing concentrations for the evaluated parameters over the past 6-year period. However, a minimum data period of approximately 10 years is usually considered to be the minimum amount of data necessary to detect truly significant water quality trends, and since the available period of data is only 6 years, the parameters exhibiting statistically significant changes over time may vary as more data become available.

2.2.1.10 Statistical Comparisons of Sites

Statistical comparisons of historical water quality data for Marco Island monitoring sites were generated in the form of box and whisker plots. The bottom of the box portion of each plot represents the lower quartile, with 25% of the data points falling below this value. The upper line of the box represents the 75% upper quartile, with 25% of the data falling above this value. The [blue horizontal line](#) within the box represents the median value, with 50% of the data falling both above and below this value. The vertical lines, also known as “whiskers”, represent the 10 and 90 percentiles for the data sets. Individual values which fall outside of the 10-90 percentile range are indicated as [red dots](#). Box and whisker plots for all measured parameters at the Marco Island sites from 2015-2020 are provided in Appendix A-4, and a discussion of plots for total nitrogen, total phosphorus, chlorophyll-a, and Secchi disk depth is provided in this section. The applicable NNC values for total nitrogen, total phosphorus, and chlorophyll-a are indicated by a [green line](#) for reference purposes.

A statistical comparison of concentrations of total nitrogen and total phosphorus measured in Marco Island waterways from 2015-2020 is given on Figure 2-8. Measured concentrations of total nitrogen exhibited a relatively high degree of variability in Marco Island waterways from 2015-2020, with measured values ranging from approximately 100 µg/l to more than 2,000 µg/l. It is interesting to note that the lowest degree of variability in measured total nitrogen concentrations appear to occur at sites in upstream portions of each respective drainage system at sites such as Collier Bridge, HC Center, Landmark, and Swallow, compared with values measured at the remaining sites. The relatively stable nitrogen concentrations observed at these sites suggest a lack of mixing and flushing at these sites. Overall, the vast majority of measured total nitrogen concentrations from 2015-2020 exceeded the water quality criterion of 300 µg/l for total nitrogen.

Measured concentrations of total phosphorus also exhibited a relatively high degree of variability in measured values, with concentrations ranging from less than 10 µg/l to more than 300 µg/l. In contrast to the trends observed for total nitrogen, approximately half of the measured total phosphorus values appear to be less than the applicable NNC criterion of 46 µg/l. A slightly lower degree of variability in measured phosphorus concentrations is also apparent at many of the sites exhibiting low variability in nitrogen concentrations, although the trends are not as significant as those observed for total nitrogen.

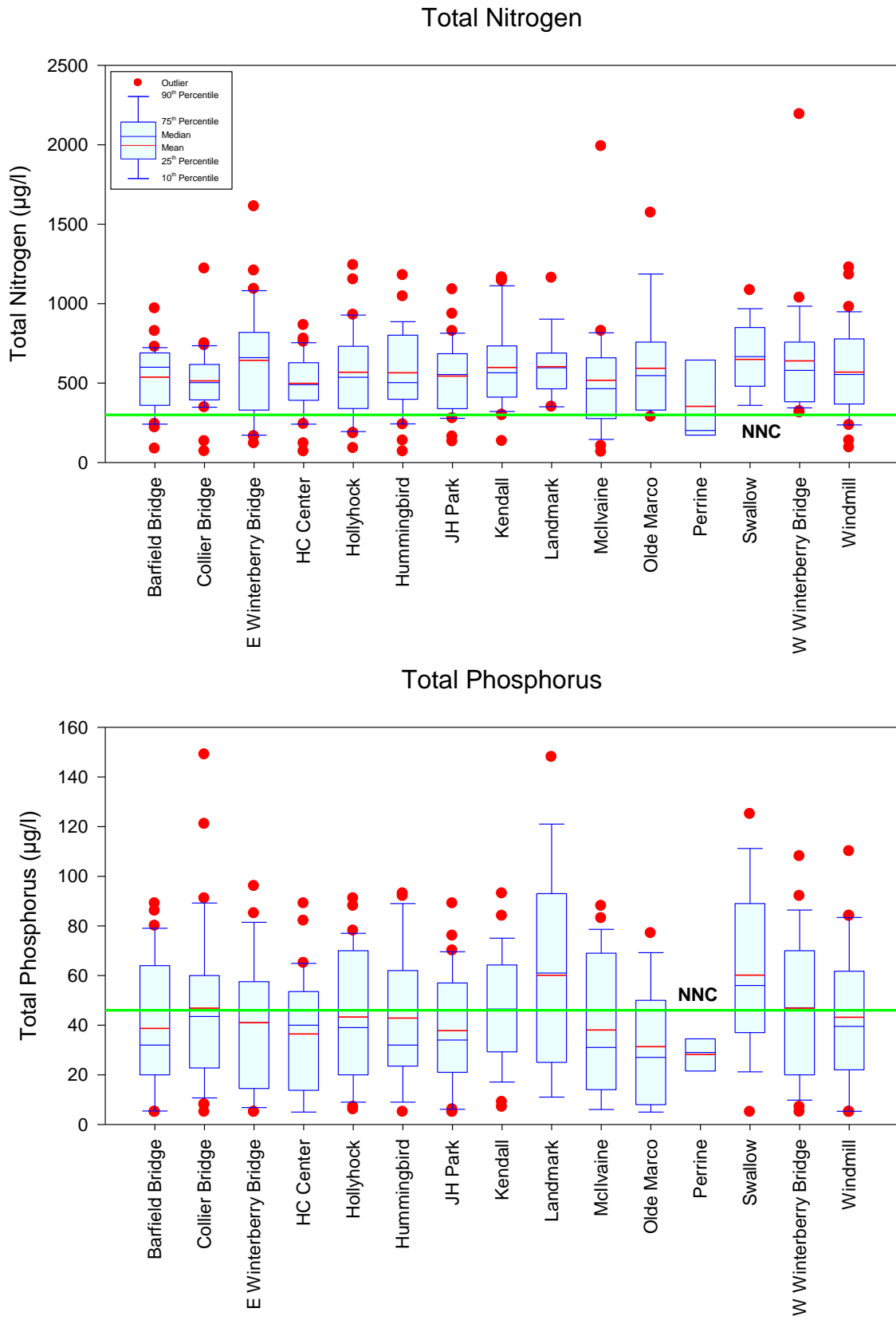

Figure 2-8. Statistical Comparison of Concentrations of Total Nitrogen and Total Phosphorus Measured in Marco Island Waterways from 2015-2020.

A statistical comparison of concentrations of chlorophyll-a and measured Secchi disk depths in Marco Island waterways from 2015-2020 is given on Figure 2-9. Measured chlorophyll-a values have ranged from 1-23 $\mu\text{g/l}$, although a value exceeding 170 $\mu\text{g/l}$ was observed on 1 occasion at the Swallow monitoring site. Similar to the trend observed for total phosphorus, slightly more than half of the measured chlorophyll-a values have met the NNC criterion of 4.9 $\mu\text{g/l}$ at the Marco Island sites. Also, similar to the trends observed for total nitrogen and total phosphorus, a lower degree of variability in measured chlorophyll-a concentrations was observed at the Collier Bridge, Kendall, and Landmark monitoring sites, each of which is located in upstream portions of the respective drainage basin. A relatively low degree of variability was observed at the McIlvaine and Olde Marco monitoring sites, each of which is located in close proximity to open tidal waters.

A relatively high degree of variability has also been observed in measured Secchi disk depths at the various monitoring sites, with measured values ranging from 0.6-3 m. Overall, measured Secchi disk depths reflect water clarity ranging from poor to good, with fair water quality on an overall basis.

A statistical comparison of measured values for Enterococcus in Marco Island waterways from 2015-2020 is given on Figure 2-10, with a logarithmic scale used for Enterococcus concentrations. Measured Enterococcus concentrations have been extremely variable in value, ranging from near zero to more than 10,000 cfu/100 ml. A majority of the measured values appear to be less than the applicable water quality criterion of 35 cfu/100 ml, although exceedances well in excess of 1,000 and even 10,000 have been observed at virtually all sites on multiple occasions.

2.2.1.11 Summary

Overall, water quality characteristics in Marco Island waterways have been relatively consistent at most sites from 2015-2020, although statistically significant increases in values have been observed for total nitrogen, chlorophyll-a, and Secchi disk depth at the Barfield Bridge site; for total nitrogen and total phosphorus at the Collier Bridge site; and for total nitrogen at the McIlvaine site. Overall mean total nitrogen concentrations in Marco Island waterways from 2015-2020 have been moderate to elevated in value, with virtually all measurements exceeding the water quality criterion of 300 $\mu\text{g/l}$.

Annual mean total phosphorus concentrations in Marco Island waterways have been low to moderate in value, with concentrations at 11 of the 14 monitoring sites less than or equal to the applicable criterion of 46 $\mu\text{g/l}$ for total phosphorus. Exceedances of the criterion for both total nitrogen and total phosphorus have been consistently observed at the Landmark and Swallow monitoring sites, each of which is located in upstream portions of a relatively stagnant canal system.

Water clarity at the Marco Island monitoring sites has been poor to good, with overall fair water quality characteristics on a long-term basis. Enterococci counts at a majority of the monitoring sites are well below the criterion for this parameter of 35 cfu/100 ml. However, substantial exceedances of the Enterococci standard have been observed at the Olde Marco and Swallow monitoring sites, suggesting possible sewage impacts at these sites. The Olde Marco district has a privately owned and operated collection system. Sewage from Old Marco Lane North is collected by North Marco Utilities and pumped to the City wastewater facility for treatment.

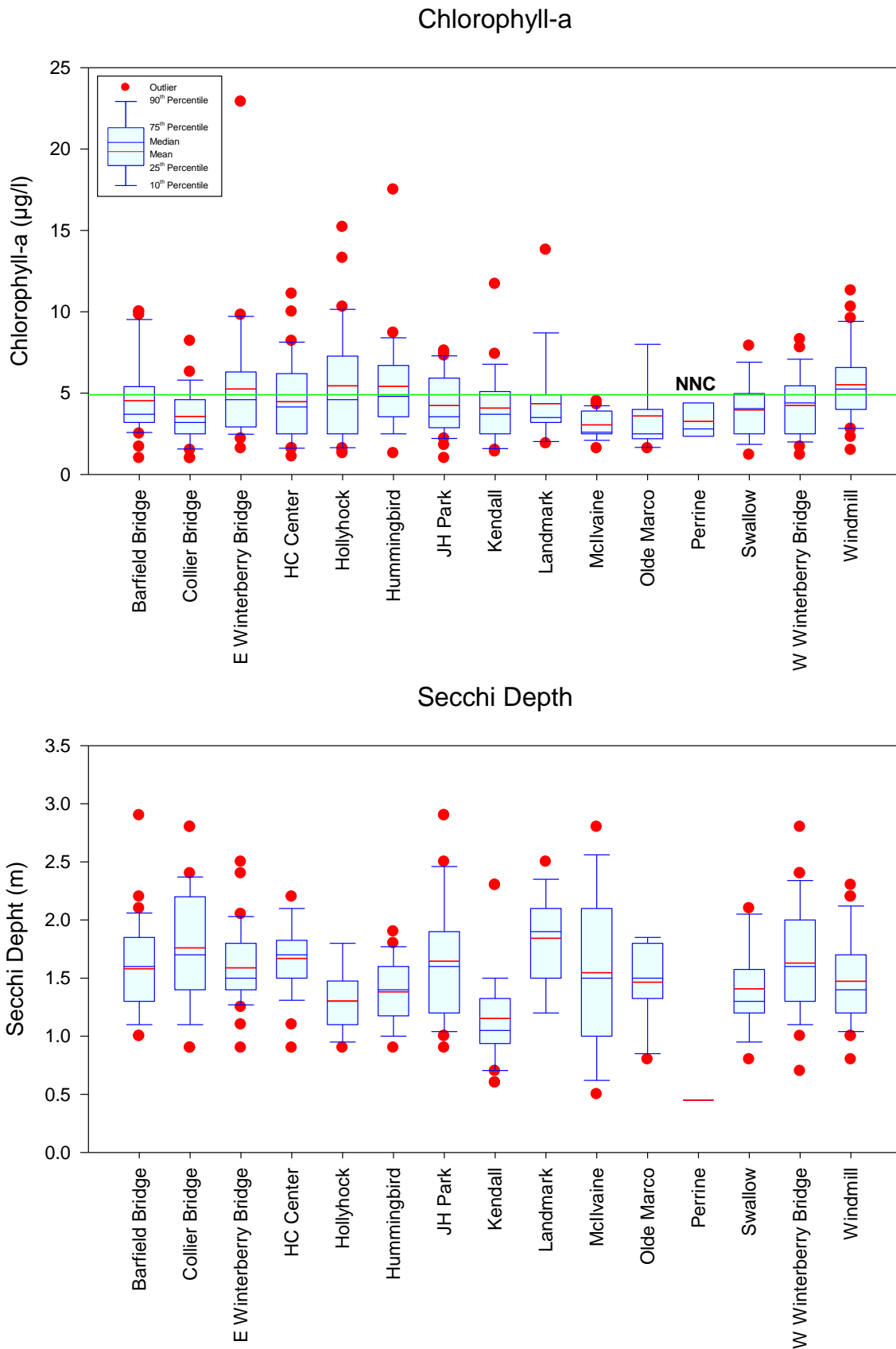

Figure 2-9. Statistical Comparison of Concentrations of Chlorophyll-a and Secchi Disk Depths Measured in Marco Island Waterways from 2015-2020.

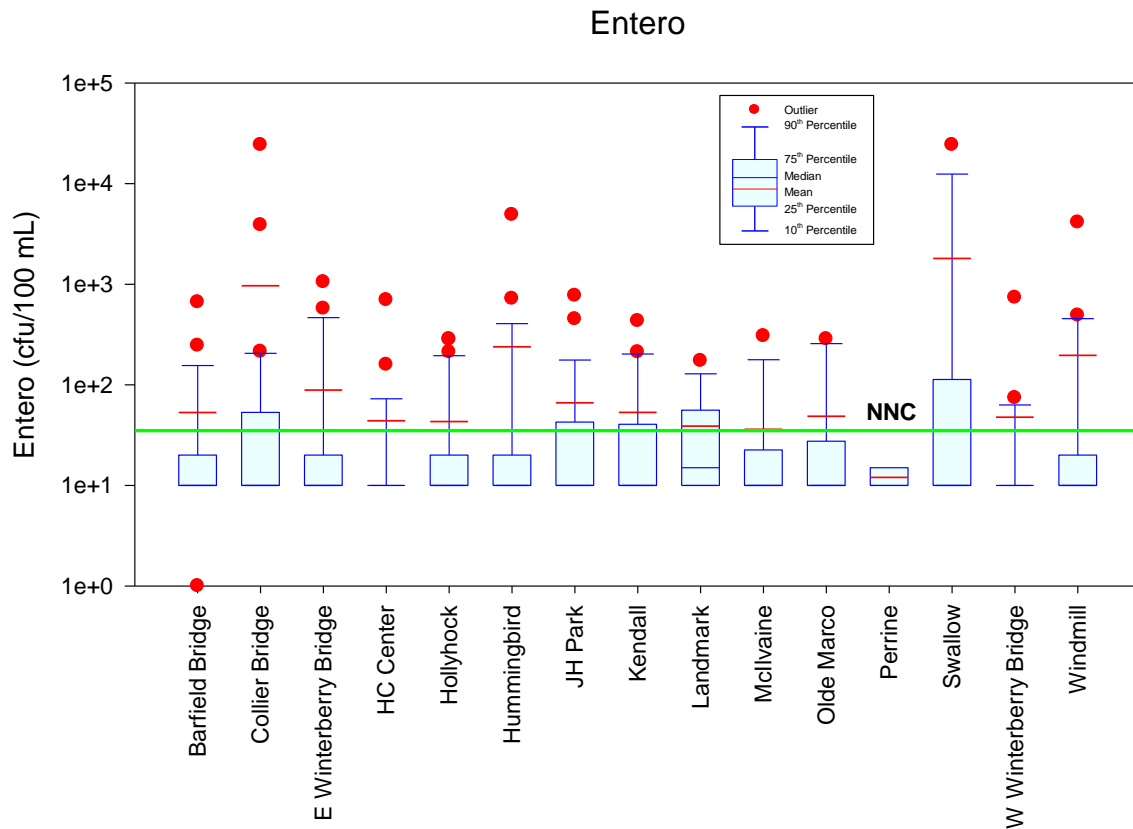

Figure 2-10. Statistical Comparison of Concentrations of Enterococcus Counts in Marco Island Waterways from 2015-2020.

2.2.2 Off-Island Waterways

2.2.2.1 Data Availability

In addition to the historical monitoring conducted by the City of Marco Island (discussed in the previous section), a large amount of historical monitoring data has been collected by other agencies, such as Collier County, the South Florida Water Management District (SFWMD), FDEP, and the Florida Department of Health (FDOH). An overview of historical monitoring sites used by other agencies is given on Figure 2-11. The vast majority of the monitoring efforts have been conducted in off-island waters, although multiple monitoring sites have also been included within the Marco Island waterways.

An expanded view of off-island monitoring sites north of Marco Island is given on Figure 2-12. A large number of monitoring sites have been included in this area, although few of these historical sites have current water quality data.

A summary of historical water quality data for off-island monitoring sites collected by other agencies is given in Table 2-6. Monitoring data have been collected by SFWMD, LakeWatch, FDOH, and FDEP.

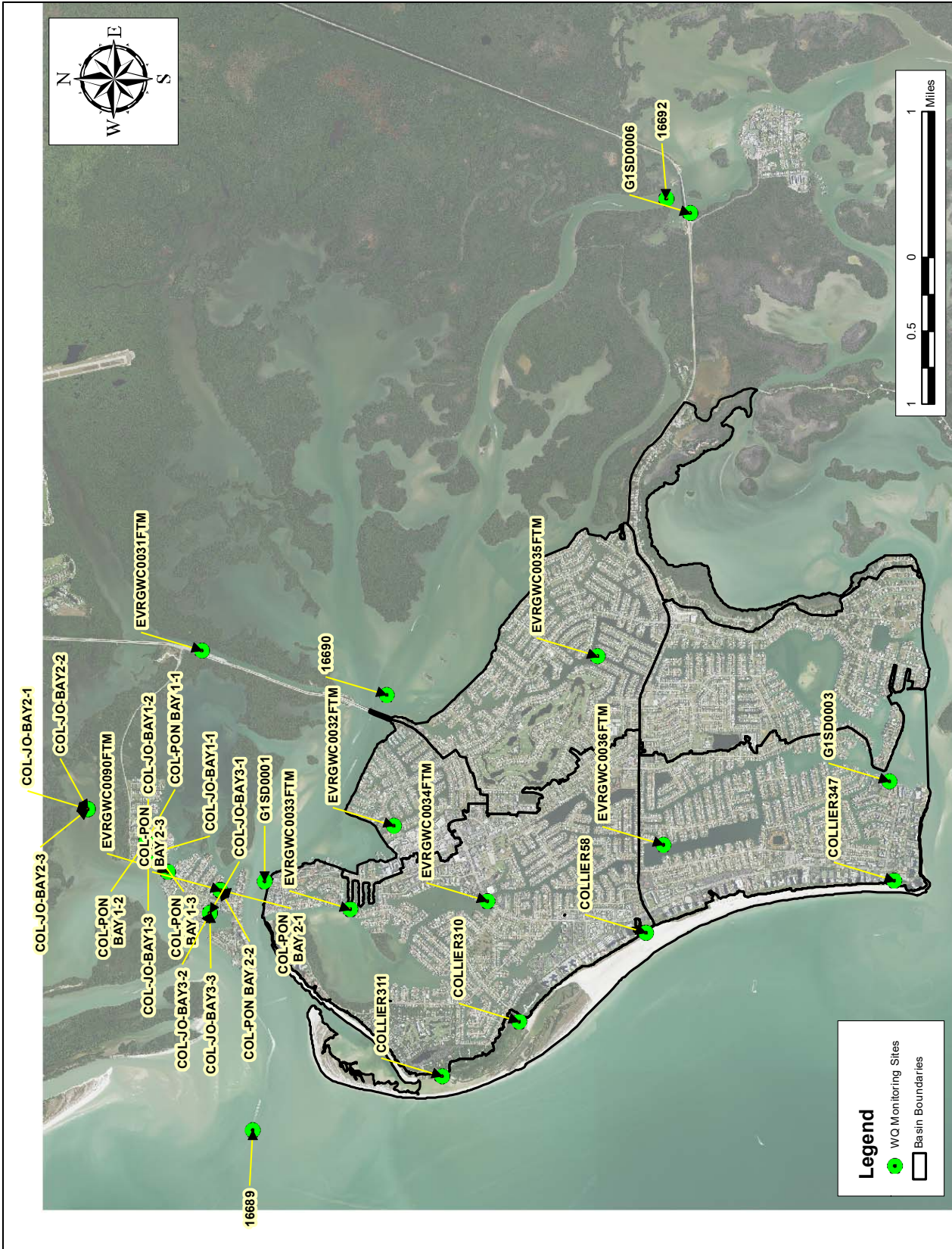

Figure 2-11. Overview of Historical Water Quality Monitoring Sites by Other Agencies.



Figure 2-12. Expanded View of Off-Island Monitoring Sites North of Marco Island Near Isles of Capri.

TABLE 2-6

**SUMMARY OF HISTORICAL WATER QUALITY
DATA FOR OFF-ISLAND MONITORING SITES**

| COLLECTING AGENCY | STATION I.D. | PERIOD OF RECORD | MONITORING FREQUENCY | NUMBER OF EVENTS | TYPE OF DATA |
|---|--------------------------------|------------------|----------------------|------------------|--|
| South Florida Water Management District (SFWMD) | 16689 Gulf of Mexico | 1/15-9/20 | Quarterly to monthly | 27 | Field Parameters, General Parameters, Nutrients, Chlorophyll-a |
| | 16690 E. Marco Bay | 1/15-9/20 | Quarterly to monthly | 29 | Field Parameters, General Parameters, Nutrients, Chlorophyll-a |
| | 16692 CR 92 at Goodland Bay | 1/15-9/20 | Quarterly to monthly | 29 | Field Parameters, General Parameters, Nutrients, Chlorophyll-a |
| LakeWatch | Col-Jo Bay1-1 | 4/01-12/11 | Quarterly | 43 | Total Nitrogen, Secchi Disk Depth |
| | Col-Jo Bay1-2 | 4/01-12/11 | Quarterly | 43 | Total Nitrogen, Secchi Disk Depth |
| | Col-Jo Bay1-3 | 4/01-12/11 | Quarterly | 43 | Total Nitrogen, Secchi Disk Depth |
| | Col-Jo Bay2-1 | 4/01-12/11 | Quarterly | 42 | Total Nitrogen, Secchi Disk Depth |
| | Col-Jo Bay2-2 | 4/01-12/11 | Quarterly | 41 | Total Nitrogen, Secchi Disk Depth |
| | Col-Jo Bay2-3 | 4/01-12/11 | Quarterly | 41 | Total Nitrogen, Secchi Disk Depth |
| | Col-Jo Bay3-1 | 2/04-12/11 | Quarterly | 33 | Total Nitrogen, Secchi Disk Depth |
| | Col-Jo Bay3-2 | 2/04-12/11 | Quarterly | 33 | Total Nitrogen, Secchi Disk Depth |
| | Col-Jo Bay3-3 | 2/04-12/11 | Quarterly | 33 | Total Nitrogen, Secchi Disk Depth |
| | Col-Pon Bay 1-1 | 4/01-9/11 | Quarterly | 42 | Total Nitrogen, Secchi Disk Depth |
| | Col-Pon Bay 1-2 | 4/01-9/11 | Quarterly | 42 | Total Nitrogen, Secchi Disk Depth |
| | Col-Pon Bay 1-3 | 4/01-9/11 | Quarterly | 42 | Total Nitrogen, Secchi Disk Depth |
| | Col-Pon Bay 2-1 | 2/04/12/11 | Quarterly | 33 | Total Nitrogen, Secchi Disk Depth |
| | Col-Pon Bay 2-2 | 2/04/12/11 | Quarterly | 33 | Total Nitrogen, Secchi Disk Depth |
| | Col-Pon Bay 2-3 | 2/04/12/11 | Quarterly | 33 | Total Nitrogen, Secchi Disk Depth |
| Florida Department of Health (FDOH) | Collier 310 | 4/17-12/20 | Weekly | 192 | Enterococcus |
| | Collier 311 | 4/17-12/20 | Weekly | 172 | Enterococcus |
| | Collier 347 | 4/17-12/20 | Weekly | 175 | Enterococcus |
| | Collier 58 | 4/17-12/20 | Weekly | 183 | Enterococcus |

TABLE 2-6 – CONTINUED

**SUMMARY OF HISTORICAL WATER QUALITY
DATA FOR OFF-ISLAND MONITORING SITES**

| COLLECTING AGENCY | STATION I.D. | PERIOD OF RECORD | MONITORING FREQUENCY | NUMBER OF EVENTS | TYPE OF DATA |
|---|-----------------|------------------|----------------------|------------------|---|
| Florida Department of Environmental Protection (FDEP) | EVRGWC 0031 FTM | 1/06-10/10 | Varies | 7 | Field Parameters, General Parameters, Nitrogen, Secchi Disk Depth |
| | EVRGWC 0032 FTM | 1/06-10/06 | Quarterly | 3 | Field Parameters, General Parameters, Nitrogen, Secchi Disk Depth |
| | EVRGWC 0033 FTM | 1/06-10/06 | Quarterly | 3 | Field Parameters, General Parameters, Nitrogen, Secchi Disk Depth |
| | EVRGWC 0034 FTM | 1/06-10/06 | Varies | 2 | Field Parameters, General Parameters, Nitrogen, Secchi Disk Depth |
| | EVRGWC 0035 FTM | 1/06-10/06 | Quarterly | 3 | Field Parameters, General Parameters, Nitrogen, Secchi Disk Depth |
| | EVRGWC 0036 FTM | 1/06-10/06 | Quarterly | 3 | Field Parameters, General Parameters, Nitrogen, Secchi Disk Depth |
| | EVRGWC 0037 FTM | 1/06-10/06 | Quarterly | 3 | Field Parameters, General Parameters, Nitrogen, Secchi Disk Depth |
| | EVRGWC 0090 FTM | 2/10-10/10 | Quarterly | 4 | Field Parameters, General Parameters, Secchi Disk Depth |
| | GIS D0001 | 9/14-9/20 | Quarterly | 24 | Field Parameters, General Parameters, Nutrients |
| | GIS D0003 | 9/14-11/20 | Quarterly | 24 | Field Parameters, General Parameters, Nutrients |
| | GIS D0006 | 9/17-11/20 | Quarterly | 23 | Field Parameters, General Parameters, Nutrients |

The most complete data set for off-island monitoring sites have been conducted by SFWMD. The District has monitored 3 separate sites designated as Site 16689 (located in the Gulf of Mexico along the channel which discharges west from Marco Bay), Site 16690 (located in E. Marco Bay south of the Collier Bridge), and Site 16692 (located north of the CR 92 bridge in Goodland Bay). These sites provide a good overview of ambient water quality in off-shore waterbodies.

The LakeWatch Program conducted a large amount of monitoring at sites located north of Marco Island, as illustrated on Figure 2-12. Monitoring was conducted from 2001-2011 on a quarterly basis, with measurements conducted for total nitrogen and Secchi disk depth. However, due to the age of these data, they are not discussed in this analysis.

FDOH has also conducted a large amount of microbiological monitoring in perimeter portions of the west and southwest sides of the island. The number of samples collected at these sites from 2017-2020 ranges from 172-192 separate samples, all of which were analyzed only for *Enterococcus* bacteria.

FDEP collected a limited number of samples during 2006 and 2010 at the sites designated by the prefix EVRGWC as part of the program to identify impaired waters. Due to the age of these samples, these data are also not discussed in this report.

Additional data were also collected by FDEP at sites designated as GIS D0001 (located on the north end of Marco Island), GIS D0003 (located on the south end of the island), and GIS D0006 (located at the CR 92 bridge at Goodland Bay). Since data collected at this site are relatively current and include a large number of measured parameters, these data are included in the discussion in this analysis.

2.2.2.2 Data Analysis

A complete listing of historical water quality data for each of the off-island monitoring sites summarized in Table 2-6 is given in Appendix A-5. Data collected by SFWMD, FDOH, and FDEP are included for purposes of this evaluation. The period of record for the SFWMD data set is from 2015-2020, with a comparable period of 2014-2020 for the FDEP data. For purposes of this analysis, and to be consistent with analyses conducted for the historical island monitoring sites, only data collected from 2015-2020 are included in this evaluation.

A comparison of annual geometric mean values for water quality data in waterbodies adjacent to Marco Island from 2015-2020 is given on Table 2-7. Annual geometric mean values which exceed the NNC values listed in Table 2-1 are highlighted in **yellow**. Measured values for pH, temperature, and dissolved oxygen at the off-site monitoring locations are similar to values measured within the island waterways and are typical of values commonly observed in estuarine systems. Measured conductivity and salinity values at the off-island sites appear to be slightly greater during some events than observed at the Marco Island sites which would be expected due to the more direct connections to tidal waterbodies for the off-site locations.

Measured concentrations of both ammonia and NO_x are extremely low in value at each of the off-site monitoring locations. Concentrations of NO_x at the off-site monitoring locations appear to be lower in value at almost all sites than NO_x concentrations measured within the Marco Island waterways, suggesting enrichment of NO_x within the waterways and canals compared with off-site waterbodies.

Measured concentrations of total nitrogen in the off-site waterbodies appear to be slightly lower in value than typical concentrations measured in the island waterways, although virtually all of the annual geometric mean values for total nitrogen in off-shore waterbodies exceed the NNC of 300 $\mu\text{g}/\text{l}$. Measured concentrations of total phosphorus in off-site waterbodies appear to be similar to, or perhaps greater than, phosphorus concentrations measured in the island waterways. Approximately one-third (9 of 27 values) of the annual geometric mean values in the off-shore waterbodies exceeded the NNC of 46 $\mu\text{g}/\text{l}$ for total phosphorus over the period from 2015-2020.

TABLE 2-7
ANNUAL GEOMETRIC MEAN VALUES FOR WATER QUALITY
DATA IN WATERBODIES ADJACENT TO MARCO ISLAND FROM 2015-2020

| COLLECTING AGENCY | STATION I.D. | SAMPLE DATE | PARAMETER | | | | | | | | | | | | | | |
|-------------------|--|-------------|-----------|------------------|---------------------|------------------------|----------------|------------------|------------------------|------------|-----------------------|-------------------------|----------------------|-----------------|-----------------------|------------|---|
| | | | pH (s.u.) | Temperature (°C) | Diss. Oxygen (mg/l) | Conductivity (µmho/cm) | Salinity (ppt) | Ammonia N (µg/l) | NO _x (µg/l) | TKN (µg/l) | Total Nitrogen (µg/l) | Total Phosphorus (µg/l) | Chlorophyll-a (µg/l) | Turbidity (NTU) | Secchi Disk Depth (m) | TOC (mg/l) | |
| SFWMD | 16689 (Gulf near Marco Bay Channel) | 2015 | 7.88 | 26.05 | 6.5 | 51,905 | 34.1 | 9 | 6 | - | 285 | 21 | 1.6 | 2.1 | 2.01 | 2.5 | |
| | | 2016 | - | - | - | - | - | - | - | - | - | - | - | - | - | - | - |
| | | 2017 | 7.88 | 25.52 | 6.3 | 48,758 | 31.8 | 7 | 5 | - | 308 | 37 | 3.1 | 4.0 | 1.22 | 2.9 | |
| | | 2018 | 7.94 | 24.33 | 6.3 | 54,224 | 35.0 | 8 | 5 | - | 322 | 31 | 2.7 | 2.7 | 1.77 | 3.1 | |
| | | 2019 | 8.05 | 26.42 | 6.5 | 52,525 | 34.5 | 6 | 5 | - | 307 | 29 | 2.3 | 2.1 | 2.18 | 2.9 | |
| | | 2020 | 7.92 | 23.80 | 6.5 | 52,265 | 34.4 | 8 | 5 | - | 277 | 28 | 1.5 | 1.8 | 2.22 | 2.6 | |
| SFWMD | 16690 (East Marco Bay South of Jolly Bridge) | 2015 | 7.82 | 26.64 | 5.8 | 50,893 | 33.3 | 13 | 9 | - | 393 | 37 | 2.7 | 5.7 | 1.05 | 3.5 | |
| | | 2016 | - | - | - | - | - | - | - | - | - | - | - | - | - | - | |
| | | 2017 | 7.78 | 25.25 | 5.1 | 48,002 | 31.0 | 21 | 6 | - | 424 | 53 | 5.2 | 7.6 | 1.07 | 4.1 | |
| | | 2018 | 7.85 | 24.48 | 5.7 | 52,514 | 34.1 | 25 | 8 | - | 424 | 52 | 2.7 | 5.8 | 1.05 | 4.2 | |
| | | 2019 | 7.92 | 26.67 | 5.7 | 51,721 | 33.9 | 14 | 5 | - | 355 | 34 | 3.1 | 3.7 | 0.98 | 3.5 | |
| | | 2020 | 7.82 | 24.32 | 5.9 | 32,671 | 34.0 | 9 | 5 | - | 360 | 40 | 2.8 | 5.4 | 1.19 | 3.2 | |
| SFWMD | 16692 (San Marco Road Near Goodland) | 2015 | 7.77 | 26.66 | 5.1 | 46,960 | 32.9 | 25 | 18 | - | 493 | 47 | 3.7 | 7.2 | 0.77 | 4.9 | |
| | | 2016 | - | - | - | - | - | - | - | - | - | - | - | - | - | - | |
| | | 2017 | 7.78 | 25.25 | 5.1 | 48,002 | 31.0 | 21 | 6 | - | 424 | 53 | 5.2 | 7.6 | 1.07 | 4.1 | |
| | | 2018 | 7.85 | 24.48 | 5.7 | 52,514 | 34.1 | 25 | 8 | - | 424 | 52 | 2.7 | 5.8 | 1.05 | 4.2 | |
| | | 2019 | 7.87 | 26.53 | 5.1 | 50,825 | 34.6 | 25 | 7 | - | 450 | 52 | 3.5 | 7.2 | 0.81 | 4.7 | |
| | | 2020 | 7.74 | 24.15 | 5.3 | 50,543 | 33.1 | 20 | 6 | - | 435 | 51 | 3.6 | 8.4 | 1.00 | 4.1 | |
| FDEP | G1SD0001 | 2015 | 7.87 | 27.80 | 5.4 | 50,360 | - | - | 23 | 518 | 543 | - | - | - | - | - | |
| | | 2016 | 7.94 | 23.87 | 6.0 | 51,521 | - | - | 13 | - | - | - | - | - | - | - | |
| | | 2017 | 7.86 | 26.42 | - | 51,569 | - | - | 14 | 381 | 395 | 33 | 3.1 | - | - | - | |
| | | 2018 | 7.91 | 24.40 | - | 52,235 | - | - | 15 | 421 | 436 | 48 | 2.1 | - | - | - | |
| | | 2019 | 7.94 | 24.98 | - | 52,137 | - | - | 9 | 318 | 329 | 30 | 2.5 | 1.7 | - | - | |
| | | 2020 | 7.86 | 26.44 | - | 48,384 | - | - | 20 | 395 | 420 | 40 | 2.1 | 6.4 | - | - | |
| FDEP | G1SD0003 | 2015 | 7.94 | 27.45 | 5.9 | 51,200 | - | - | 13 | 1,900 | 1,900 | - | - | - | - | - | |
| | | 2016 | 8.01 | 23.79 | 6.4 | 51,179 | - | - | - | 435 | 435 | - | - | - | - | - | |
| | | 2017 | 7.97 | 25.29 | - | 53,302 | - | - | 4 | 300 | 304 | 33 | 2.7 | - | - | - | |
| | | 2018 | 7.76 | 25.14 | - | 52,544 | - | - | 5 | 364 | 369 | 39 | 2.7 | - | - | - | |
| | | 2019 | 7.96 | 25.21 | - | 52,107 | - | - | 4 | 380 | 384 | 34 | 3.6 | 2.2 | - | - | |
| | | 2020 | 7.94 | 25.77 | - | 49,169 | - | - | 10 | 426 | 438 | 37 | 3.5 | 7.2 | - | - | |
| FDEP | G1SD0006 | 2017 | 7.59 | 26.92 | - | 42,143 | - | - | 4 | 593 | 597 | 71 | 9.7 | - | - | - | |
| | | 2018 | 7.79 | 23.50 | - | 52,392 | - | - | 8 | 476 | 486 | 50 | 4.1 | - | - | - | |
| | | 2019 | 7.80 | 26.31 | - | 51,566 | - | - | 7 | 471 | 480 | 43 | 3.3 | 5.8 | - | - | |
| | | 2020 | 7.82 | 25.36 | - | 43,717 | - | - | 16 | 526 | 544 | 49 | 3.6 | 9.2 | - | - | |

Indicates exceedances of NNC

Exceedances of the chlorophyll-a criterion were also observed in off-site waterbodies in approximately 10% of the values included in the data set which is less than the number of exceedances at the island monitoring sites.

A statistical comparison of measured values of total nitrogen and total phosphorus at on- and off-island waterways from 2015-2020 is given on Figure 2-13. The off-island waterways reflect the SFWMD and FDEP monitoring sites, discussed previously. On-island data reflects the combined data set for all waterways based upon measurements conducted from 2015-2020. The measured total nitrogen concentrations at the off-island monitoring sites exhibit a relatively low degree of variability in measured values from 2015-2020, with the vast majority of values exceeding the NNC of 300 $\mu\text{g/l}$ for total nitrogen. A somewhat higher degree of variability, combined with higher individual values, was observed at the Marco Island monitoring sites.

Measured total phosphorus concentrations also appear to be similar in value between the off-island monitoring sites, with a majority of measured values less than the applicable NNC of 46 $\mu\text{g/l}$ at most off-shore sites. The primary exception to this appears to be Site 16692, located near the CR 92 bridge in Goodland Bay which appears to have slightly higher phosphorus concentrations compared with the remaining off-island sites. A similar pattern was also observed for total nitrogen at this site. Historical phosphorus concentrations at Marco Island monitoring sites appear to be somewhat similar to values measured at the off-island sites, with a much higher degree of variability in individual measurements at the Marco Island sites. There are no known geologic sources of phosphorus in the Marco Island area, so the observed concentrations are due to wetland inflows (which often contain elevated nutrients) and human activities.

A statistical comparison of measured values of chlorophyll-a and Secchi disk depth at on- and off-island monitoring sites from 2015-2020 is given on Figure 2-14. The historical data suggest that a majority of measured chlorophyll-a concentrations in both the on- and off-island sites have met the NNC of 4.9 $\mu\text{g/l}$ for chlorophyll-a, although a large degree of variability has been observed in measured values in the Marco Island waterways.

Measured Secchi disk depths have also been highly variable at both the on- and off-island monitoring sites. A relatively high level of water clarity has been observed at FDEP monitoring Site 16689 (located in the Gulf of Mexico outside of Marco Bay). Secchi disk depths appear to decrease with increasing distance from open water at Sites 16690 (Jolly Bridge) and 16692 (Goodland Bay). Measured Secchi disk depths at the Marco Island monitoring sites appear to be somewhere between the relatively clear water observed in the Gulf of Mexico and Secchi disk measurements conducted at other background sites.

As discussed in a previous section, a large amount of Enterococci data have been collected by the FDOH at monitoring sites located in off-shore waters adjacent to Marco Island. These sites are designated as COLLIER58, COLLIER310, COLLIER311, and COLLIER347, and a complete listing of the data collected at these sites is provided in Appendix A-5.

A tabular summary of annual geometric mean values for Enterococci data collected at the 4 FDOH monitoring sites from 2017-2020 is given in Table 2-8. Geometric mean values for Enterococci are provided for each annual period, along with the number of individual exceedances observed in the data during the monitoring program.

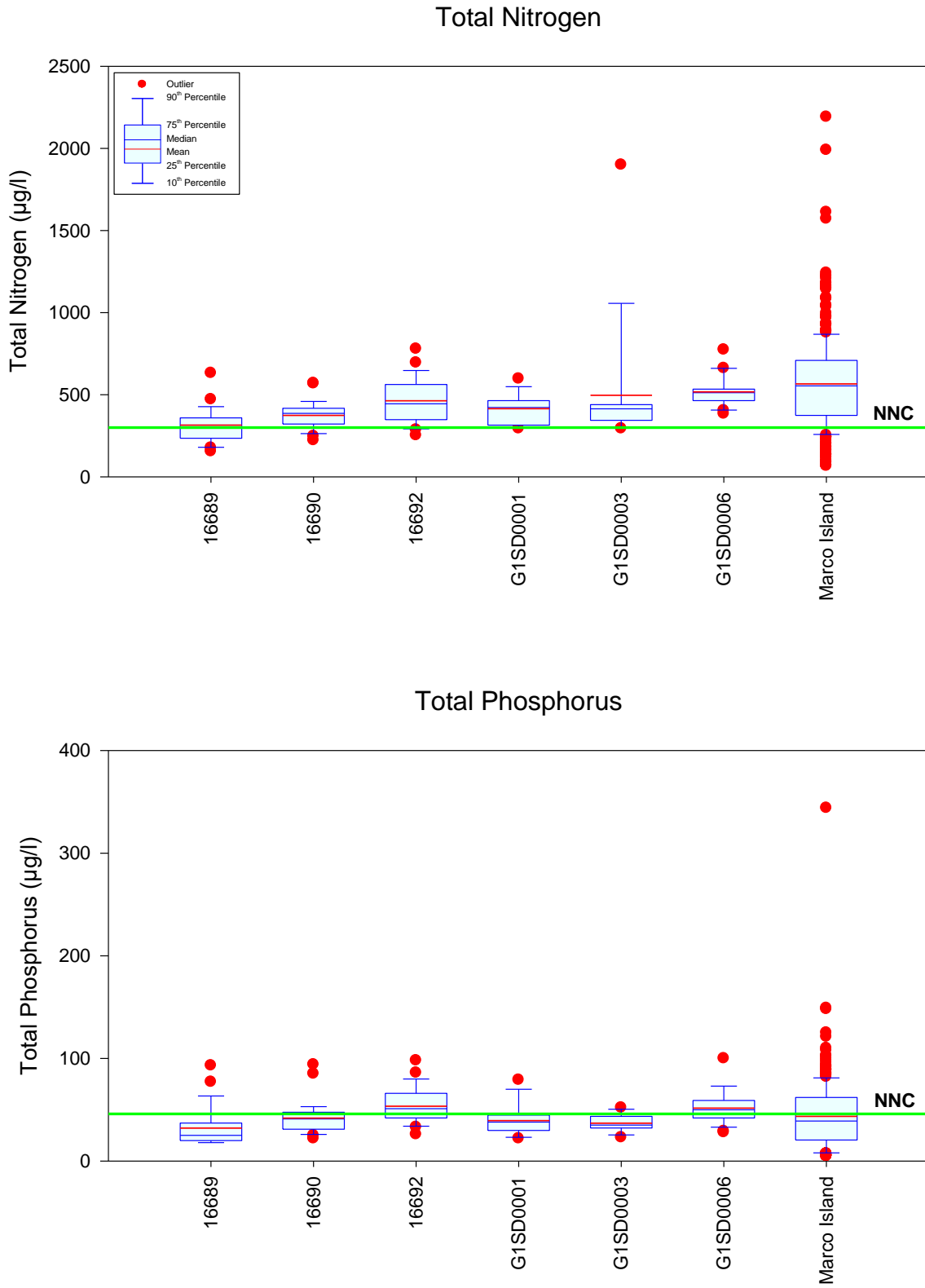

Figure 2-13. Statistical Comparison of Measured Values of Total Nitrogen and Total Phosphorus at On- and Off-Island Waterways from 2015-2020.

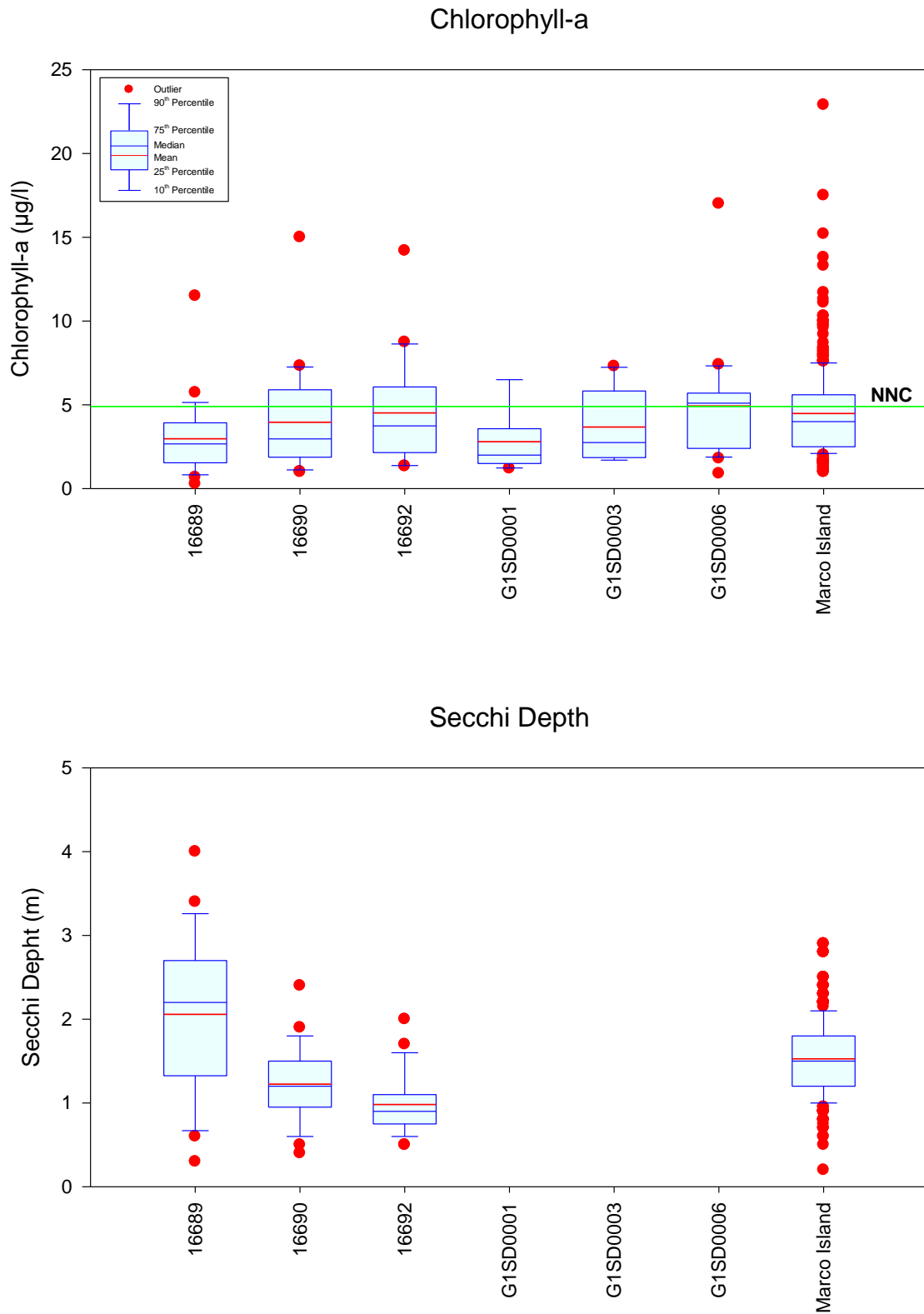

Figure 2-14. Statistical Comparison of Measured Values of Chlorophyll-a and Secchi Disk Depth at On- and Off-Island Waterways from 2015-2020.

TABLE 2-8
HISTORICAL ENTEROCOCCI DATA FOR
WATERBODIES ADJACENT TO MARCO ISLAND

| COLLECTING AGENCY | STATION I.D. | SAMPLE DATE | ANNUAL GEOMETRIC MEAN FOR ENTEROCOCCI (cfu/100 ml) | NUMBER OF EXCEEDANCES |
|-------------------|--------------|-------------|--|-----------------------|
| FDOH | COLLIER58 | 2017 | 10 | 0 |
| | | 2018 | 13 | 4 |
| | | 2019 | 12 | 2 |
| | | 2020 | 10 | 0 |
| FDOH | COLLIER310 | 2017 | 14 | 2 |
| | | 2018 | 16 | 8 |
| | | 2019 | 21 | 13 |
| | | 2020 | 21 | 14 |
| FDOH | COLLIER311 | 2017 | 11 | 1 |
| | | 2018 | 10 | 1 |
| | | 2019 | 12 | 3 |
| | | 2020 | 11 | 0 |
| FDOH | COLLIER347 | 2017 | 10 | 0 |
| | | 2018 | 12 | 3 |
| | | 2019 | 11 | 1 |
| | | 2020 | 11 | 1 |

As indicated on Figure 2-11, monitoring sites designated as COLLIER58, COLLIER310, and COLLIER311 are located in off-shore waters on the west side of Marco Island. Geometric mean Enterococci counts at these sites have been generally low in value, and each of the annual geometric mean values easily meets the Enterococci criterion of 35 cfu/100 ml. Although the geometric mean values meet the applicable criterion, individual exceedances of the criterion have been observed in samples collected at each of the 3 monitoring sites, with the most exceedances observed at COLLIER310 which is located in the northern half of the island. An additional monitoring site, designated as COLLIER347, is located along the southern portion of the island adjacent to the Gulf of Mexico. This site has exhibited extremely low annual geometric mean Enterococci values with only a limited number of individual exceedances.

A statistical comparison of measured Enterococci values for on- and off-island waterways from 2015-2020 is given on Figure 2-15. The vast majority of collected samples in both the on- and off-island monitoring sites easily met the Enterococci criterion, although individual exceedances of the criterion have been observed at each site. The observed exceedances at the Marco Island waterways sites have included substantially higher values than observed at the remaining sites. Please note that the scale for Enterococci values is a logarithmic scale, suggesting that some values measured in Marco Island waterways have exceeded the NNC by 2 orders of magnitude or more, although in general Enterococci counts are typically low in value.

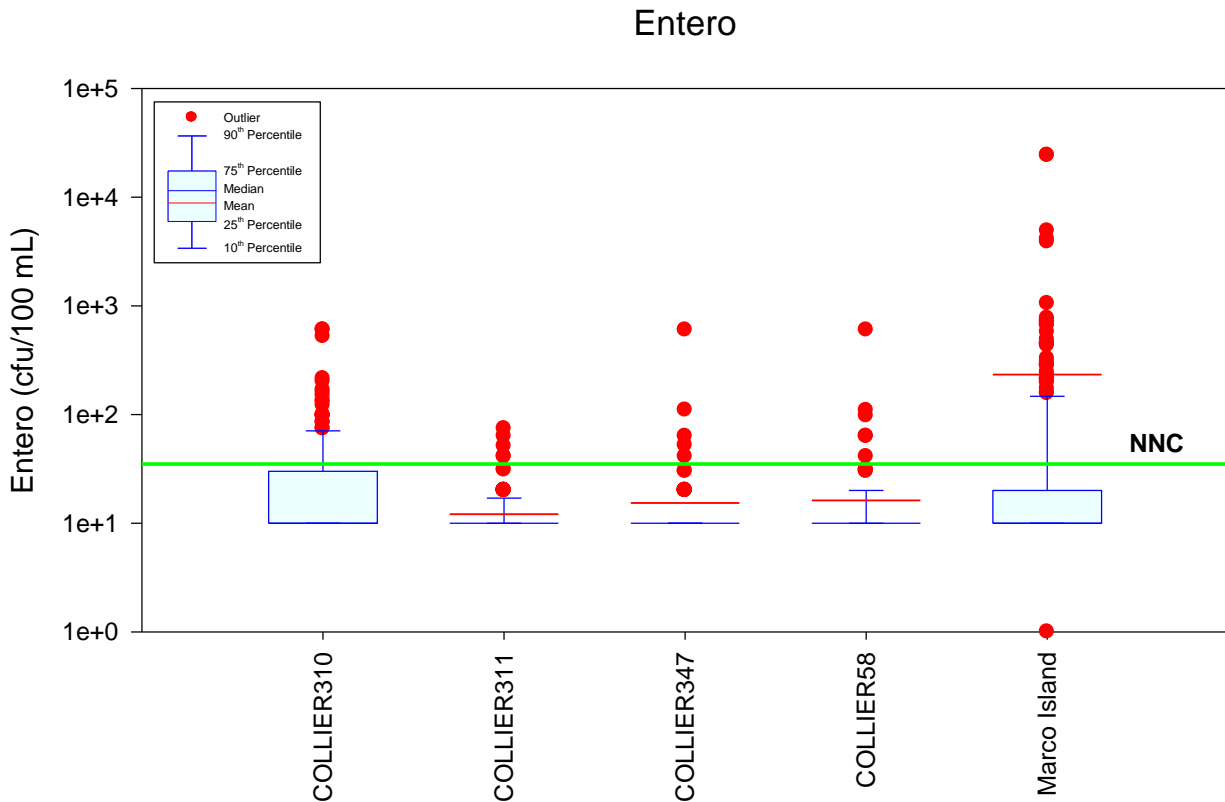

Figure 2-15. Statistical Comparison of Measured Enterococci Counts at On- and Off-Island Waterways from 2015-2020.

2.2.2.3 Impacts from Off-Island Communities

Multiple people have expressed concern to ERD about potential water quality impacts from off-island communities such as Goodland and Isles of Capri which primarily use septic tanks for wastewater disposal. Water quality impacts from septic tanks would be observed as elevated nutrients and Enterococci in off-shore waters adjacent to the communities.

A large amount of historical water quality data has been collected near each of these communities. Unfortunately, consistent data collection near Isles of Capri ended in 2011 at the nearby sites. The closest current water quality monitoring site is FDEP Site GISD0001 which is located in Marco Bay Channel and has daily tidal cycles which continuously move and replace the water, making detection of water quality impacts difficult.

In contrast, current water quality data are available at 2 separate monitoring sites near Goodland, consisting of SFWMD Site 16692 (which has current data for nutrients, general parameters, and chlorophyll-a), and FDEP Site GISD0006 (which has weekly data for Enterococcus). A comparison of concentrations of total nitrogen and total phosphorus at off-shore monitoring sites is provided in Figure 2-13. Both Sites 16692 and GISD0006 appear to have the highest measured concentrations of total nitrogen and total phosphorus compared with other off-shore sites, although the differences are probably not statistically significant. As indicated on Figure 2-14, these sites also appear to have the highest median values for chlorophyll-a, although the trend is not as distinct as observed for total nitrogen and total phosphorus.

2.2.2.4 Summary

A substantial amount of historical water quality has been collected on off-shore waters. From 2015-2020, off-shore sites surrounding Marco Island exhibited AGM values for total nitrogen which exceeded the NNC of 300 µg/l during 28 of the 30 annual periods at SFWMD and FDEP monitoring sites. Exceedances of the NNC for total phosphorus were observed during 9 of the 27 annual periods (33%), with exceedances of the NNC for chlorophyll-a during 3 of the 27 annual periods. Exceedances in Enterococci counts have also been observed on the northwest shoreline of the island, particularly in recent years. Off-shore areas provide the baseline water quality for Marco Island waterways and reflect water quality characteristics which would be present if no additional inputs occurred from Marco Island. Marco Island can, and does, add to existing concentrations but cannot reduce nutrient levels below the existing elevated levels. NNC criteria cannot be met in Marco Island waterways until the baseline water quality meets NNC.

2.3 Current Water Quality Characteristics

2.3.1 Monitoring Activities

A monthly surface water quality monitoring program was conducted in Marco Island waterways and off-shore waters by ERD from April-September 2020 at 17 fixed monitoring locations. Locations of the surface water monitoring sites used by ERD are indicated on Figure 2-16. The surface water monitoring sites were selected to provide general information on ambient water quality characteristics, evaluate horizontal and vertical water quality variability, and assist in identifying potential significant loading sources. Water quality monitoring was conducted on a monthly basis with a total of 6 monitoring events conducted at each of the 17 sites.

Sample collection procedures generally followed methods outlined in DEP-SOP-001/01 titled “Department of Environmental Protection Standard Operating Procedures for Field Activities” dated April 16, 2018. Surface water samples were collected using a battery-powered peristaltic pump constructed of plastic and stainless steel. All samples were collected at a depth equal to 50% of the Secchi disk depth at the time of sample collection. Each of the collected samples was preserved as appropriate for the parameter to be analyzed, stored in ice, and returned to the ERD Laboratory for chemical analyses. A listing of laboratory analyses performed on the collected samples is given in Table 2-9, along with a summary of analytical methods and laboratory detection limits.

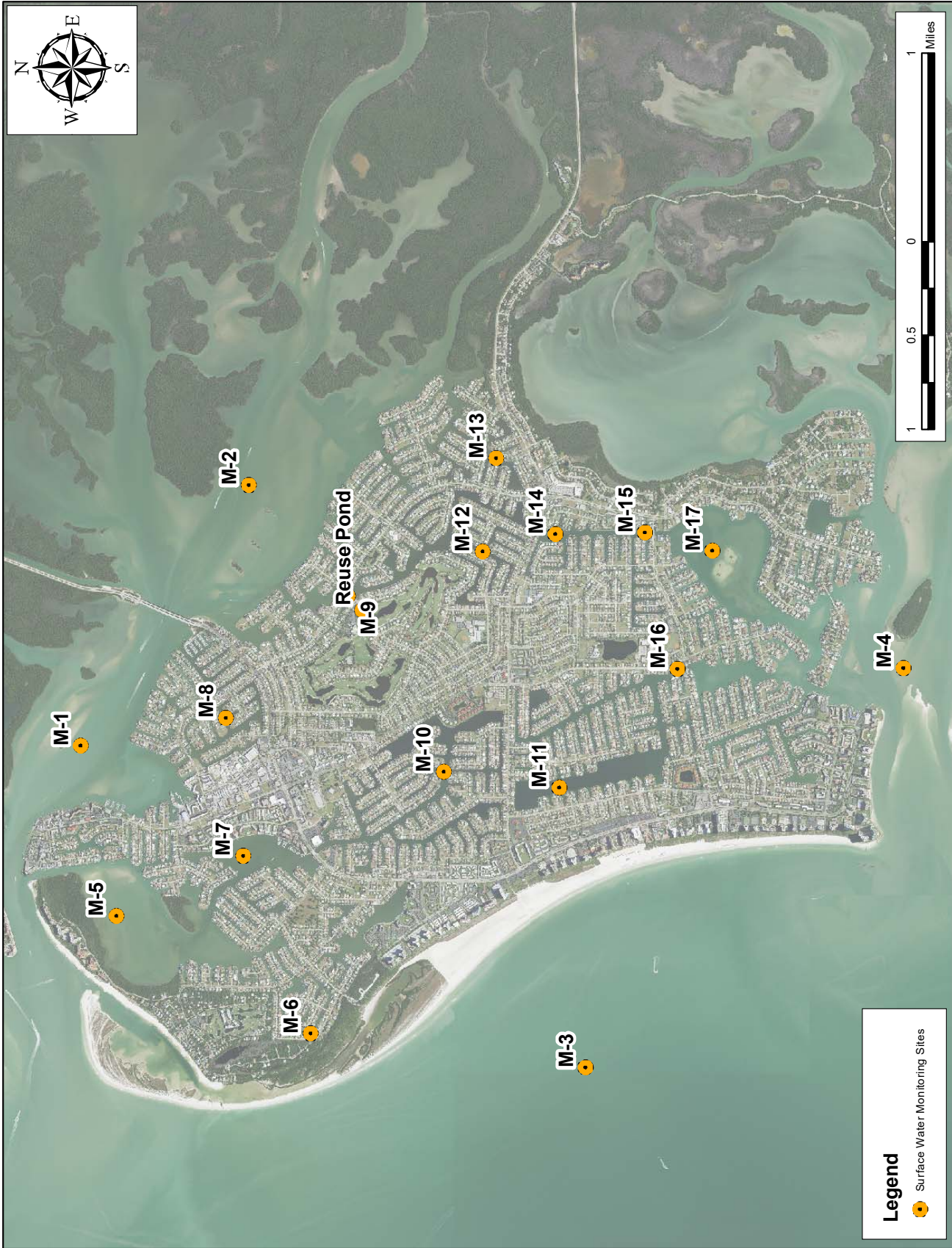

Figure 2-16. Surface Water Monitoring Sites Used by ERD.

TABLE 2-9

**ANALYTICAL METHODS AND DETECTION LIMITS
FOR FIELD AND LABORATORY ANALYSES CONDUCTED
BY ENVIRONMENTAL RESEARCH AND DESIGN, INC.**

| MEASUREMENT PARAMETER | | METHOD | LOCATION | METHOD DETECTION LIMITS (MDLs) ¹ |
|-----------------------|--|-------------------------------------|----------|---|
| Field Parameters | Hydrogen Ion (pH) | DEP-SOP-FT ² 1100 | Field | NA |
| | Specific Conductivity | DEP-SOP-FT 1200 | Field | 0.3 µmho/cm |
| | Temperature | DEP-SOP-FT 1400 | Field | NA |
| | Dissolved Oxygen | DEP-SOP-FT 1500 | Field | 0.2 mg/l |
| | Secchi Disk Depth | DEP-SOP-FT 1700 | Field | NA |
| | ORP | DEP-SOP-FT 2100 | Field | NA |
| General Parameters | Alkalinity | SM-22 ³ , Sec. 2320 B | ERD Lab | 1.4 mg/l |
| | Turbidity | SM-22, Sec. 2130 B | ERD Lab | 0.3 NTU |
| | Color | SM-22, Sec. 2120 C | ERD Lab | 1 Pt-Co unit |
| Nutrients | Nitrate + Nitrite (NO _x -N) | SM-22, Sec. 4500-NO ₃ ,F | ERD Lab | 0.002 mg/l |
| | Ammonia N (NH ₃ -N) | SM-22, Sec. 4500-NH ₃ ,G | ERD Lab | 0.010 mg/l |
| | Total Nitrogen | SM-22, Sec. 4500 N C | ERD Lab | 0.014 mg/l |
| | Orthophosphorus (SRP) | SM-22, Sec. 4500 P F | ERD Lab | 0.001 mg/l |
| | Total Phosphorus | SM-22, Sec. 4500 P F | ERD Lab | 0.002 mg/l |
| Biological Parameters | Chlorophyll-a | SM-22, Sec. 10200 H.3 | ERD Lab | 0.1 µg/l |
| | Enterococcus | SM-22, Sec. 9230 C | ERD Lab | 1 cfu/100 ml |

1. MDLs are calculated based on the EPA method of determining detection limits
2. Standard Operating Procedures for Field Activities, DEP-SOP-001/01, April 16, 2018
3. Standard Methods for the Examination of Water and Wastewater, 22nd Edition, 2012

During each monitoring event, vertical profiles of pH, temperature, conductivity, dissolved oxygen, oxidation reduction potential (ORP), and turbidity were conducted at each site. Field measurements were collected at water depths of 0.5 m and 1.0 m, and at 1.0 m intervals to the bottom at each site. All field measurements were performed using Hydrolab Surveyor 4a and Data Sonde 4 units. A measurement of Secchi disk depth was also performed at each site.

2.3.2 Field Profiles

A complete listing of vertical field profile data collected at the Marco Island monitoring sites from April-September 2020, and graphical plots of the field measurements for each site, are given in Appendix B-1. A discussion of the results of the vertical profile data is given in the following sections.

2.3.2.1 Off-Island Monitoring Sites

As indicated on Figure 2-16, 4 of the 17 water quality monitoring sites used by ERD are located in off-shore waters around the perimeter of Marco Island and are designated as Sites M-1 through M-4. In general, vertical field profiles collected at each of these sites were virtually isograde during each monitoring event. A graphical summary of vertical field profiles collected at Site M-3 is given in Figure 2-17 as an example of a typical off-island monitoring location. Although water depths varied between the 4 off-shore monitoring sites, the vertical field profiles were virtually identical, indicating no vertical stratification for temperature, pH, salinity, dissolved oxygen, or oxidation-reduction potential (ORP).

Each of the 4 off-island sites maintained adequate levels of dissolved oxygen to support aquatic wildlife, and easily met the Class III dissolved oxygen criterion of a minimum of 42% saturation within the top 2 m for marine waters. The water column at each of the off-shore sites was well oxidized from top to bottom during each monitoring event. Overall, vertical profiles collected at these sites suggest an extremely well mixed water column at each site due to the virtually continuous water movement.

2.3.2.2 On-Island Waterways Monitoring Sites

Vertical field profiles collected in the Marco Island waterways did not exhibit the consistent steady values observed at the off-shore sites. As an example, vertical field profiles collected in Marco Island at Site M-9 (located in mid portions of the waterway system associated with Sub-basin 3) are illustrated on Figure 2-18. Slight decreases were observed for both temperature and pH with increasing water depth, while salinity values generally increased slightly with increasing water depth.

A slight decrease is apparent in concentrations of dissolved oxygen with increasing depth, although measured values generally remained greater than 4 mg/l. A similar pattern is also apparent for dissolved oxygen saturation, with super-saturated conditions observed in surface layers of the water column during several events, generally indicative of a surface algal bloom. Dissolved oxygen decreased slightly with increasing depth, but remained above the minimum Class III criterion of 42%. The water column was generally oxidized at all depths.

In contrast, vertical profiles collected at monitoring locations located in upstream portions of waterways often exhibited significant stratification for 1 or more parameters. The best example of this was observed at monitoring site M-11, and a compilation of vertical field profiles collected at this site is given in Figure 2-19. This is one of the deeper sites and is located in an upstream portion of a wide canal system with little or no tidal flushing.

As seen on Figure 2-19, decreases in both temperature and pH were observed with increasing water depth during virtually all events. In contrast, salinity typically increased with increasing water depth before decreasing substantially near the water-sediment interface. This reduction in salinity is likely due to impacts from freshwater seeping into the bottom and sides of the canal system. Measured concentrations and saturation percentages for dissolved oxygen also decreased steadily with increasing water depth, although this site easily met the dissolved oxygen criterion of 42% saturation in the top 2 m. Lower portions of the water column exhibited reduced conditions during each of the 6 monitoring events which limits biological communities and increases the potential for nutrient recycling in the canal system.

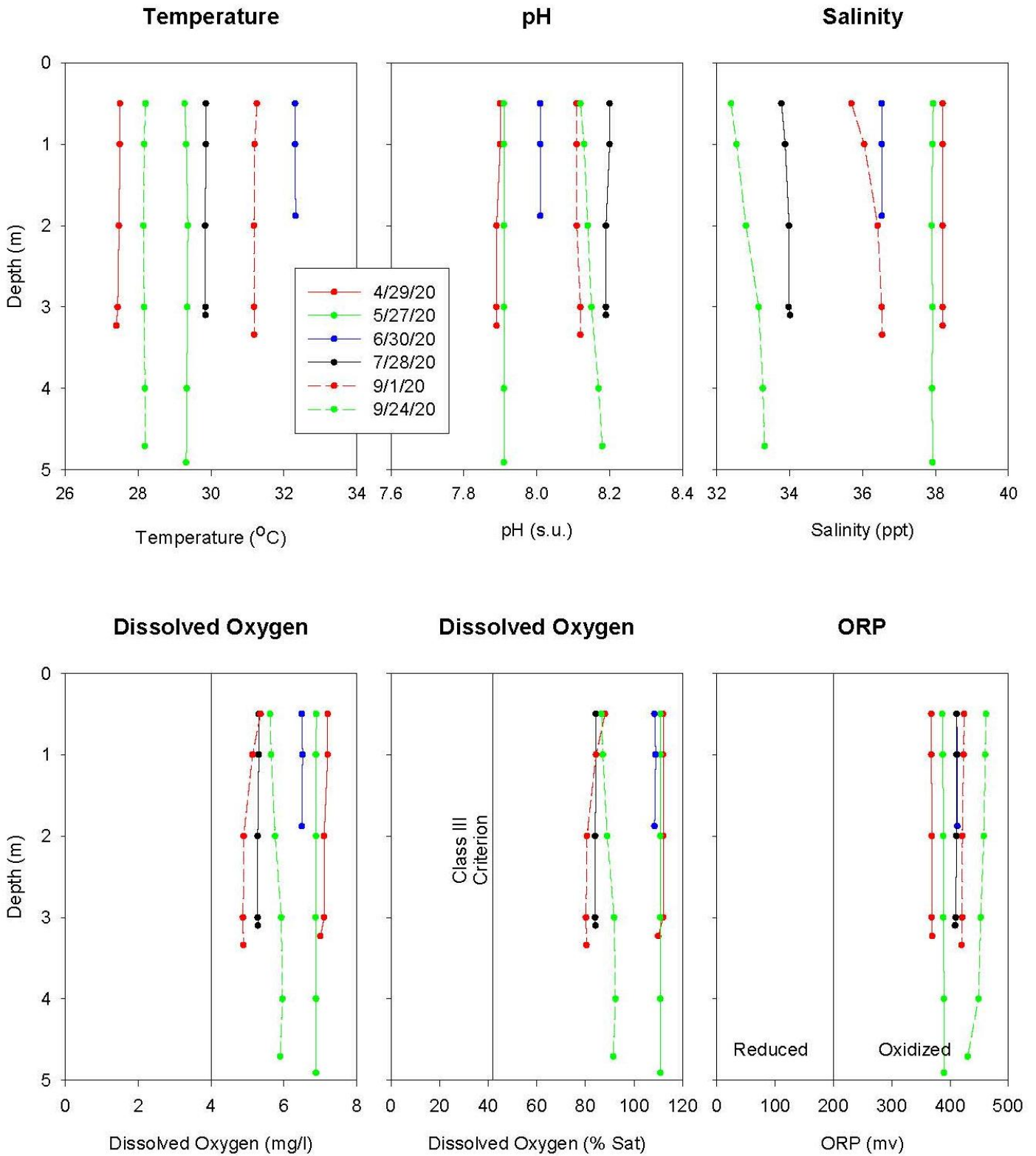

Figure 2-17. Vertical Field Profiles Collected in Marco Island at Site M-3.

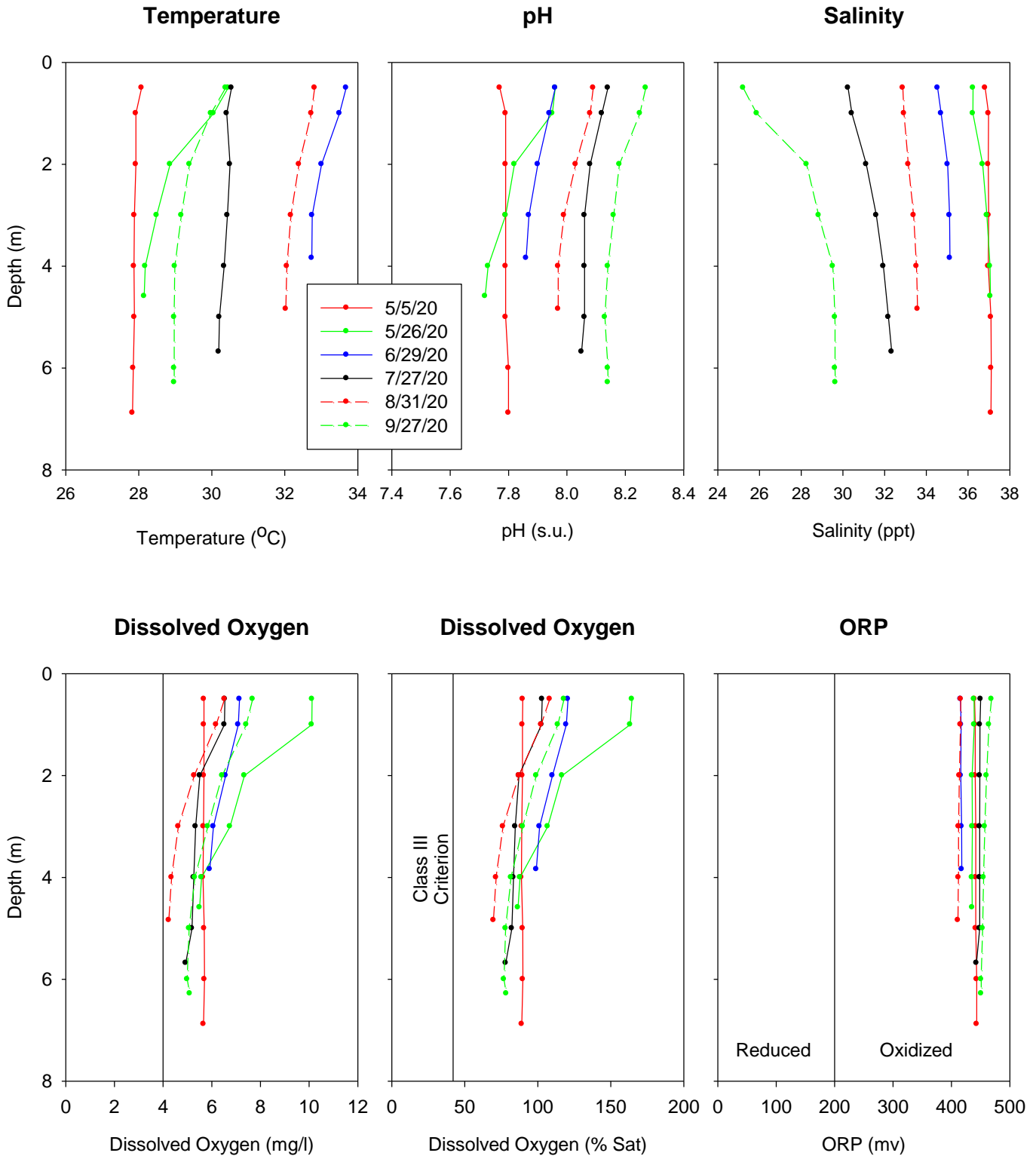

Figure 2-18. Vertical Field Profiles Collected in Marco Island at Site M-9.

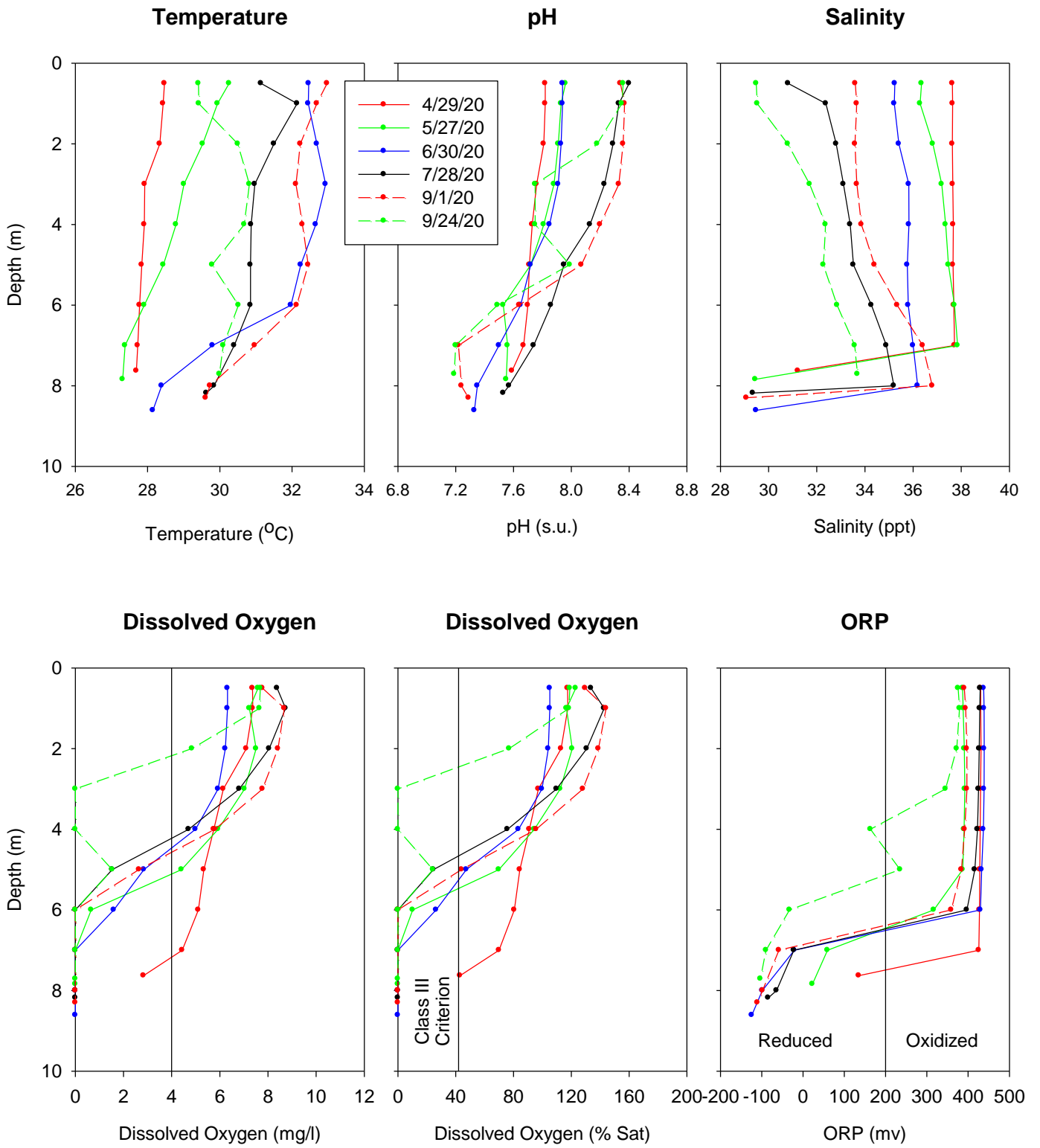

Figure 2-19. Vertical Field Profiles Collected in Marco Island at Site M-11.

The vertical profiles illustrated for Site M-9 and Site M-11 reflect 2 extremes of the monitored data during the field monitoring program observed in island waterways. Many of the sites exhibited patterns mid-way between those exhibited by Sites M-9 and M-11, with periodic stratification and conditions of low dissolved oxygen in lower portions of the water column which did not occur during all events. Many of these sites appear to be located in mid portions of waterway systems.

A summary of information obtained from vertical field profile data collected at the off-island and on-island monitoring sites is given in Table 2-10. Information is provided for each monitoring site regarding measured water depth, presence of stratification for temperature or pH, compliance with dissolved oxygen criterion, observed oxygen decreases near the water-sediment interface, changes in the water conductivity at the water-sediment interface, and presence of reduced conditions near the water-sediment interface. The only site which appears to exhibit thermal stratification is Site M-11 which was discussed previously. Approximately half of the monitoring sites exhibited pH stratification in lower portions of the water column which generally indicates a high degree of microbial activity within the sediments. Each of the sites easily met the dissolved oxygen criterion, although decreases in dissolved oxygen in lower portions of the water column were observed at multiple monitoring sites, all of which appear to be located in the southern half of the island.

Changes in conductivity at the water-sediment interface are indicative of external inflows or microbial activity which is releasing ions into the water column. Conditions such as these were observed during about one-third of the monitoring events primarily at locations in the southern half of Marco Island. Reduced conditions at the water-sediment interface were observed from 1-6 of the 6 monitoring events, also at sites located in the southern half of the island.

2.3.3 Chemical Characteristics

A summary of laboratory analyses conducted on surface water samples collected at each of the 17 monitoring sites from April-September 2020 is given Appendix B-2 which also includes simple descriptive statistics for parameters monitored at each site.

2.3.3.1 Impacts of Tidal Events

The surface water monitoring program conducted by ERD was designed to include monitoring conducted under both incoming and outgoing tidal conditions to assist in evaluating nutrient dynamics within the waterways. Three separate monitoring events were conducted for both incoming and outgoing characteristics, with incoming tidal conditions during April, June, and September and outgoing tidal conditions during May, July, and August.

TABLE 2-10

**SUMMARY OF VERTICAL PROFILE DATA COLLECTED
AT MARCO ISLAND FROM APRIL-SEPTEMBER 2020**

| SITE | PARAMETER | | | | | | |
|------|-----------------|------------------------|-------------------|--------------------------------|---------------------------------------|---|--|
| | Water Depth (m) | Thermal Stratification | pH Stratification | Met Dissolved Oxygen Criterion | Dissolved Oxygen Decrease Near Bottom | Conductivity Change at Water-Sediment Interface | Reduced Conditions at Water-Sediment Interface |
| M-1 | 1.8 - 2.6 | No | No | Yes | No | No | No |
| M-2 | 1.3 - 2.0 | No | No | Yes | No | No | No |
| M-3 | 3.2 - 4.9 | No | No | Yes | No | No | No |
| M-4 | 3.6 - 4.2 | No | No | Yes | No | No | No |
| M-5 | 1.3 - 2.2 | No | No | Yes | No | No | No |
| M-6 | 2.9 - 4.4 | No | No | Yes | No | No | No |
| M-7 | 1.9 - 4.3 | No | Slight | Yes | No | No | No |
| M-8 | 2.4 - 2.8 | No | Slight | Yes | No | No | No |
| M-9 | 3.8 - 6.9 | No | No | Yes | No | No | No |
| M-10 | 3.6 - 4.2 | No | No | Yes | 6 of 6 events | 1 of 6 events | 1 of 6 events |
| M-11 | 7.6 - 8.6 | Yes | 6 of 6 events | Yes | 6 of 6 events | Yes | 6 of 6 events |
| M-12 | 2.2 - 3.6 | No | Slight | Yes | 1 of 6 events | 1 of 6 events | 2 of 6 events |
| M-13 | 2.9 - 3.8 | No | 6 of 6 events | Yes | 4 of 6 events | 2 of 6 events | 3 of 6 events |
| M-14 | 3.7 - 4.2 | No | 3 of 6 events | Yes | 6 of 6 events | 2 of 6 events | 4 of 6 events |
| M-15 | 5.2 - 7.7 | No | No | Yes | No | No | 1 of 6 events |
| M-16 | 3.3 - 8.4 | No | No | Yes | No | No | No |
| M-17 | 5.7 - 7.3 | No | 3 of 6 events | Yes | 5 of 6 events | 2 of 6 events | 3 of 6 events |

A summary of water quality characteristics in off-island surface water samples collected during incoming and outgoing tidal conditions from April-September 2020 is given in Table 2-11. Surface water monitoring was conducted for a period of 6 months, with 3 samples collected under incoming tide conditions and 3 samples collected under outgoing tide conditions. Due to the relatively small amount of available data, it becomes more difficult to detect trends or differences in water quality characteristics between tidal conditions, although some patterns are clearly visible in the data. For example, measured alkalinity values appear to be greater during incoming tidal conditions as well buffered and highly alkaline seawater encroaches into the waterways. Outgoing tides carry a combination of seawater as well as inflows from Marco Island and adjacent tributaries which generally have lower salinity and lower alkalinity values.

TABLE 2-11

**WATER QUALITY CHARACTERISTICS OF OFF-ISLAND
SURFACE WATER SAMPLES COLLECTED DURING INCOMING AND
OUTGOING TIDAL CONDITIONS FROM APRIL-SEPTEMBER 2020**

| LOCATION | TIDE CONDITION | PARAMETER | | | | | | | | | | | | |
|----------|-------------------|----------------------|---------------------|------------------------------|---------------------------|-------------------------|-------------------|---------------|---------------------------|-------------------------|-------------------|--------------------|------------------|-------------------------|
| | | Alkalinity (mg/l) | Ammonia N (µg/l) | NO _x -N (µg/l) | Diss. Organic N (µg/l) | Particulate N (µg/l) | Total N (µg/l) | SRP (µg/l) | Diss. Organic P (µg/l) | Particulate P (µg/l) | Total P (µg/l) | Turbidity (NTU) | Color (Pt-Co) | Chlorophyll-a (µg/l) |
| M-1 | In | 135 | 3 | 3 | 443 | 129 | 580 | 21 | 7 | 7 | 36 | 2.7 | 5 | 8.7 |
| | Out | 130 | 5 | 4 | 390 | 159 | 588 | 21 | 6 | 10 | 39 | 5.3 | 6 | 12.5 |
| M-2 | In | 137 | 8 | 4 | 378 | 134 | 555 | 30 | 3 | 6 | 40 | 3.7 | 9 | 12.5 |
| | Out | 139 | 3 | 6 | 440 | 217 | 688 | 27 | 7 | 10 | 44 | 12.7 | 15 | 17.7 |
| M-3 | In | 139 | 6 | 6 | 479 | 47 | 558 | 24 | 4 | 9 | 38 | 2.3 | 2 | 8.0 |
| | Out | 128 | 6 | 6 | 486 | 96 | 602 | 21 | 3 | 5 | 31 | 2.3 | 7 | 10.3 |
| M-4 | In | 132 | 6 | 3 | 476 | 29 | 520 | 22 | 2 | 16 | 42 | 4.0 | 2 | 8.9 |
| | Out | 130 | 5 | 7 | 448 | 36 | 513 | 30 | 3 | 10 | 43 | 2.1 | 7 | 6.9 |

Measured total nitrogen concentrations at 3 of the 4 off-shore monitoring sites exhibited highest concentrations during outgoing tides which suggests nutrient enrichment from incoming water sources which exits during outgoing tidal conditions. A similar pattern is also observed for total phosphorus at most sites, with the most elevated values observed during outgoing tidal conditions, suggesting enrichment of nutrients to off-island waterbodies from external sources. Measured values for color are also greater during outgoing tide conditions since many of the inflows to off-island surface waters come from highly colored sources. Chlorophyll-a concentrations also appear to be greater during outgoing tide conditions, with the exception of the Gulf of Mexico Site (M-4).

A summary of water quality characteristics of surface water samples collected in island waterways during incoming and outgoing tidal conditions is given in Table 2-12. With only a few exceptions, measured alkalinity values within the island waterways are higher during incoming tidal conditions than during outgoing tides for the same reasons discussed previously for the off-island sites. Measured concentrations of total nitrogen also appear to be greatest at 7 of the 13 island waterway sites during outgoing tidal conditions, indicating that the tide is removing nutrients entering the system between tidal cycles. A notable exception to this generality is monitoring Site M-11 which is located in the extreme upstream portion of a wide, deep canal system. At this location, outgoing concentrations of total nitrogen appear to be substantially lower than values observed under incoming conditions.

Measured concentrations of total phosphorus appear to exhibit a mixture of tidal conditions under which more elevated concentrations are observed. Five of the island waterway monitoring sites discharge lower concentrations of total phosphorus during outgoing tidal conditions than enter the system through tidal inflows, suggesting that either uptake occurs within the waterways for phosphorus inputs transported by tidal influx or watershed inflows are more dilute which reduces canal concentrations. However, the remaining sites exhibit higher concentrations under outgoing conditions, suggesting enrichment of phosphorus concentrations in these areas from watershed sources.

Virtually all island waterway sites exhibit lower concentrations of turbidity during outgoing tidal conditions than during incoming tide. This phenomenon suggests that particulate matter introduced into the system by the incoming tide is being removed within the waterways between tidal events, although this removal of particulate matter adds to accumulation of sediments within the waterways.

A majority of the monitoring sites exhibit slightly higher color values during outgoing tide than during incoming tide conditions. Since ocean water generally has low color concentrations, increases in color observed under outgoing tidal conditions suggest influx of color-causing compounds from watershed areas into the waterways.

A mixture of tidal impacts is also apparent for chlorophyll-a. Five of the waterway monitoring sites discharge higher concentrations of chlorophyll-a during outgoing tides than enters the system during incoming tides. However, the remaining sites exhibit higher concentrations in the tidal inflow than in outflow, suggesting that chlorophyll-a may be removed within the system as algal particles die and accumulate into the sediments.

2.3.3.2 Comparison of Water Quality Characteristics

A summary of overall geometric mean water quality characteristics of surface water samples collected at off-island monitoring sites from April-September 2020 is given in Table 2-13. Measured chemical characteristics for virtually all parameters appear to be similar between the 4 off-island monitoring locations, although the Gulf of Mexico site (M-4) exhibited the lowest value for total nitrogen, color, and chlorophyll-a. The off-island sites are characterized by extremely low levels of both ammonia and NO_x , with the vast majority of nitrogen present as dissolved organic nitrogen. The lack of significant dissolved inorganic nitrogen (DIN) is likely the limiting factor for algal productivity at these sites. Somewhat elevated values of particulate nitrogen were observed at Sites M-1 and M-2 which is likely due to resuspension of particulate matter resulting from tidal movement through the system.

TABLE 2-12

**WATER QUALITY CHARACTERISTICS OF ISLAND WATERWAY
SURFACE WATER SAMPLES COLLECTED DURING INCOMING AND
OUTGOING TIDAL CONDITIONS FROM APRIL-SEPTEMBER 2020**

| LOCATION | TIDE CONDITION | PARAMETER | | | | | | | | | | | | |
|----------|-------------------|-----------------------|---------------------|------------------------------|---------------------------|-------------------------|-------------------|---------------|---------------------------|-------------------------|-------------------|--------------------|------------------|-------------------------|
| | | Alkalinity (m/g/l) | Ammonia N (µg/l) | NO _x -N (µg/l) | Diss. Organic N (µg/l) | Particulate N (µg/l) | Total N (µg/l) | SRP (µg/l) | Diss. Organic P (µg/l) | Particulate P (µg/l) | Total P (µg/l) | Turbidity (NTU) | Color (Pt-Co) | Chlorophyll-a (µg/l) |
| M-5 | In | 139 | 3 | 4 | 482 | 48 | 559 | 23 | 10 | 12 | 48 | 6.3 | 5 | 11.0 |
| | Out | 139 | 3 | 7 | 422 | 93 | 595 | 21 | 9 | 11 | 42 | 4.1 | 6 | 11.6 |
| M-6 | In | 138 | 9 | 4 | 427 | 76 | 523 | 28 | 6 | 12 | 46 | 2.2 | 8 | 15.4 |
| | Out | 135 | 8 | 9 | 477 | 114 | 628 | 28 | 3 | 11 | 43 | 2.3 | 9 | 14.3 |
| M-7 | In | 144 | 6 | 3 | 469 | 49 | 533 | 22 | 15 | 10 | 48 | 2.9 | 7 | 15.8 |
| | Out | 131 | 5 | 6 | 478 | 63 | 577 | 23 | 12 | 9 | 44 | 2.6 | 7 | 14.5 |
| M-8 | In | 135 | 3 | 5 | 484 | 102 | 605 | 21 | 9 | 12 | 43 | 2.9 | 9 | 17.5 |
| | Out | 123 | 5 | 4 | 464 | 138 | 625 | 18 | 11 | 18 | 48 | 1.8 | 9 | 11.5 |
| M-9 | In | 137 | 9 | 4 | 508 | 71 | 599 | 26 | 4 | 13 | 43 | 3.0 | 12 | 13.0 |
| | Out | 133 | 5 | 4 | 434 | 143 | 594 | 27 | 5 | 14 | 47 | 1.8 | 13 | 15.6 |
| M-10 | In | 134 | 3 | 3 | 457 | 70 | 559 | 26 | 15 | 11 | 52 | 1.7 | 9 | 16.1 |
| | Out | 132 | 5 | 4 | 435 | 112 | 611 | 17 | 15 | 7 | 41 | 1.2 | 11 | 12.9 |
| M-11 | In | 132 | 3 | 4 | 401 | 117 | 569 | 24 | 15 | 10 | 50 | 1.3 | 6 | 16.8 |
| | Out | 133 | 3 | 5 | 254 | 137 | 478 | 24 | 12 | 16 | 57 | 0.8 | 10 | 13.3 |
| M-12 | In | 142 | 7 | 3 | 529 | 85 | 637 | 24 | 8 | 7 | 40 | 1.6 | 14 | 9.5 |
| | Out | 140 | 5 | 7 | 452 | 149 | 624 | 25 | 13 | 10 | 48 | 1.1 | 12 | 24.8 |
| M-13 | In | 145 | 13 | 4 | 485 | 108 | 699 | 19 | 12 | 16 | 48 | 2.3 | 16 | 14.3 |
| | Out | 132 | 3 | 4 | 502 | 158 | 692 | 19 | 10 | 9 | 40 | 1.9 | 14 | 24.9 |
| M-14 | In | 131 | 3 | 5 | 555 | 100 | 669 | 17 | 6 | 12 | 36 | 2.4 | 6 | 16.8 |
| | Out | 137 | 5 | 6 | 546 | 137 | 700 | 23 | 3 | 11 | 39 | 1.3 | 8 | 14.3 |
| M-15 | In | 140 | 3 | 2 | 488 | 46 | 557 | 20 | 8 | 6 | 34 | 2.4 | 5 | 14.7 |
| | Out | 134 | 3 | 4 | 448 | 51 | 514 | 29 | 8 | 9 | 46 | 2.5 | 10 | 14.5 |
| M-16 | In | 138 | 5 | 3 | 390 | 122 | 525 | 22 | 10 | 9 | 43 | 2.6 | 4 | 11.7 |
| | Out | 138 | 5 | 3 | 334 | 77 | 433 | 25 | 9 | 10 | 45 | 1.9 | 8 | 12.7 |
| M-17 | In | 137 | 3 | 3 | 480 | 53 | 540 | 22 | 6 | 10 | 41 | 3.6 | 4 | 10.8 |
| | Out | 135 | 5 | 4 | 479 | 137 | 632 | 29 | 11 | 10 | 52 | 2.7 | 10 | 8.4 |

TABLE 2-13

**GEOMETRIC MEAN WATER QUALITY CHARACTERISTICS
OF SURFACE WATER SAMPLES COLLECTED AT OFF-ISLAND
SITES FROM APRIL-SEPTEMBER 2020**

| LOCATION | PARAMETER | | | | | | | | | | | | |
|----------|----------------------|---------------------|------------------------------|---------------------------|-------------------------|-------------------|---------------|---------------------------|-------------------------|-------------------|--------------------|------------------|-------------------------|
| | Alkalinity (m/gl) | Ammonia N (µg/l) | NO _x -N (µg/l) | Diss. Organic N (µg/l) | Particulate N (µg/l) | Total N (µg/l) | SRP (µg/l) | Diss. Organic P (µg/l) | Particulate P (µg/l) | Total P (µg/l) | Turbidity (NTU) | Color (Pt-Co) | Chlorophyll-a (µg/l) |
| M-1 | 133 | 4 | 3 | 416 | 143 | 584 | 21 | 6 | 9 | 38 | 3.8 | 5 | 10.4 |
| M-2 | 138 | 5 | 5 | 408 | 170 | 618 | 28 | 5 | 8 | 42 | 6.9 | 12 | 14.9 |
| M-3 | 133 | 6 | 6 | 482 | 67 | 579 | 23 | 3 | 7 | 35 | 2.3 | 4 | 9.0 |
| M-4 | 131 | 5 | 5 | 462 | 32 | 517 | 26 | 3 | 13 | 43 | 2.9 | 4 | 7.8 |

In contrast to the trend observed for total nitrogen, the off-shore monitoring sites appear to have abundant dissolved inorganic phosphorus (DIP) in the form of soluble reactive phosphorus (SRP). The data suggest an abundance of phosphorus with the shortage of nitrogen limiting algal productivity. Dissolved SRP comprises the dominant form of phosphorus present in the off-shore surface waters, contributing 50-60% or more of the overall total phosphorus concentration. Measured color values at the off-shore sites are generally low in value, with the most elevated color observed at monitoring Site M-2 which is located in an area receiving significant inflows from adjacent waterways.

Measured chlorophyll-a concentrations were slightly elevated in the off-shore monitoring sites, with geometric mean values ranging from 7.8-14.9 µg/l. However, the monitoring program was conducted during the most productive portion of the year, and chlorophyll-a values measured during winter conditions would likely be lower.

A tabular summary of geometric mean concentrations in surface water samples collected in Marco Island waterways from April-September 2020 is given on Table 2-14. Similar to the trends observed for the off-shore sites, waterway samples contained extremely low levels of dissolved inorganic nitrogen which likely limits algal productivity in these areas. The dominant nitrogen form present at each site was dissolved organic nitrogen which comprises 80-90% of the overall nitrogen present. Measured particulate nitrogen concentrations ranged from relatively low to slightly elevated, depending upon location. Measured total nitrogen concentrations during the field monitoring program appear to be similar to long-term historical values measured within the island waterways.

TABLE 2-14

**GEOMETRIC MEAN WATER QUALITY CHARACTERISTICS
OF SURFACE WATER SAMPLES COLLECTED AT ISLAND WATERWAY
SITES FROM APRIL-SEPTEMBER 2020**

| LOCATION | PARAMETER | | | | | | | | | | | | |
|----------|----------------------|---------------------|------------------------------|---------------------------|-------------------------|-------------------|---------------|---------------------------|-------------------------|-------------------|--------------------|------------------|-------------------------|
| | Alkalinity (m/gl) | Ammonia N (µg/l) | NO _x -N (µg/l) | Diss. Organic N (µg/l) | Particulate N (µg/l) | Total N (µg/l) | SRP (µg/l) | Diss. Organic P (µg/l) | Particulate P (µg/l) | Total P (µg/l) | Turbidity (NTU) | Color (Pt-Co) | Chlorophyll-a (µg/l) |
| M-5 | 139 | 3 | 5 | 451 | 67 | 577 | 22 | 9 | 12 | 45 | 5.1 | 6 | 11.3 |
| M-6 | 136 | 9 | 6 | 451 | 93 | 573 | 28 | 4 | 11 | 45 | 2.2 | 9 | 14.8 |
| M-7 | 137 | 5 | 4 | 474 | 55 | 555 | 23 | 13 | 9 | 46 | 2.7 | 7 | 15.1 |
| M-8 | 128 | 4 | 4 | 474 | 119 | 615 | 20 | 10 | 14 | 45 | 2.3 | 9 | 14.2 |
| M-9 | 135 | 7 | 4 | 469 | 101 | 596 | 26 | 4 | 13 | 45 | 2.4 | 12 | 14.3 |
| M-10 | 133 | 4 | 4 | 446 | 89 | 584 | 21 | 15 | 9 | 46 | 1.4 | 10 | 14.4 |
| M-11 | 133 | 3 | 4 | 319 | 126 | 522 | 24 | 13 | 12 | 53 | 1.0 | 8 | 14.9 |
| M-12 | 141 | 5 | 5 | 489 | 113 | 631 | 25 | 10 | 8 | 44 | 1.3 | 13 | 15.3 |
| M-13 | 139 | 6 | 4 | 493 | 131 | 696 | 19 | 11 | 12 | 44 | 2.1 | 15 | 18.9 |
| M-14 | 135 | 4 | 7 | 563 | 116 | 700 | 20 | 4 | 12 | 39 | 2.0 | 6 | 15.5 |
| M-15 | 137 | 3 | 3 | 468 | 48 | 535 | 24 | 8 | 7 | 39 | 2.5 | 7 | 14.6 |
| M-16 | 138 | 5 | 3 | 361 | 97 | 477 | 24 | 9 | 9 | 44 | 2.2 | 6 | 12.2 |
| M-17 | 136 | 4 | 4 | 480 | 85 | 584 | 26 | 8 | 10 | 46 | 3.2 | 6 | 9.6 |

Similar to the trends observed in the off-shore surface water samples, island waterways contained an abundance of SRP which is directly available for algal uptake, and the lack of inorganic nitrogen likely limits algal productivity within the waterways. Measured total phosphorus concentrations during the field monitoring program appear to be similar to long-term historical values measured within the island waterways.

A relatively high degree of variability was observed in measured values of both turbidity and color, with turbidity values ranging from 1.0-5.1 NTU and color values ranging from 6-15 Pt-Co units. An inverse relationship appears to exist between turbidity and color, with higher turbidity values generally associated with lower color concentrations.

Measured chlorophyll-a concentrations in the island waterways appear to be somewhat higher than historical values discussed previously. The ERD Laboratory uses the highly sensitive fluorometric technique for measuring chlorophyll-a which relies upon actual chlorophyll standards rather than the common regression relationship used by most commercial laboratories. As discussed previously for the off-shore surface water samples, the monitoring program was conducted during the most biologically productive months of the year, and values collected during other seasonal periods would likely be lower in value.

2.3.3.3 Summary

Water quality monitoring conducted by ERD indicated a well mixed water column at all on- and off-shore monitoring sites within the top 4-5 m of the water column. However, areas deeper than 4-5 m, particularly in upstream portions of the canals, were characterized by anaerobic conditions with large increases in conductivity near the water-sediment interface. These conditions suggest poor circulation and relatively stagnant conditions in upstream areas. Chemical characteristics of surface water samples collected by ERD are similar to long-term historical values measured in Marco Island waterways. Waterway samples suggest an enrichment in concentrations for nutrients and chlorophyll-a, compared with off-shore waters, which increases with increasing distance upstream within the waterways. No significant differences were observed in water quality characteristics between incoming and outgoing tidal events, although concentrations of nutrients and chlorophyll-a were often higher under outgoing tidal conditions.

2.4 Sediment Characteristics

Sediment core samples were collected in off-shore and waterway sites to evaluate the characteristics of existing sediments and potential impacts on water quality within the waterways. Sediment core samples were collected at 26 locations on April 29 and May 26, 2020 by ERD personnel. Locations of Marco Island sediment sampling sites are illustrated on Figure 2-20.

2.4.1 Sampling Techniques

Sediment samples were collected at each of the 26 monitoring sites using a stainless steel split-spoon core device, which was penetrated into the sediments at each location to a minimum distance of approximately 0.5 m. After retrieval of the sediment sample, any overlying water was carefully decanted before the split-spoon device was opened to expose the collected sample. Visual characteristics of each sediment core sample were recorded, and the 0-10 cm layer was carefully sectioned off and placed into a 120-ml wide-mouth polyethylene container for transport to the ERD laboratory. Duplicate core samples were collected at each site, and the 0-10 cm layers were combined together to form a single composite sample for each of the 26 monitoring sites. The polyethylene containers utilized for storage of the collected samples were filled completely to minimize air space in the storage container above the composite sediment sample. Each of the collected samples was stored in ice and returned to the ERD laboratory for physical and chemical characterization.

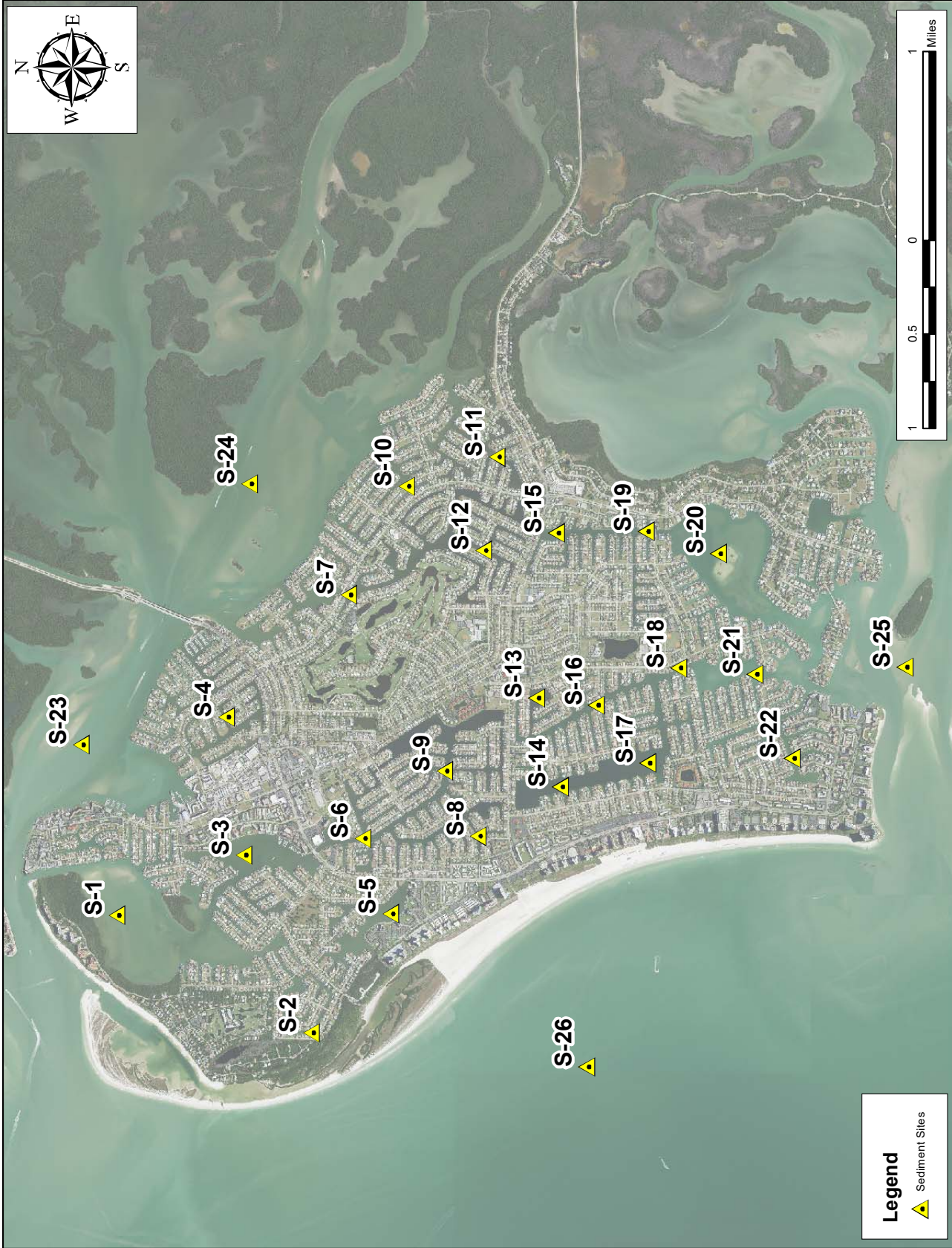

Figure 2-20. Locations of Sediment Core Monitoring Sites.

2.4.2 Sediment Characterization and Speciation Techniques

Each of the 26 collected sediment core samples was analyzed for a variety of general parameters, including moisture content, organic content, sediment density, total nitrogen, and total phosphorus. Methodologies utilized for preparation and analysis of the sediment samples for these parameters are outlined in Table 2-15.

TABLE 2-15

ANALYTICAL METHODS FOR SEDIMENT ANALYSES

| MEASUREMENT PARAMETER | SAMPLE PREPARATION | ANALYSIS REFERENCE | REFERENCE PREP./ANAL.* | METHOD DETECTION LIMITS (MDLs) |
|-----------------------------------|-------------------------------|--------------------|------------------------|--------------------------------|
| pH | EPA 9045 | EPA 9045 | 3 / 3 | 0.01 pH units |
| Moisture Content | p. 3-54 | p. 3-58 | 1 / 1 | 0.1% |
| Organic Content (Volatile Solids) | p. 3-52 | pp. 3-52 to 3-53 | 1 / 1 | 0.1% |
| Total Phosphorus | pp. 3-227 to 3-228 (Method C) | EPA 365.4 | 1 / 2 | 0.005 mg/kg |
| Total Nitrogen | p. 3-201 | pp. 3-201 to 3-204 | 1 / 1 | 0.010 mg/kg |
| Specific Gravity (Density) | p. 3-61 | pp. 3-61 to 3-62 | 1 / 1 | NA |

*REFERENCES:

1. Procedures for Handling and Chemical Analysis of Sediments and Water Samples, EPA/Corps of Engineers, EPA/CE-81-1, 1981.
2. Methods for Chemical Analysis of Water and Wastes, EPA 600/4-79-020, Revised March 1983.
3. Test Methods for Evaluating Solid Wastes, Physical-Chemical Methods, Third Edition, EPA-SW-846, Updated November 1990.

In addition to general sediment characterization, a fractionation procedure for inorganic soil phosphorus was conducted on each of the 26 collected sediment samples. A modified version of the Chang and Jackson Procedure, as proposed by Peterson and Corey (1966), was used for phosphorus fractionation. The modified Chang and Jackson Procedure allows the speciation of sediment phosphorus into saloid-bound phosphorus (defined as the sum of soluble plus easily exchangeable sediment phosphorus), iron-bound phosphorus, and aluminum-bound phosphorus. Although not used in this project, subsequent extractions of the Chang and Jackson procedure also provide calcium-bound and residual fractions.

The Chang and Jackson procedure was originally developed at the University of Wisconsin to evaluate phosphorus bonding in dried agricultural soils. However, drying of wet sediments will significantly impact phosphorus speciation, particularly the soluble and iron-bound associations. Therefore, the basic Chang and Jackson method was adapted and modified by ERD in 1992 for wet sediments by adjusting solution concentrations and extraction timing to account for the liquid volume in the wet sediments and the reduced solids mass. This modified method has been used as the basis for all sediment inactivation projects which have been conducted in the State of Florida.

Saloid-bound phosphorus is considered to be available under all conditions at all times. Iron-bound phosphorus is relatively stable under aerobic environments, generally characterized by redox potentials greater than 200 mv (E_h), while unstable under anoxic conditions, characterized by redox potential less than 200 mv. Aluminum-bound phosphorus is considered to be stable under all conditions of redox potential and natural pH conditions. A schematic of the Chang and Jackson Speciation Procedure for evaluating soil phosphorus bounding is given in Figure 2-21.

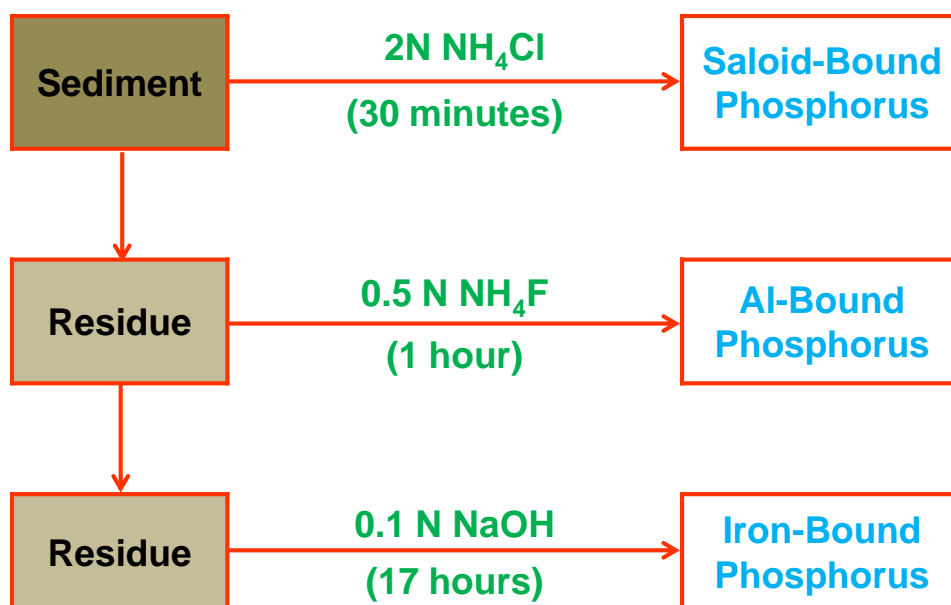

Figure 2-21. Schematic of Chang and Jackson Speciation Procedure for Evaluating Soil Phosphorus Bonding.

For purposes of evaluating release potential, ERD typically assumes that potentially available inorganic phosphorus in soils/sediments, particularly those which exhibit a significant potential to develop reduced conditions below the sediment-water interface, is represented by the sum of the soluble inorganic phosphorus and easily exchangeable phosphorus fractions (collectively termed saloid-bound phosphorus), plus iron-bound phosphorus which can become solubilized under reduced conditions. Aluminum-bound phosphorus is generally considered to be unavailable in the typical sediment pH range of approximately 5.5-7.5 under a wide range of redox conditions.

2.4.3 Sediment Characteristics

2.4.3.1 Visual Characteristics

Visual characteristics of sediment core samples were recorded for each of the 26 sediment samples collected in Marco Island during April and May 2020, and a summary of visual characteristics of sediment core samples is given in Table 2-16. In general, a thin surficial layer of gray sandy clay with shell fragments was observed at 18 of the 26 monitoring sites, with measured depths ranging from 4-116 cm. This unconsolidated surficial layer is comprised primarily of fresh organic material (such as dead algal cells) and detritus which has recently accumulated onto the bottom of the waterways combined with a mixture of sand and clay, likely residual material from the original construction. Much of this material is easily disturbed by wind action or boating activities. Sediments beneath the surficial layers consist primarily of brown medium sand combined with organic detritus and shell fragments.

2.4.3.2 General Sediment Characteristics

After return to the ERD Laboratory, the collected sediment core samples were evaluated for general sediment characteristics, including pH, moisture content, organic content, sediment density, total nitrogen, and total phosphorus. A summary of general characteristics measured in each of the 26 collected sediment core samples is given in Table 2-17. In general, sediments at Marco Island sites were found to be slightly acidic to slightly alkaline in pH, with measured pH values ranging from 6.64-7.85 and an overall geometric mean of 7.25. These values are similar to sediment pH measurements commonly observed in estuarine systems.

Measurements of sediment moisture content and organic content in Marco Island sediments were variable between the individual sediment sites. Some of the collected sediment samples are characterized by a relatively low moisture content and low organic content, suggesting that these surficial sediments are comprised primarily of sand or inorganic detritus. In contrast, other sediment core samples are characterized by elevated values for both moisture content and organic content, suggesting areas of accumulated organic muck. Measured sediment moisture contents ranged from 20.4-77.5% with an overall geometric mean of 44.1%. Sediment moisture contents in excess of 50% are often indicative of highly organic sediments, while moisture contents less than 50% reflect mixtures of sand and muck. The measured sediment moisture contents at the Marco Island sites are similar to values commonly observed in estuaries and reflect a combination of sandy and loose organic sediments.

Measured sediment organic content in Marco Island sediments ranged from 0.1-20.9%, with an overall mean of 5.2%. In general, sediment organic content values in excess of 20-30% are often indicative of organic muck type sediments, with values less than 20-30% representing either sand or mixtures of muck and sand, suggesting a low amount of organic matter in the sediments.

TABLE 2-16

**VISUAL CHARACTERISTICS OF SEDIMENT CORE SAMPLES COLLECTED
IN MARCO ISLAND WATERWAYS ON APRIL 29 AND MAY 25, 2020**

| SITE NO. | LAYER (cm) | VISUAL APPEARANCE |
|----------|------------|---|
| S-1 | 0 - 10 | Gray sandy clay with shell |
| | 10 - >24 | Brown fine sand with organics and shell |
| S-2 | 0 - 36 | Gray sandy clay with shell |
| | 36 - >43 | Brown fine sand with organics and shell |
| S-3 | 0 - >42 | Gray sandy clay with shell |
| S-4 | 0 - 22 | Gray sandy clay with shell |
| | 22 - 32 | Black fine sand |
| | 32 - 33 | Brown fine sand |
| | 33 - 35 | Black fine sand |
| | 35 - >38 | Brown fine sand |
| S-5 | 0 - >66 | Gray sandy clay with shell |
| S-6 | 0 - >15 | Gray sandy clay with shell |
| S-7 | 0 - 4 | Gray sandy clay with shell |
| | 4 - >18 | Brown fine sand with organics |
| S-8 | 0 - >23 | Brown fine sand with organics |
| S-9 | 0 - 50 | Gray sandy clay with shell |
| | 50 - >62 | Brown fine sand with organics |
| S-10 | 0 - 8 | Gray sandy clay with shell |
| | 8 - 66 | Dark brown consolidated organic muck |
| | 66 - >83 | Brown fine sand with organics and shell |
| S-11 | 0 - >63 | Gray sandy clay with shell |
| S-12 | 0 - 29 | Gray sandy clay with shell |
| | 29 - >38 | Fine brown sand |
| S-13 | 0 - 41 | Gray sandy clay with shell |
| | 41 - >44 | Brown fine sand with organics |
| S-14 | 0 - 33 | Gray sandy clay with shell |
| | 33 - >71 | Brown fine sand with organics |
| S-15 | 0 - 41 | Gray sandy clay with shell |
| | 41 - 52 | Brown organic detritus |
| | 52 - 86 | Gray sandy clay with shell |
| | 85 - >97 | Brown organic detritus |
| S-16 | 0 - 8 | Gray sandy clay |
| | 8 - >24 | Brown fine sand with organics |
| S-17 | 0 - 4 | Dark brown unconsolidated organic muck |
| | 4 - >35 | Brown fine sand with organics |
| S-18 | 0 - >20 | Gray sand with shell |
| S-19 | 0 - 4 | Dark brown unconsolidated organic muck |
| | 4 - > 35 | Brown fine sand with organics |
| S-20 | 0 - >116 | Clay Gray sandy clay with shell |
| S-21 | 0 - 28 | Gray sandy clay with shell |
| | 28 - >34 | Brown fine sand with organics |
| S-22 | 0 - 102 | Gray sandy clay with shell |
| | 102 - >111 | Brown fine sand with organics |
| S-23 | 0 - >6 | Brown fine sand with organics and shell |
| S-24 | 0 - >29 | Brown fine sand with organics |
| S-25 | 0 - >10 | Brown fine sand with organics and shell |
| S-26 | 0 - >30 | Light gray fine sand |

TABLE 2-17
GENERAL CHARACTERISTICS OF SEDIMENT CORE
SAMPLES COLLECTED IN MARCO ISLAND DURING 2020

| SITE | DATE COLLECTED | pH (s.u.) | MOISTURE CONTENT (%) | ORGANIC CONTENT (%) | WET DENSITY (g/cm ³) | TOTAL NITROGEN (µg/cm ³) | TOTAL PHOSPHORUS (µg/cm ³) |
|------------------------|----------------|-------------|----------------------|---------------------|----------------------------------|--------------------------------------|--|
| S-1 | 4/29/20 | 7.37 | 33.7 | 6.4 | 1.93 | 418 | 390 |
| S-2 | 4/29/20 | 7.48 | 54.2 | 9.9 | 1.62 | 509 | 550 |
| S-3 | 4/29/20 | 7.27 | 25.3 | 5.3 | 2.06 | 398 | 333 |
| S-4 | 4/29/20 | 7.48 | 54.0 | 8.9 | 1.63 | 536 | 454 |
| S-5 | 5/26/20 | 6.69 | 67.9 | 14.8 | 1.41 | 567 | 536 |
| S-6 | 4/29/20 | 7.40 | 28.7 | 3.1 | 2.04 | 506 | 471 |
| S-7 | 4/29/20 | 7.39 | 29.5 | 3.8 | 2.02 | 787 | 422 |
| S-8 | 4/29/20 | 7.44 | 34.2 | 4.3 | 1.94 | 646 | 376 |
| S-9 | 4/29/20 | 7.46 | 65.2 | 13.9 | 1.45 | 509 | 589 |
| S-10 | 4/29/20 | 7.36 | 64.3 | 12.5 | 1.47 | 630 | 455 |
| S-11 | 4/29/20 | 7.25 | 73.0 | 20.9 | 1.32 | 281 | 251 |
| S-12 | 4/29/20 | 7.46 | 71.0 | 17.5 | 1.36 | 597 | 412 |
| S-13 | 4/29/20 | 7.21 | 76.4 | 7.5 | 1.33 | 282 | 334 |
| S-14 | 4/29/20 | 7.15 | 75.2 | 15.4 | 1.32 | 610 | 538 |
| S-15 | 4/29/20 | 7.38 | 77.5 | 0.1 | 1.34 | 397 | 537 |
| S-16 | 4/29/20 | 7.00 | 28.8 | 5.8 | 2.01 | 704 | 870 |
| S-17 | 4/29/20 | 7.10 | 72.1 | 13.0 | 1.36 | 519 | 544 |
| S-18 | 5/26/20 | 6.64 | 25.1 | 0.9 | 2.11 | 154 | 77 |
| S-19 | 4/29/20 | 7.18 | 36.3 | 3.2 | 1.93 | 443 | 500 |
| S-20 | 4/29/20 | 7.06 | 72.8 | 19.4 | 1.33 | 517 | 542 |
| S-21 | 4/29/20 | 7.10 | 45.9 | 4.8 | 1.77 | 1234 | 448 |
| S-22 | 4/29/20 | 7.02 | 70.5 | 17.1 | 1.37 | 642 | 625 |
| S-23 | 4/29/20 | 7.85 | 21.5 | 1.2 | 2.16 | 425 | 193 |
| S-24 | 4/29/20 | 7.36 | 28.3 | 3.2 | 2.04 | 829 | 539 |
| S-25 | 4/29/20 | 7.19 | 21.4 | 1.7 | 2.16 | 405 | 345 |
| S-26 | 11/20/20 | 7.44 | 20.4 | 0.9 | 2.45 | 88 | 233 |
| Minimum Value: | | 6.64 | 20.4 | 0.1 | 1.32 | 88 | 77 |
| Maximum Value: | | 7.85 | 77.5 | 20.9 | 2.45 | 1,234 | 870 |
| Geometric Mean: | | 7.25 | 44.1 | 5.2 | 1.69 | 471 | 409 |

Measured sediment density values are also useful in evaluating the general physical characteristics of sediments within a lake. Sediments with calculated wet densities between 1.0 g/cm³ and 1.25 g/cm³ are indicative of highly organic muck type sediments, while sediment densities of approximately 2.0 or greater are indicative of sandy sediment conditions. Values between 1.25 g/cm³ and 2.0 g/cm³ indicate mixtures of sand muck. Measured sediment density values in Marco Island sediments range from 1.32-2.45 g/cm³, with an overall mean of 1.69 g/cm³, indicating sediments which are comprised primarily of sandy clay and sand with a low organic fraction.

Measured concentrations of total phosphorus in Marco Island sediments were found to be low to elevated in value with a moderate degree of variability throughout the sites, ranging from 77-870 µg/cm³, with an overall mean of 409 µg/cm³. In general, sandy sediments with high wet densities are characterized by low total phosphorus concentrations, while highly organic muck type sediments are characterized by elevated total phosphorus concentrations.

Similar to the trends observed for sediment phosphorus concentrations, total nitrogen concentrations are low in value, with a low degree of variability throughout Marco Island sediments. Measured sediment nitrogen concentrations ranged from 88-1,234 µg/cm³, with an overall mean of 471 µg/cm³. Measured sediment nitrogen concentrations appear to be similar to values normally observed in estuary systems.

2.4.3.3 Phosphorus Speciation

As discussed in Section 2.4.3, each of the collected sediment core samples was evaluated for phosphorus speciation based upon the Chang and Jackson speciation procedure. This procedure allows phosphorus within the sediments to be speciated with respect to bonding mechanisms within the sediments and is useful in evaluating the stability of phosphorus in the sediments and the potential for release of phosphorus from the sediments under anoxic or other conditions.

A summary of phosphorus speciation in sediment core samples collected from Marco Island sites during 2020 is given in Table 2-18. Saloid-bound phosphorus represents sediment phosphorus which is either soluble or easily exchangeable and is typically considered to be readily available for release from the sediments into the overlying water column. As seen in Table 2-18, saloid-bound phosphorus concentrations appear to be low in value at most of the monitoring sites. Measured values for saloid-bound phosphorus range from 2-26 µg/cm³, with an overall geometric mean of 8 µg/cm³, representing a moderate pool of readily available phosphorus.

TABLE 2-18

**PHOSPHORUS SPECIATION IN SEDIMENT CORE SAMPLES
COLLECTED AT MARCO ISLAND DURING APRIL AND MAY 2020**

| SITE | DATE COLLECTED | SALOID-BOUND P ($\mu\text{g}/\text{cm}^3$ wet wt.) | IRON-BOUND P ($\mu\text{g}/\text{cm}^3$ wet wt.) | ALUMINUM-BOUND P ($\mu\text{g}/\text{cm}^3$ wet wt.) | AVAILABLE SEDIMENT PHOSPHORUS | |
|------------------------|----------------|--|--|--|-------------------------------|--------------|
| | | | | | g/cm^3 | % of Total P |
| S-1 | 4/29/20 | 10 | 5 | 106 | 16 | 4 |
| S-2 | 4/29/20 | 9 | 6 | 96 | 16 | 3 |
| S-3 | 4/29/20 | 15 | 8 | 94 | 23 | 7 |
| S-4 | 4/29/20 | 7 | 19 | 63 | 26 | 6 |
| S-5 | 5/26/20 | 6 | 4 | 140 | 10 | 2 |
| S-6 | 4/29/20 | 7 | 7 | 94 | 14 | 3 |
| S-7 | 4/29/20 | 21 | 10 | 102 | 31 | 7 |
| S-8 | 4/29/20 | 7 | 9 | 76 | 16 | 4 |
| S-9 | 4/29/20 | 3 | 8 | 64 | 11 | 2 |
| S-10 | 4/29/20 | 5 | 11 | 90 | 17 | 4 |
| S-11 | 4/29/20 | 9 | 12 | 90 | 21 | 8 |
| S-12 | 4/29/20 | 5 | 8 | 93 | 12 | 3 |
| S-13 | 4/29/20 | 3 | 6 | 64 | 9 | 3 |
| S-14 | 4/29/20 | 8 | 8 | 78 | 16 | 3 |
| S-15 | 4/29/20 | 3 | 5 | 59 | 8 | 1 |
| S-16 | 4/29/20 | 21 | 7 | 104 | 28 | 3 |
| S-17 | 4/29/20 | 4 | 6 | 68 | 10 | 2 |
| S-18 | 5/26/20 | 9 | 2 | 18 | 11 | 14 |
| S-19 | 4/29/20 | 10 | 8 | 96 | 18 | 4 |
| S-20 | 4/29/20 | 11 | 4 | 72 | 15 | 3 |
| S-21 | 4/29/20 | 12 | 4 | 77 | 16 | 4 |
| S-22 | 4/29/20 | 7 | 5 | 81 | 12 | 2 |
| S-23 | 4/29/20 | 26 | 5 | 37 | 31 | 16 |
| S-24 | 4/29/20 | 17 | 12 | 98 | 30 | 6 |
| S-25 | 4/29/20 | 25 | 2 | 42 | 26 | 8 |
| S-26 | 11/20/20 | 2 | 2 | 22 | 5 | 2 |
| Minimum Value: | | 2 | 2 | 18 | 5 | 1 |
| Maximum Value: | | 26 | 19 | 140 | 31 | 16 |
| Geometric Mean: | | 8 | 6 | 72 | 16 | 4 |

In general, iron-bound phosphorus associations in the Marco Island sediments appear to be low in value. Iron-bound phosphorus is relatively stable under oxidized conditions, but becomes unstable under a reduced environment, causing the iron-phosphorus bonds to separate, releasing the bound phosphorus directly into the water column. Iron-bound phosphorus concentrations in the Marco Island sediments range from 2-19 $\mu\text{g}/\text{cm}^3$, with an overall mean of 6 $\mu\text{g}/\text{cm}^3$. Since iron-bound phosphorus can be released under anoxic conditions, portions of the sediments may have conditions favorable for release of iron-bound sediment phosphorus into the water column throughout much of the year. However, the iron-bound phosphorus concentrations summarized in Table 2-18 appear to be low in value compared with values commonly observed in estuary systems.

Aluminum-bound phosphorus represents an unavailable species of phosphorus within the sediments. Phosphorus bound with aluminum is typically considered to be inert under a wide range of pH and redox conditions within the sediments. Aluminum-bound sediment phosphorus concentrations at the Marco Island sites range from 18-140 $\mu\text{g}/\text{cm}^3$, with an overall mean of 75 $\mu\text{g}/\text{cm}^3$. These values suggest that approximately 13% of the existing phosphorus within the sediments is bound in sediment associations with aluminum which are considered to be unavailable.

Total available phosphorus represents the sum of the saloid-bound phosphorus and iron-bound phosphorus associations in each sediment core sample. Since the saloid-bound phosphorus is immediately available, and the iron-bound phosphorus is available under reduced conditions, the sum of these speciations represents the total phosphorus which is potentially available from inorganic bonding mechanisms within the sediments. This information can be utilized as a guide for future sediment management activities such as dredging. A summary of total available phosphorus in each of the 26 collected sediment core samples is also given in Table 2-18. Total available phosphorus concentrations within the sediments range from 5-31 $\mu\text{g}/\text{cm}^3$, with an overall geometric mean of 16 $\mu\text{g}/\text{cm}^3$, reflecting a low value.

Available sediment phosphorus can also be expressed as a percentage of total phosphorus concentrations within the sediments to indicate the percentage of existing sediment phosphorus which is available for release. This value is calculated as the ratio of the total available phosphorus values listed for each site in Table 2-18 divided by the total sediment phosphorus concentrations listed in Table 2-17. The percentage of available phosphorus within the Marco Island sediments ranges from approximately 1-16%, with an overall geometric mean of 4%. This suggests that approximately 4% of the existing accumulation of phosphorus within the sediments is potentially available for release into the overlying water column as a result of sediment agitation or anoxic conditions. Since the existing sediment phosphorus concentrations are low in value, only a small amount of sediment phosphorus is potentially available for release.

2.4.3.4 Comparison of Sediment Characteristics

A comparison of sediment characteristics by sub-basins and off-island areas is given in Table 2-19. Measured sediment values for pH and moisture content are relatively similar between collection sites in each of the 5 sub-basin areas. Measured organic content in sediments collected in Sub-basins 1, 2, and 4 appear to be similar in value, with the most elevated sediment organic content observed in Sub-basin 3 and the lowest sediment organic content observed in Sub-basin 5. In contrast, off-island sediment monitoring sites appear to have substantially lower values for moisture content and organic content, along with a much greater value for wet density, indicating a sandy sediment substrate. These values suggest that sediments in the off-shore monitoring sites consist primarily of sand with low moisture and organic content, reflecting a low level of accumulation for organic matter. The off-island and Gulf monitoring sites receive significantly more flushing activity than the internal waterways where stagnant conditions are often observed.

TABLE 2-19

COMPARISON OF SEDIMENT CHARACTERISTICS BY SUB-BASIN AND OFF-ISLAND AREAS

| SUB-BASIN | SITES INCLUDED | pH (s.u.) | MOISTURE CONTENT (%) | ORGANIC CONTENT (%) | WET DENSITY (g/cm ³) | TOTAL NITROGEN (µg/cm ³) | TOTAL PHOSPHORUS (µg/cm ³) | SEDIMENT PHOSPHORUS SPECIATION (µg/cm ³) | | | AVAILABLE SEDIMENT PHOSPHORUS | |
|----------------|----------------------|-----------|----------------------|---------------------|----------------------------------|--------------------------------------|--|--|------------|----------------|-------------------------------|--------------|
| | | | | | | | | Saloid-Bound | Iron-Bound | Aluminum-Bound | g/cm ³ | % of Total P |
| 1 | 1,2,3,5,6,8,9 | 7.30 | 41.2 | 7.1 | 1.76 | 502 | 454 | 7 | 7 | 93 | 15 | 3 |
| 2 | 4 | 7.48 | 54.0 | 8.9 | 1.63 | 536 | 454 | 7 | 19 | 63 | 26 | 6 |
| 3 | 7,10,11,12 | 7.36 | 56.0 | 11.5 | 1.52 | 537 | 376 | 8 | 10 | 94 | 19 | 5 |
| 4 | 13,14,16,17,18,21,22 | 7.03 | 51.6 | 6.8 | 1.58 | 499 | 407 | 8 | 5 | 63 | 14 | 3 |
| 5 | 15,19,20 | 7.21 | 58.9 | 0.6 | 1.51 | 450 | 526 | 7 | 6 | 74 | 13 | 2 |
| Off-Island | 23,24,25 | 7.46 | 23.5 | 1.9 | 2.12 | 523 | 330 | 22 | 4 | 53 | 5 | 2 |
| Gulf of Mexico | 26 | 7.44 | 20.4 | 0.9 | 2.45 | 88 | 233 | 2 | 2 | 22 | 21 | 9 |

Measured sediment nitrogen concentrations are virtually identical in each of the 5 sub-basins as well as the off-island monitoring sites, suggesting no significant differences in nitrogen concentrations between any of the sediment monitoring locations. Since nitrogen appears to be the limiting nutrient in both on-island and off-shore areas, the lack of differential accumulation of organic nitrogen is not surprising and indicates that organic nitrogen is rapidly recycled back into the water column which limits sediment nitrogen accumulation.

A somewhat higher degree of variability is apparent in measured total phosphorus concentrations between the sub-basins and off-island monitoring sites, although geometric mean values for the sub-basin areas are relatively similar. Somewhat lower overall total phosphorus concentrations of $330 \mu\text{g}/\text{cm}^3$ and $233 \mu\text{g}/\text{cm}^3$ were observed at the off-island and Gulf monitoring sites where accumulation of organic matter is limited due to the relatively constant flow regimes. It appears that phosphorus is accumulating within the sediments of the island waterways since water column concentrations do not appear to be limiting algal productivity. This reduced uptake of phosphorus allows phosphorus to accumulate in sediments.

The off-island monitoring sites appear to have a higher concentration of saloid-bound phosphorus and a lower concentration of iron-bound phosphorus compared with the on-island waterways and Gulf monitoring sites. More elevated levels of saloid-bound and lower levels of iron-bound are common in primarily sand sediments where phosphorus bonding mechanisms are much less complex than those which occur in sediments with significant organic content. Concentrations of aluminum-bound and organic-bound phosphorus associations appear to be similar between each of the 5 sub-basin areas, with lower values for each of these parameters observed in the off-island sites. These lower values are also associated with the lack of significant organic matter at the off-island sites.

2.4.3.5 Summary

Overall, sediment samples collected in Marco Island waterways are near neutral in pH, with relatively low levels for both moisture content and organic content, suggesting sediments consisting primarily of sand or inert materials. Measured values for moisture content and organic content are lower in off-shore sediments than in island waterways, reflecting differences in sediment accumulation mechanisms between the 2 areas. No significant differences are apparent in accumulation of total nitrogen between the island waterways and off-shore sites, presumably resulting from nitrogen limitation within the aquatic systems, although an extremely low nitrogen concentration was measured at the Gulf site. However, accumulation of total phosphorus is apparent in Marco Island waterways compared with off-shore and Gulf sites. On-shore and off-shore sites exhibit low to moderate levels of both saloid- and iron-bound sediment phosphorus. Overall, approximately 9% of the total phosphorus present within the sediments is potentially available for release into the overlying water column.

SECTION 3

CHARACTERISTICS OF THE MARCO ISLAND DRAINAGE BASIN

Characteristics of the drainage basin area for Marco Island are summarized in this section, including information on drainage basin delineations, land use characteristics, soil types, basin topography, hydrologic characteristics, stormwater treatment facilities and techniques, and methods of sewage disposal. A discussion of current watershed characteristics is given in the following sections. For purposes of this analysis, “current” conditions are defined as those present in June 2020.

For purposes of this project, the drainage basin includes all developed areas located within the City of Marco Island. The City boundary includes not only the main island area but also areas of largely undeveloped small keys and mangrove forests located east and southeast of the main island and a sparsely developed area on Horr’s Island, referred to as Key Marco PUD. Since these areas are mostly undeveloped and were not included in the water quality evaluation program, they are excluded for purposes of this analysis.

3.1 Watershed Characteristics

A delineation of contributing drainage basin areas for Marco Island was conducted by ERD as part of this project. A preliminary drainage basin map for Marco Island was obtained from the Marco Island Public Works Department as a stormsewer inventory map with drainage basin delineations. ERD also obtained 1-ft LIDAR contour elevations for the watershed area (dated 2018) obtained from USGS. In addition to the information obtained from Marco Island and USGS, ERD also reviewed high-resolution aerial photography (January 2018) for the drainage basin area and conducted extensive field reconnaissance. This information was used to verify and modify, as appropriate, the watershed delineation contained in the Marco Island GIS system to reflect existing conditions at the time of this analysis during 2020.

An overview of the delineated drainage basins for Marco Island is given on Figure 3-1. For purposes of this evaluation, the Marco Island area has been divided into 7 separate drainage sub-basins. The main island is divided into 5 sections, referred to as Sub-basins 1-5, which are bisected in an east-west direction by San Marco Road and in a north-south direction by Bald Eagle Drive and S. Heathwood Drive, although the north-south separation is not as definitive as the east-west separation. The northeast section is further sub-divided into areas which discharge to Factory Bay and areas which discharge to Marco Bay. Each of the 5 sub-basins discharges through the respective canal systems to open tidal water. Sub-basin 1 discharges to Collier Bay and Marco Bay. Sub-basin 2 discharge to Factory Bay and ultimately to Marco Bay, with Sub-basin 3 discharging to East Marco Bay, Sub-basin 4 discharging to Caxambas Bay, and Sub-basin 5 discharging to Roberts Bay and ultimately to Caxambas Bay.

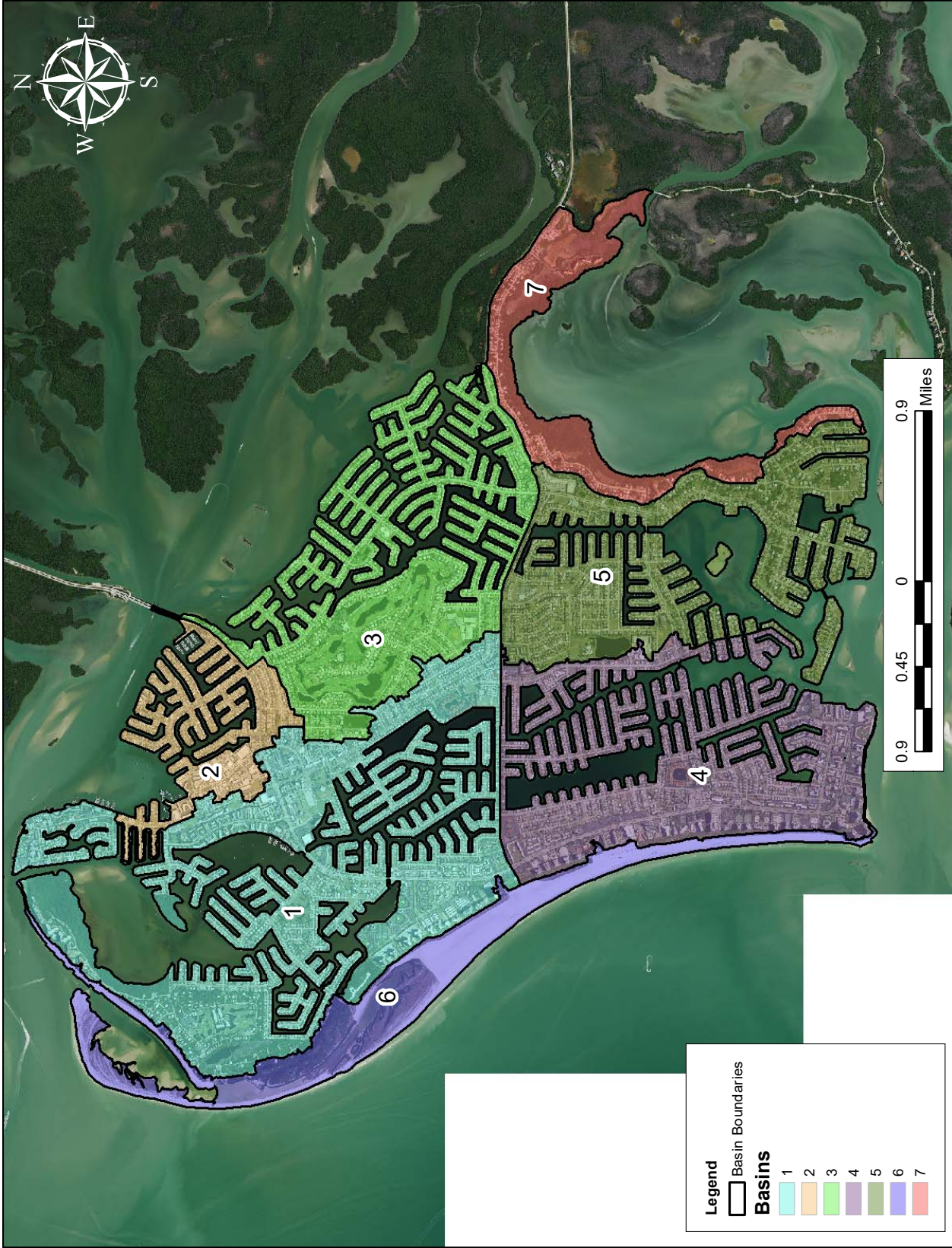

Figure 3-1. Overview of the Marco Island Drainage Basin Area.
(Photo Date: January 2018)

Two additional sub-basin areas are also included on Figure 3-1. Sub-basin 6 reflects portions of the island which discharge directly to open water by direct overland flow and primarily include the beach areas along the west side of the island. The final area, referred to as Sub-basin 7, reflects developed areas which discharge directly to Barfield Bay on the southeast side of the island, excluding Harris Island and other small keys.

A comparison of Marco Island sub-basin areas is given in Table 3-1. The identified sub-basin areas range in size from 306.5 acres (Sub-basin 2) to 1,487.1 acres (Sub-basin 1), with a total land area of 5,366.68 acres. The 5 mainland island sub-basin areas (Sub-basins 1-5) contain 84.2% of the overall drainage basin area. Each of the 2 remaining sub-basin areas contributes approximately 10% or less of the total basin area.

TABLE 3-1
SUB-BASIN AREAS DISCHARGING TO MARCO ISLAND

| SUB-BASIN | AREA (acres) | PERCENT OF TOTAL (%) | ULTIMATE POINT OF DISCHARGE |
|---------------|-----------------|----------------------|-----------------------------|
| 1 | 1,487.05 | 27.7 | Collier Bay to Marco Bay |
| 2 | 306.51 | 5.7 | Factory Bay to Marco Bay |
| 3 | 935.45 | 17.4 | East Marco Bay |
| 4 | 955.10 | 17.8 | Caxambas Bay |
| 5 | 834.67 | 15.6 | Roberts Bay to Caxambas Bay |
| 6 | 497.82 | 9.3 | Gulf of Mexico |
| 7 | 350.08 | 6.5 | Barfield Bay |
| TOTAL: | 5,366.68 | 100 | |

3.2 Land Use in the Marco Island Drainage Basin

Preliminary land use information for Marco Island was obtained from the 2016 Land Use Inventory conducted by the South Florida Water Management District (SFWMD). The Land Use Inventory is the standard resource used by FDEP and engineers throughout Florida for calculating runoff loadings and for developing TMDL documents and analyses. These data provide a uniform methodology for defining land use throughout Florida which is independent of, and in some cases different from, local land use definitions.

The land use information for the Marco Island watershed was obtained in a GIS format in the form of Level III FLUCCS (Florida Land Use Cover and Classification System) codes. The Level III FLUCCS codes were condensed by ERD to a series of general land use categories to simplify presentation of the information and to assist in assigning runoff characteristics for non-monitored land use types. The SFWMD inventory was used as a preliminary base map, and modifications to the land use characterization data were made, as necessary, using a combination of recent high resolution aerial photography and extensive field reconnaissance to reflect land use under current conditions, defined as June 2020 for purposes of this analysis. Information was also obtained from the Collier County Property Appraiser's Office to identify vacant parcels and right-of-way areas.

An overview of current land use (June 2020) in the Marco Island drainage basin is given on Figure 3-2. Under current conditions, the drainage basin is dominated primarily by medium-density residential, multi-family, commercial, recreational, and highway land uses. In addition to the developed land use categories listed previously, the Marco Island drainage basin also includes open spaces, forests, wetlands, and fresh and saltwater ponds.

A tabular summary of current land use in the Marco Island drainage basin is given in Table 3-2 which includes a land use summary for each of the sub-basin areas identified on Figure 3-1. Overall, the single largest land use category in the Marco Island drainage basin is medium-density residential which covers approximately 57.9% of the total drainage basin area. The second most significant land use category is multi-family residential (apartments, condos, etc.) which occupies 10.8% of the overall drainage basin area, followed by commercial (6.2%), mangrove swamp (5.5%), swimming beaches (5.3%), and recreational areas (3.7%). Each of the remaining land use categories contributes approximately 3% or less of the overall drainage basin area. The areas designated as Sub-basins 6 and 7 consist primarily of swimming beaches and natural coastal areas, with scattered residential homes.

3.3 Area Waterways

In addition to the land use summarized in Table 3-2, Sub-basins 1-5 also include large areas of canals and waterways which are intertwined with the developed areas, and these canals and waterways are perhaps the defining feature of Marco Island. Waterway areas are highlighted in **dark blue** on Figure 3-2 but are not included in the land use areas summarized on Table 3-2 since they are considered receiving waters for the upland areas. A summary of surface areas for waterways contained in Sub-basins 1-5 is given in Table 3-3 based on the waterway boundaries shown on Figure 3-2. Overall, the primary sub-basins contain 1,524.96 acres of canals and waterways. This information is used in a subsequent section to evaluate direct loadings from bulk precipitation on canals and waterways.

Virtually all of the canals and waterways are excavated channels which are retained by seawalls constructed of pile-driven sheets of steel, aluminum or concrete sections. Locations of existing seawalls are indicated on Figure 3-3. Overall, the canal system for Marco Island contains approximately 120 miles of constructed seawalls. Efforts for repair or replacement of existing seawalls were commonly observed during the field monitoring program.

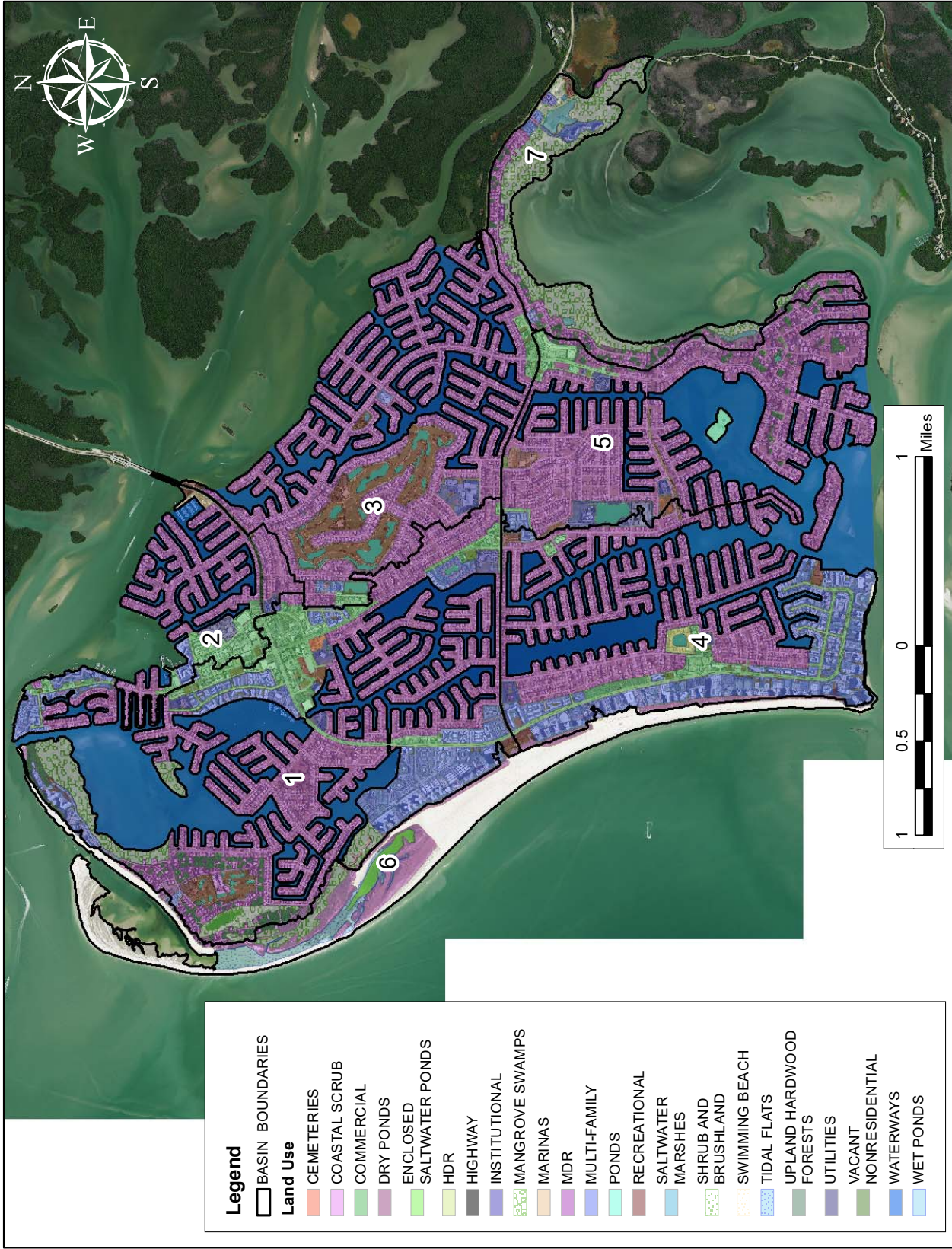

Figure 3-2. Current (June 2020) Land Use in the Marco Island Drainage Basin.

TABLE 3-2

**CURRENT (JUNE 2020) LAND USE CHARACTERISTICS
IN THE MARCO ISLAND WATERSHED**

| LAND USE | LAND USE AREA BY SUB-BASIN (acres) | | | | | | | GRANT TOTAL (acres) | PERCENT OF TOTAL (%) |
|----------------------------------|---------------------------------------|---------------|---------------|---------------|---------------|---------------|---------------|---------------------------|----------------------------|
| | 1 | 2 | 3 | 4 | 5 | 6 | 7 | | |
| Cemeteries | 3.27 | -- | -- | -- | -- | -- | -- | 3.27 | 0.1 |
| Coastal Scrub | 14.38 | -- | -- | 19.80 | 1.64 | 114.22 | 4.59 | 154.62 | 2.9 |
| Commercial | 159.93 | 49.84 | 19.90 | 74.87 | 27.60 | -- | 0.41 | 332.56 | 6.2 |
| Dry Ponds | 5.71 | 0.34 | 1.55 | 10.06 | 0.55 | -- | 0.32 | 18.52 | 0.3 |
| Saltwater Ponds | 5.57 | -- | -- | -- | -- | 17.79 | -- | 23.35 | 0.4 |
| High-Density Residential (HDR) | -- | -- | -- | 9.68 | -- | -- | -- | 9.68 | 0.2 |
| Highway | -- | 9.11 | 3.59 | -- | -- | -- | -- | 12.70 | 0.2 |
| Institutional | 25.12 | 2.97 | 22.85 | 11.21 | 24.31 | -- | 2.82 | 89.29 | 1.7 |
| Mangrove Swamps | 103.17 | -- | 1.13 | -- | -- | 22.20 | 169.06 | 295.54 | 5.5 |
| Marinas | -- | 4.72 | -- | -- | -- | -- | -- | 4.72 | 0.1 |
| Medium-Density Residential (MDR) | 815.36 | 214.18 | 714.33 | 541.67 | 706.02 | 8.17 | 106.24 | 3,105.97 | 57.9 |
| Multi-Family | 263.17 | 10.28 | 6.37 | 264.00 | 8.39 | 9.10 | 18.31 | 579.63 | 10.8 |
| Ponds | 6.35 | -- | 37.76 | 2.67 | 19.50 | -- | -- | 66.28 | 1.2 |
| Recreational | 37.28 | 1.46 | 124.81 | 14.22 | 16.98 | 1.54 | 2.84 | 199.14 | 3.7 |
| Saltwater Marshes | -- | -- | -- | -- | -- | -- | 14.37 | 14.37 | 0.3 |
| Scrub and Brushland | -- | -- | -- | -- | -- | -- | 12.17 | 12.17 | 0.2 |
| Swimming Beaches | 0.23 | -- | -- | 1.25 | -- | 281.49 | -- | 282.97 | 5.3 |
| Tidal Flats | -- | -- | -- | -- | -- | 41.66 | -- | 41.66 | 0.8 |
| Upland Hardwood Forests | 40.38 | -- | 0.26 | -- | 21.39 | 1.66 | 18.59 | 82.29 | 1.5 |
| Utilities | -- | 12.76 | -- | 3.41 | 6.67 | -- | -- | 22.83 | 0.4 |
| Vacant Lots | 7.14 | 0.85 | 2.30 | 2.27 | 1.61 | -- | -- | 14.16 | 0.3 |
| Wet Ponds | -- | -- | 0.60 | -- | -- | -- | 0.36 | 0.97 | 0.02 |
| TOTAL: | 1,487.05 | 306.51 | 935.45 | 955.10 | 834.67 | 497.82 | 350.08 | 5,366.68 | 100.0 |

TABLE 3-3

**SURFACE AREAS OF CANALS AND WATERWAYS IN
THE PRIMARY MARCO ISLAND SUB-BASINS**

| SUB-BASIN | AREA OF CANALS / WATERWAYS (acres) |
|---------------|---------------------------------------|
| 1 | 565.51 |
| 2 | 75.65 |
| 3 | 227.87 |
| 4 | 374.28 |
| 5 | 281.65 |
| TOTAL: | 1,524.96 |



Figure 3-3. Locations of Marco Island Seawalls.
(Source: City of Marco Island Public Works Department)

3.4 Soil Characteristics

Information on soil types within the Marco Island drainage basin was obtained from the SFWMD GIS database. Soil information was extracted in the form of Hydrologic Soil Groups (HSG) which classify soil types with respect to runoff-producing characteristics. The chief consideration in each of the soil group types is the inherent capacity of bare soil to permit infiltration. A summary of the characteristics of hydrologic soil groups present in the Marco Island drainage basin is given in Table 3-4.

TABLE 3-4
CHARACTERISTICS OF SCS HYDROLOGIC
SOIL GROUP CLASSIFICATIONS

| SOIL GROUP | DESCRIPTION | RUNOFF POTENTIAL | INFILTRATION RATE |
|------------|--|---|---|
| A | Deep sandy soils | Very low | High |
| A / D | Deep sandy soils with high water table in undeveloped conditions | Very high in undeveloped condition | Very low in undeveloped state |
| | | Very low when developed and water table lowered | Very high when water table lowered with development |
| D | Fine silty sands and clays | High in undeveloped condition | Very low in undeveloped state |
| | | Very high | Low to none |
| W | Wetland or hydric soils | Very high | Low to none |

A graphical summary of hydrologic soil groups (HSG) in the Marco Island drainage basin under existing conditions is given on Figure 3-4. The drainage basin is dominated by soils in HSG A and A/D, both of which reflect soils with a low runoff potential under developed conditions, with the A/D soils indicating soils which behave as HSG D under undeveloped conditions but function as HSG A soils when developed and the water table is lowered. Since the watershed is currently developed, most of the soils function as HSG A soils which exhibit a very low runoff potential and a high rate of infiltration of runoff into groundwater. HSG D and W soils are located primarily in natural low-lying areas.

A tabular summary of hydrologic soils in the Marco Island drainage basin under existing conditions is given in Table 3-5. Approximately 88.9% of the soils within the drainage basin are classified in HSG A which reflects deep sandy soils with a low runoff potential and a high infiltration rate. An additional 2.9% of the soils within the basin, primarily in perimeter areas along the western watershed boundary and southeast of Marco Island, have a dual classification of A/D which consists of deep sandy soils with a high water table in the undeveloped condition. In the undeveloped state, the soils act hydrologically as HSG D soils with a high runoff potential but function similar to an HSG A soil when the area is developed and the high water table conditions are controlled and lowered. Since much of the existing watershed has been developed

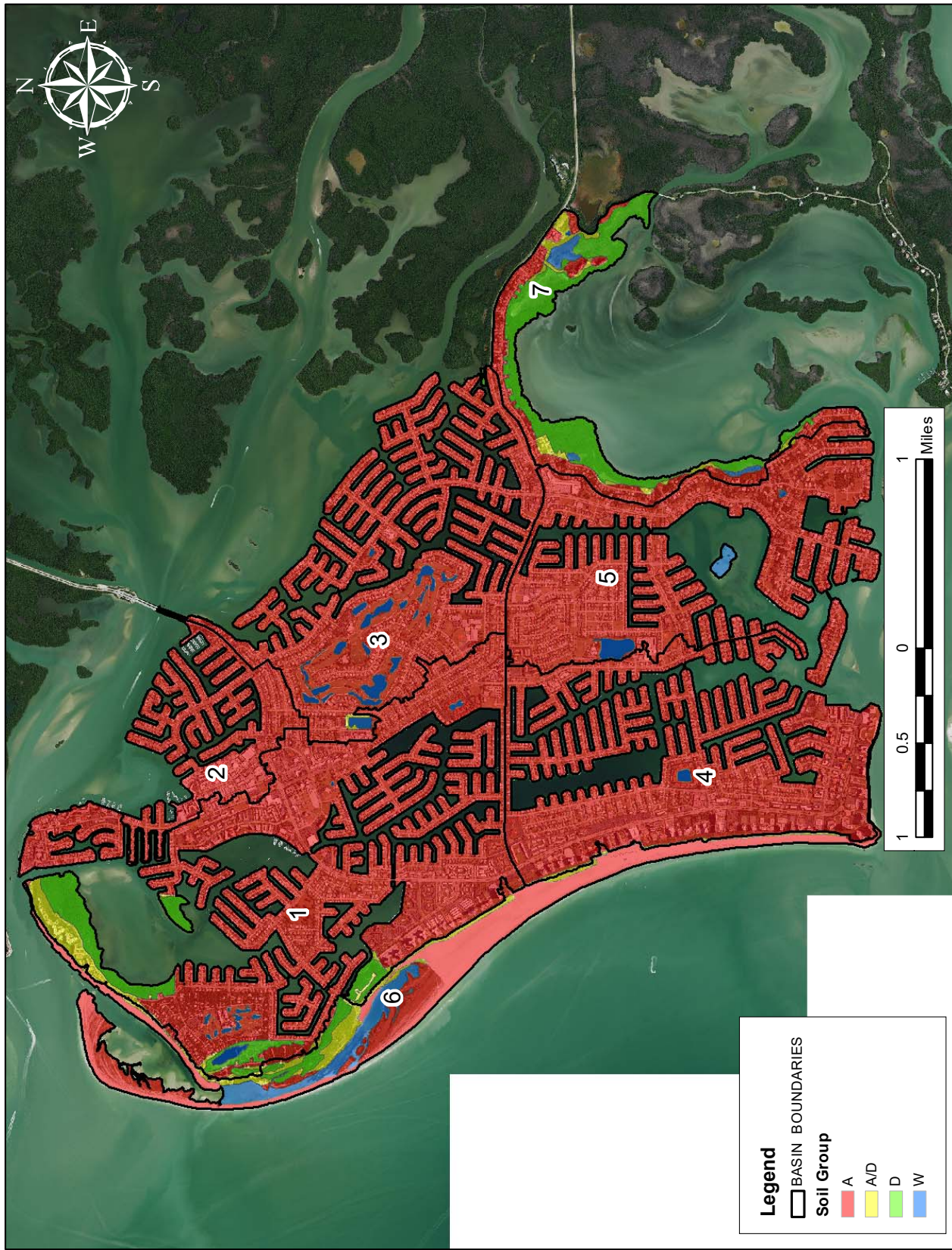

Figure 3-4. Hydrologic Soil Groups (HSG) in the Marco Island Drainage Basin.

and water control mechanisms have been initiated, 91.8% of the drainage basin area can be considered to function as an HSG A soil which exhibits a low runoff potential and a high rate of infiltration into groundwater. Approximately 5.5% of the drainage area is covered by HSG D soils in coastal perimeter areas which have a low infiltration rate and high runoff potential, and 2.7% of the drainage basin area is covered by HSG W soils which consist of wetland, ponds, and hydric soils.

TABLE 3-5

HYDROLOGIC SOIL GROUPS IN THE MARCO ISLAND WATERSHED

| HYDROLOGIC SOIL GROUP (HSG) | HYDROLOGIC SOIL GROUPS BY SUB-BASINS (acres) | | | | | | | GRAND TOTAL (acres) | PERCENT OF TOTAL (%) |
|-----------------------------|--|---------------|---------------|---------------|---------------|---------------|---------------|---------------------|----------------------|
| | 1 | 2 | 3 | 4 | 5 | 6 | 7 | | |
| A | 1,318.49 | 306.51 | 893.60 | 946.88 | 814.38 | 352.76 | 136.36 | 4,768.98 | 88.9 |
| A / D | 53.48 | -- | 2.37 | 5.55 | 0.78 | 63.41 | 29.94 | 155.53 | 2.9 |
| D | 103.17 | -- | 1.13 | -- | -- | 22.20 | 169.06 | 295.54 | 5.5 |
| W | 11.92 | -- | 38.36 | 2.67 | 19.50 | 59.45 | 14.73 | 146.63 | 2.7 |
| TOTAL: | 1,487.05 | 306.51 | 935.46 | 955.10 | 834.66 | 497.82 | 350.08 | 5,366.68 | 100.0 |

3.5 Stormsewer System

Marco Island has constructed an extensive stormsewer system to discharge runoff generated during rain events. An overview of the current stormsewer system is given on Figure 3-5. Most stormsewer systems are relatively short in length and discharge surface runoff into the nearest canal system or open water. Overall, the Marco Island stormsewer system has 1,864 stormsewer inlets with 1,324 of the current inlets (71%) retrofitted with inlet filters manufactured by Suntree which are designed to remove leaves, litter, and solid debris. The inlets are periodically cleaned and serviced by City personnel.

Currently, Marco Island has 393 stormsewer outfalls, with the vast majority discharging to the canal system. Only one of the outfalls discharges directly to the Gulf of Mexico, with 7 outfalls discharging to Barfield Bay, 10 outfalls discharging to Roberts Bay, 2 outfalls discharging to Caxambas Bay, and 5 outfalls discharging to Collier Bay.

3.6 Topography

Topographic information for the Marco Island drainage basin was obtained using the 2018 1-ft LIDAR elevation contour maps developed by USGS. The delineated drainage basin boundary was superimposed over the aerial contour maps to develop the drainage basin topographic map. A topographic map for the Marco Island drainage basin is given on Figure 3-6, with an elevation range of -4 ft to 50 ft. Elevation contours for the Marco Island drainage basin range from near 0 ft (NAVD88) adjacent to open water to approximately 45-50 ft (NAVD88) in the relic dune area located along the southeast perimeter of the island.

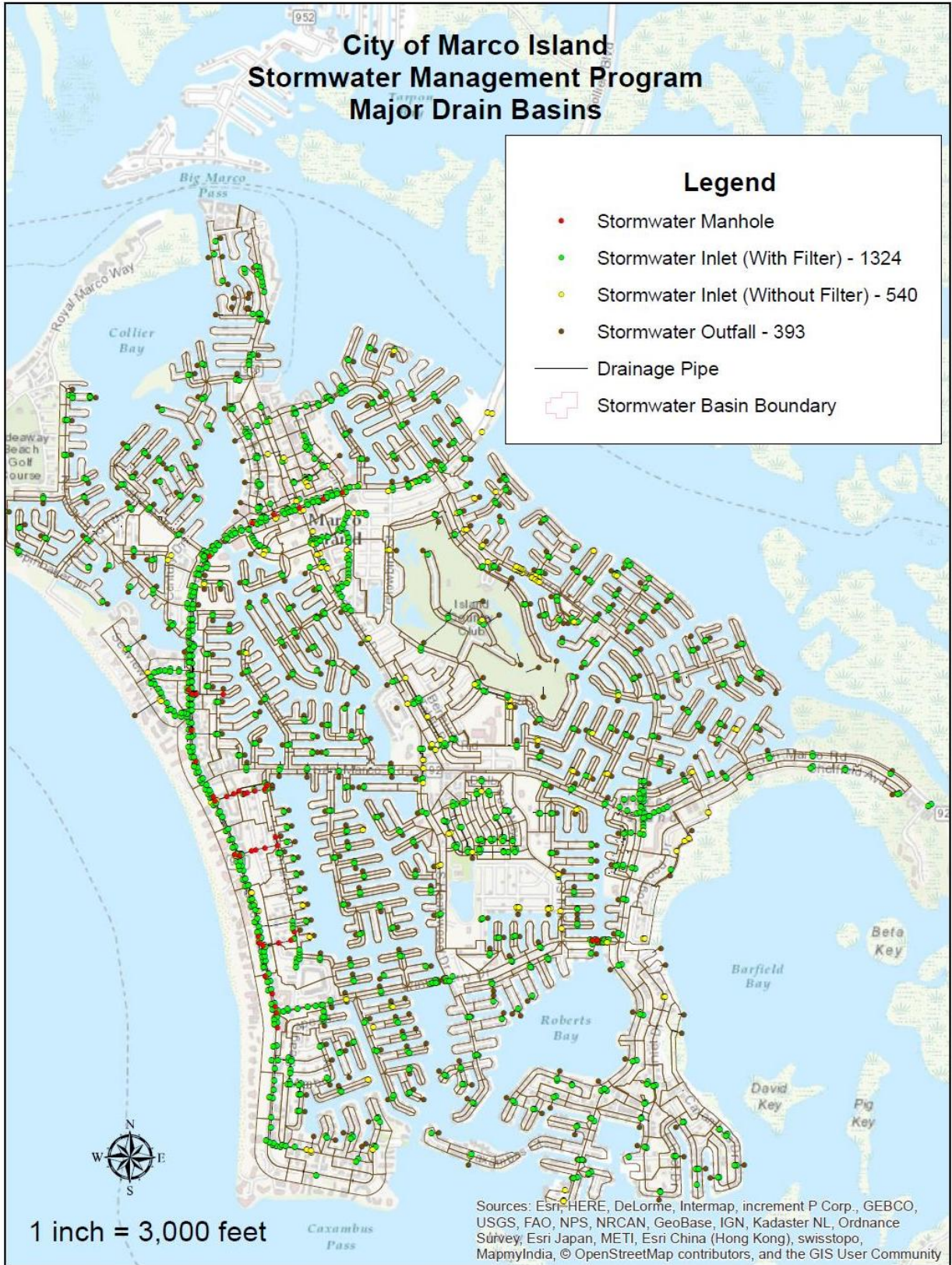

Figure 3-5. City of Marco Island Stormsewer System.
(Source: City of Marco Island Public Works Department)

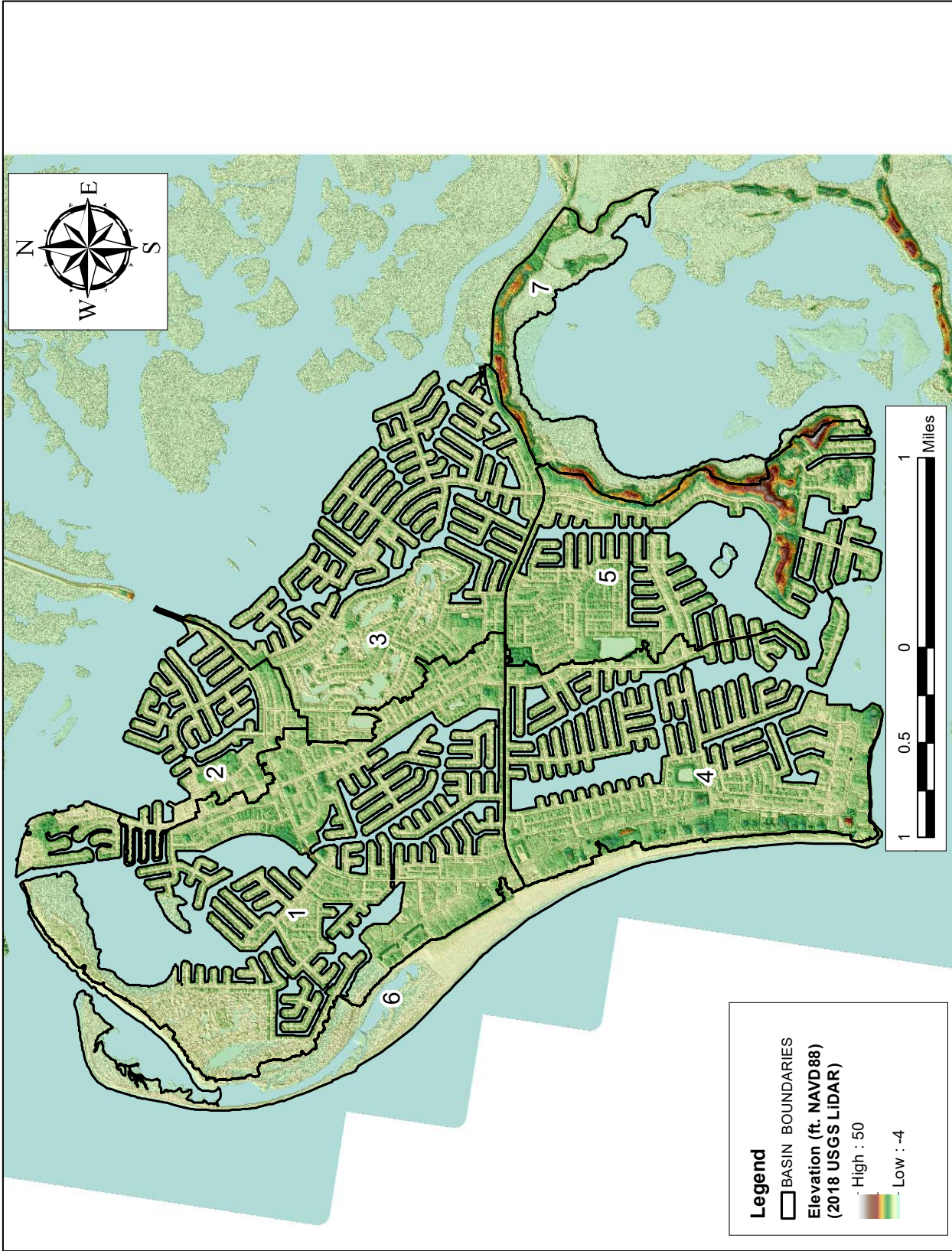

Figure 3-6. Topographic Map of the Marco Island Drainage Basin. (Source: USGS, 2018)

Although a small portion of the City has elevations as high as 45-50 ft, the vast majority of Marco Island has land elevations less than 10 ft. A topographic map with a range of 0-10 ft is given on Figure 3-7. Central portions of the island are relatively flat with elevations ranging from 4-10 ft (NAVD88).

3.7 Sewage Disposal

Currently, disposal of sanitary sewage on Marco Island occurs almost exclusively using a central sewer collection system. According to the Water and Sewer Department (W&SD), only approximately 20-21 on-site treatment systems remain on the Island, and the remaining systems will be phased out by 2024.

Collected raw sewage is transported through an extensive network of underground sewer mains to a sewage treatment facility located south of Factory Bay near the intersection of E. Elkcam and Windward Drive, referred to as the Marco Island Reclaimed Water Production Facility (RWPF). The sewage facility provides treatment for wastewater generated on Marco Island along with the Isles of Capri and Goodland. A photograph of the Marco Island Wastewater Treatment Facility is given on Figure 3-8.

Raw wastewater is sent to the RWPF where a Modified Ludzack-Ettinger (MLE) process is used to reduce nitrogen concentrations through denitrification using a series of anoxic and aerobic stages. Following this process, the water is screened using 3 parallel rotary drum screens to remove solids. The raw screened sewage is sent to 2 biological treatment tanks which consist primarily of aeration tanks designed for removal of organic matter through microbial digestion. Following biological treatment, the water is sent to 5 Zenon membrane filtration units and then to 2 chlorine contact chambers. Treated wastewater which does not meet specifications for reuse is sent to 2 deep injection wells. Reuse water is stored in 2 on-site 500,000-gallon tanks used to feed the reuse distribution system. The sludge from wastewater treatment is thickened and sent to an off-site biosolids compost processing facility.

A schematic of the RWPF wastewater treatment process is given on Figure 3-9. The plant has a permitted treatment capacity of 4.92 million gallons per day (MGD), but the average flow from 2011-2020 has been less than half of this value. The Marco Island wastewater facility is operated by the Marco Island Water and Sewer Department. A division referred to as the Collection and Distribution (C&D) team is responsible for all buried water and wastewater assets including potable water mains, raw water mains, sewer mains, and reuse water mains. The existing sewer system contains 287 miles of mains and 2,127 manholes.

In addition to the primary wastewater facility, the City previously operated a small plant, referred to as the Marco Shores Wastewater Treatment Plant (WWTP), which served the Old Marco district. However, this plant was decommissioned and demolished in February 2020. The permitted capacity of this facility was 0.30 MGD, with the treated wastewater disposed of in 21 acres of rapid infiltration basins (RIBs) where the effluent discharged into shallow groundwater.

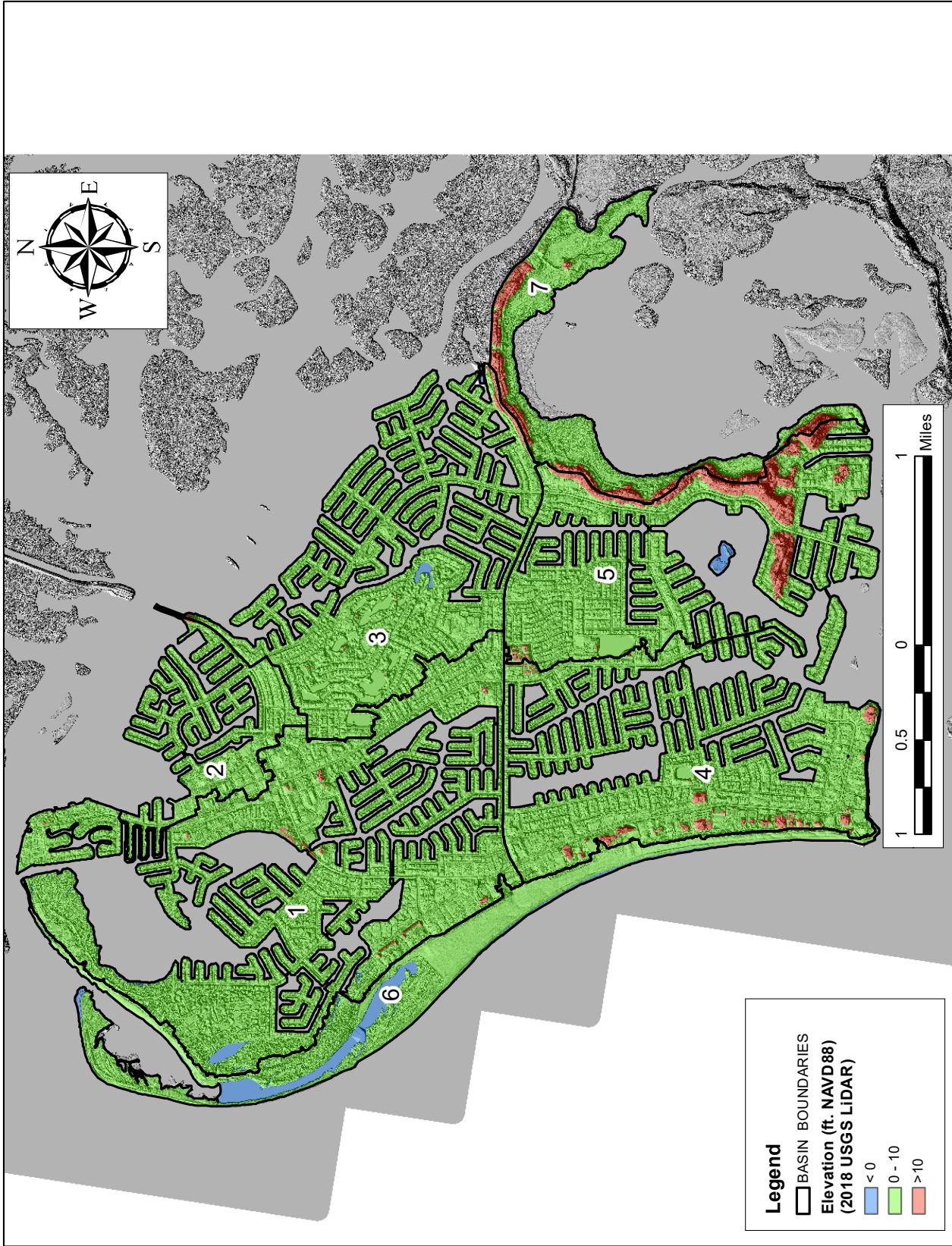

Figure 3-7. Limited Range Topographic Map for Marco Island. (Source: USGS)



Figure 3-8. Photo of the City of Marco Island Wastewater Treatment Facility.
(Source: City of Marco Island)

A summary of average daily inflow rates for the Marco Island and Marco Shores wastewater treatment plants is given in Table 3-6, based on annual reporting forms submitted to FDEP by the City covering the period from 2011-2020. Monitored inflow rates to the RWPF have ranged from 1.90-2.45 MGD, with increases in inflow observed during each annual period except 2016-2017. In contrast, inflows to the Marco Shores WWTP have remained relatively consistent over time. Each of the two plants is currently operating at less than 50% of the permitted capacities. The values provided in Table 3-6 reflect annual average inflow rates, but a large seasonal variability occurs with greater flows during milder portions of the year and minimum inflow during summer.

TABLE 3-6

**SUMMARY OF AVERAGE DAILY INFLOW RATES FOR THE
MARCO ISLAND AND MARCO SHORES WWTPs FROM 2011-2020**

| FACILITY | PERMITTED CAPACITY (MGD) | AVERAGE INFLOW (MGD) | | | | | | | | | AVERAGE (MGD) |
|-------------------|--------------------------|----------------------|-------------|-------------|-------------|-------------|-------------|-------------|-------------|-------------|---------------|
| | | 2011-2012 | 2012-2013 | 2013-2014 | 2014-2015 | 2015-2016 | 2016-2017 | 2017-2018 | 2018-2019 | 2019-2020 | |
| Marco Island WWTP | 4.92 | 1.90 | 2.00 | 2.01 | 2.04 | 2.09 | 2.05 | 2.17 | 2.27 | 2.45 | 2.11 |
| Marco Shores WWTP | 0.300 | 0.085 | 0.089 | 0.089 | 0.103 | 0.097 | 0.093 | 0.091 | 0.087 | 0.086 | 0.091 |
| TOTAL: | | 1.98 | 2.09 | 2.10 | 2.14 | 2.19 | 2.14 | 2.26 | 2.36 | 2.54 | 2.20 |

RECLAIMED WATER PRODUCTION FACILITY

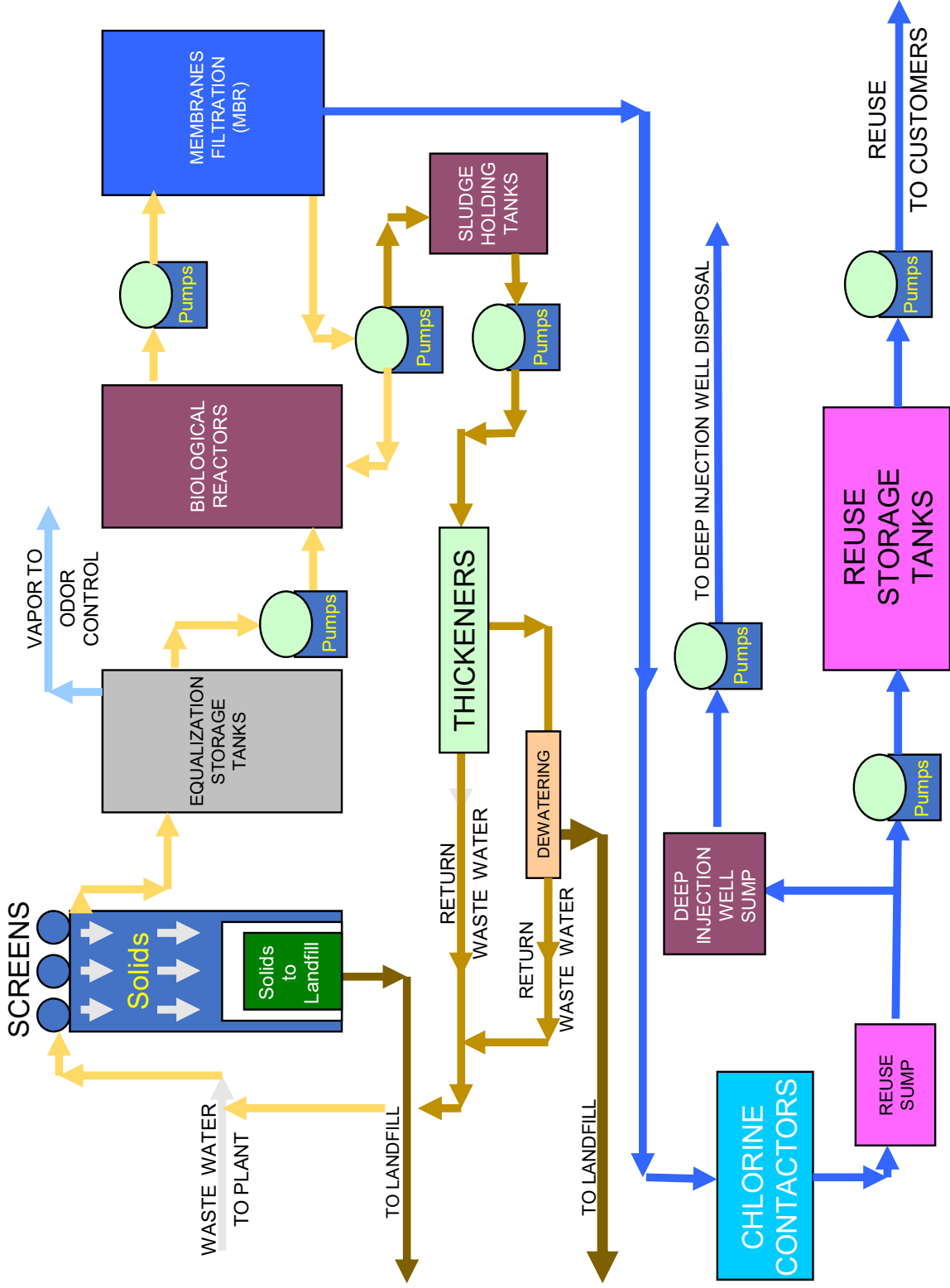

Figure 3-9. Schematic of the City of Marco Island Wastewater Treatment Process.

3.8 Reuse Irrigation

Virtually all sewage treated at the Marco Island wastewater treatment plant becomes reuse irrigation and, according to the W&SD, the demand often exceeds the availability. During these conditions, raw water from the City's primary drinking water source is used to augment the reuse system either directly or indirectly. Typically, this water is sent directly to either the Marco Island or Marco Shores golf course through dedicated pipelines. Raw drinking water can also be used to augment the reuse system as a whole. To augment the reuse system, raw water enters the head of the chlorine contact chamber at the treatment plant, is disinfected, and sent out through the pressurized distribution system to points of application. All 3 golf courses store the reclaimed water in their storage area (lake or tank) prior to distributing.

A map of current and potential reuse irrigation customers is given on Figure 3-10. Under current conditions, reuse is applied exclusively to commercial and multi-family properties, including 3 City parks, 2 schools, and 3 separate golf courses. The largest golf course customer is the Marco Island Golf Course, an 18-hole course which stores the reuse water in a series of unlined lakes prior to application. Reuse water is also sent to the Marco Shores Golf Course, an off-island 18-hole course where the reuse water is stored in a HDPE-lined lake, and the Hideaway Beach Golf Course, a 9-hole course where reuse water is stored in an uncovered tank. The current reuse application area is approximately 864 acres, with another 100 acres listed as potential customers. The reuse system contains more than 42 miles of distribution mains.

A summary of reuse water consumption from 2011-2020 is given in Table 3-7 based on the Annual Reuse Reports submitted by the City to FDEP from 2011-2020. The treated wastewater flows in Table 3-7 are based on the information from the Marco Island WWTP provided in Table 3-6. The City supplements the treated wastewater with an additional limited flow from the raw drinking water source. The average daily flow available for reuse irrigation from October 1, 2019-September 30, 2020 is 2.47 MGD.

TABLE 3-7

SUMMARY OF RECLAIMED WATER AND SUPPLEMENTAL WATER CONSUMPTION BY REUSE CUSTOMERS

| PARAMETER | AVERAGE FLOW (MGD) | | | | | | | | | AVERAGE (MGD) |
|--------------------------------------|--------------------|-------------|-------------|-------------|-------------|-------------|-------------|-------------|-------------|---------------|
| | 2011-2012 | 2012-2013 | 2013-2014 | 2014-2015 | 2015-2016 | 2016-2017 | 2017-2018 | 2018-2019 | 2019-2020 | |
| Treated Water from Marco Island WWTP | 1.90 | 2.00 | 2.01 | 2.04 | 2.09 | 2.05 | 2.17 | 2.27 | 2.45 | 2.11 |
| Raw Water Source | 0.17 | 0.11 | 0.11 | 0.07 | 0.01 | 0.10 | 0.13 | 0.05 | 0.02 | 0.09 |
| TOTAL: | 2.07 | 2.11 | 2.12 | 2.11 | 2.10 | 2.15 | 2.30 | 2.32 | 2.47 | 2.20 |

SOURCE: Annual Reuse Reports submitted by the City to FDEP - Form 62-610.300(4)(a)2

A summary of reuse application and disposal from 2011-2020 is given in Table 3-8. Of the total available reuse water, approximately 80-90% is used for surface irrigation, with the remaining 10-20% discharged to a deep groundwater injection well, typically during wet weather conditions when sufficient surface storage is not available. Water which does not meet reuse criteria can be diverted to the “substandard” pond where it is stored prior to re-treatment. The total annual reuse water application and disposal volumes in Table 3-8 are identical to the generated reuse volumes summarized on the bottom of Table 3-7.

TABLE 3-8

SUMMARY OF REUSE WATER APPLICATION AND DISPOSAL FOR THE MARCO ISLAND WWTP FROM 2011-2020

| PARAMETER | AVERAGE FLOW (MGD) | | | | | | | | |
|--------------------|--------------------|-------------|-------------|-------------|-------------|-------------|-------------|-------------|-------------|
| | 2011-2012 | 2012-2013 | 2013-2014 | 2014-2015 | 2015-2016 | 2016-2017 | 2017-2018 | 2018-2019 | 2019-2020 |
| Reuse Applied | 1.83 | 1.64 | 1.77 | 1.89 | 1.56 | 1.77 | 2.08 | 1.89 | 1.97 |
| Deep Well Disposal | 0.24 | 0.47 | 0.35 | 0.22 | 0.54 | 0.38 | 0.22 | 0.43 | 0.50 |
| TOTAL: | 2.07 | 2.11 | 2.12 | 2.11 | 2.10 | 2.15 | 2.30 | 2.32 | 2.47 |

SOURCE: Annual Reuse Reports submitted by the City to FDEP - Form 62-610.300(4)(a)2

Once the reuse has been generated, the City uses multiple ponds and tanks to store the water between irrigation events. Each of these facilities is connected to the reuse system through buried pipelines. A listing of reuse water storage facilities used by the City is given in Table 3-9. Reuse is stored in both lined and unlined ponds as well as covered and uncovered tanks. Water is withdrawn from these facilities during irrigation events.

A summary of major reuse water users, defined as average consumption >0.1 MGD, is given in Table 3-10. The permitted disposal capacity is provided along with the acreage for each user. The irrigation areas are based on information provided by the City to FDEP for the required annual reporting of reuse activities summarized on FDEP Form 62-610.300(4)(a)2. The largest permitted annual user of reuse is landscaping along Collier Blvd., followed by the miscellaneous users and the golf course areas. The Hammock Bay Golf Course is located off-island, so the total area irrigated with reuse water on Marco Island is about 734 acres based on the information provided in Table 3-10. However, the areas listed in Table 3-10 appear to reflect parcel areas which include both pervious and impervious areas rather than grassed or landscaped areas only, so the actual area irrigated is less than the areas indicated on Table 3-10.

TABLE 3-9**MARCO ISLAND RECLAIMED WATER STORAGE FACILITY INVENTORY**

| FACILITY NAME | LOCATION | FUNCTION | FACILITY TYPE |
|-----------------------------|------------------------|-----------------|--|
| Marco Island Golf Course | Central Marco Island | System storage | Unlined pond |
| Marco Shore GC Storage Pond | Mainsail Drive, Naples | System storage | Lined pond |
| Hideaway Beach Golf Course | North Marco Island | System storage | Uncovered tank |
| Reject Storage | 807 Elkcaml Circle, E | Reject storage | Lined pond |
| Public Access Storage Tank | 807 Elkcaml Circle, E | System storage | Covered tanks (2-0.5 MG) |
| Utility Storage Tank | Mainsail Drive, Naples | System storage | Covered tank (1-0.5 MG) (demolished 2019) |

SOURCE: Annual Reuse Reports submitted by the City to FDEP - Form 62-610.300(4)(a)2

TABLE 3-10

**SUMMARY OF MAJOR REUSE WATER USERS FOR THE
MARCO ISLAND AND MARCO SHORES WWTPs FROM 2011-2020
(> 0.1 MGD)**

| USER NAME | USER TYPE | CAPACITY (MGD) | ACREAGE (acres) |
|---|----------------------------|---------------------------|----------------------------|
| Marco Island Golf Course | Golf course | 0.450 | 154 |
| Hammock Bay (Marco Shores) | Golf course | 0.342 | 130 |
| Hideaway Beach Golf Course and Country Club | Golf course | 0.181 | 30 |
| Collier Blvd. Users (condos, medians) | Residential developments | 0.965 | 250 |
| Miscellaneous Users (side streets of Collier Blvd., condos along Elkcaml Circle, schools and parks, off-island areas) | Other landscape irrigation | 0.496 | 300 |
| | TOTAL: | 2.434 | 864 |

SOURCE: Annual Reuse Reports submitted by the City to FDEP - Form 62-610.300(4)(a)2

A summary of reuse irrigation application areas and volumes from 2011-2020 is given in Table 3-11 based on Annual Reuse Reports provided by the City to DEP. Separate data are provided for the 314-acre golf course application area and the 550-acres of other public access areas. Average application rates for reuse irrigation on the golf course and public areas from 2011-2020 have ranged from 1.64-2.08 MGD. Currently, application of reuse water is not regulated by the City, and there are no restrictions on irrigation volume, frequency, or application rates. The City charges a fee for reuse water which varies by end user.

TABLE 3-11

**SUMMARY OF REPORTED REUSE IRRIGATION AREAS AND VOLUMES
FOR THE MARCO ISLAND AND MARCO SHORES WWTPs FROM 2011-2020**

| REUSE AREA | IRRIGATED AREA (acres) | CAPACITY (MGD) | AVERAGE FLOW (MGD) | | | | | | | | |
|---------------------|------------------------|----------------|--------------------|-------------|-------------|-------------|-------------|-------------|-------------|-------------|-------------|
| | | | 2011-2012 | 2012-2013 | 2013-2014 | 2014-2015 | 2015-2016 | 2016-2017 | 2017-2018 | 2018-2019 | 2019-2020 |
| Golf Course | 314 | 0.973 | 0.67 | 0.50 | 0.50 | 0.45 | 0.34 | 0.42 | 0.65 | 0.55 | 0.52 |
| Other Public Access | 550 | 1.461 | 1.16 | 1.14 | 1.27 | 1.44 | 1.22 | 1.35 | 1.43 | 1.34 | 1.45 |
| TOTAL: | 864 | 2.434 | 1.83 | 1.64 | 1.77 | 1.89 | 1.56 | 1.77 | 2.08 | 1.89 | 1.97 |

SOURCE: Annual Reuse Reports submitted by the City to FDEP - Form 62-610.300(4)(a)2

A summary of reuse application rates for golf course and public access areas on Marco Island from 2015-2020 is given on Table 3-12. The average daily reuse application rate to the golf courses over this period is 0.496 MGD, with an average of 1.36 MGD applied to the public access areas. Based on the report forms provided to FDEP by the City, golf course areas irrigated with reuse water, including the Marco Island and Marco Shore golf courses, cover approximately 284 acres. However, an independent analysis of the golf course areas by ERD indicated an area of 263.8 acres total with 229.99 acres of pervious surfaces which could be irrigated. Using the average application rate of 0.496 MGD to golf course areas, and including only pervious areas, the average application rate is 0.56 inches/week.

The surface area of public access areas receiving reuse irrigation is stated to be 550 acres by the City. An independent analysis of these areas by ERD, based on the active reuse parcel map shown on Figure 3-10 and discussions with City personnel, indicated an area of 638.5 acres, with 332.8 acres of pervious surfaces suitable for irrigation. Using the average daily application rate of 1.36 MGD to pervious areas, the average reuse application rate to common areas is 0.88 inches/week. An additional discussion of areas with reuse irrigation is given in Section 4.1.3.

TABLE 3-12

**REUSE APPLICATION RATES FOR GOLF COURSE
AND PUBLIC ACCESS AREAS FROM 2015-2020**

| REUSE AREA | IRRIGATED AREAS (acres) | AVERAGE APPLICATION RATES | |
|---------------------|-------------------------|---------------------------|-----------|
| | | MGD | inch/week |
| Golf Courses | 229.99 | 0.496 | 0.56 |
| Other Public Access | 398.96 | 1.36 | 0.88 |
| TOTAL: | 628.95 | | |

The City conducts routine monitoring of the water quality characteristics of reuse irrigation on a weekly basis, with laboratory analyses conducted for orthophosphorus (PO₄), nitrate (NO₃), total Kjeldahl nitrogen (TKN), total nitrogen, and TSS. A compilation of weekly analyses conducted on reuse irrigation was provided to ERD by the City over the 10-year period from 2012-2021. A complete listing of the results of these analyses is given in Appendix A-6.

A graphical summary of temporal variability in Marco Island reuse water characteristics from 2012-2021 is given on Figure 3-11. Individual measurements are illustrated for each weekly monitoring event, with annual geometric mean values for each parameter indicated as **black dots** to provide a less cluttered view of potential long-term trends.

Generated flow rates for reuse irrigation have been highly variable over the period of record, with measured values ranging from approximately 0.5-3.0 MGD. A definite seasonal pattern is present in the flow data, with higher flow rates during winter conditions and lower flow rates during summer, although the seasonal variability is less pronounced in recent years. A trend analysis of flow rates was conducted using the linear regression technique discussed previously in Section 2.2.1.9, and the analysis of reuse flow rates indicates a highly significant (>99% confidence level) of increasing flow rate over time, with an annual increase of 0.08 MGD per year.

Measured concentrations of orthophosphorus have also been highly variable in reuse water, ranging from <0.1 mg/l to approximately 12 mg/l. A cyclic pattern is also apparent for measured orthophosphorus concentrations, with the highest values observed during winter conditions and the lowest values observed during summer, although the variability appears to be less pronounced in recent years. The trend analysis conducted for changes in orthophosphorus concentrations indicates that there is no significant trend of increasing or decreasing values over time.

Measured concentrations of nitrate in reuse water have also been highly variable, ranging from near zero to more than 30 mg/l. Peak values for nitrate appear to have occurred during 2017 and 2018, although the cause for these elevated values is not known. A seasonal pattern is also apparent in measured nitrate concentrations, although not to the extent observed for discharge and orthophosphorus. The regression analysis indicates no significant trend of either increasing or decreasing nitrate concentrations.

Measured concentrations of TKN in reuse water have exhibited a higher level of consistency in values compared with the previous parameters, with the vast majority of measured TKN values ranging from 1-2 mg/l, although concentrations exceeding 7 mg/l have been observed. The trend analysis indicates a statistically significant trend (99% confidence level) of decreasing concentrations of TKN in reuse water over time.

Measured concentrations of total nitrogen in reuse water have been highly variable, ranging from near zero to more than 30 mg/l. A seasonal pattern is also apparent in the total nitrogen data, although not as definitive as those observed for discharge, orthophosphorus, or nitrate. Measured concentrations of total nitrogen frequently exceed the maximum groundwater limit for total nitrogen of 10 mg/l established by US EPA, and groundwater disposal of the reuse water could result in an exceedance of this value rendering the aquifer unsuitable for potable use. The trend analysis indicates no significant trend of either decreasing or increasing concentrations of total nitrogen in reuse water over time.

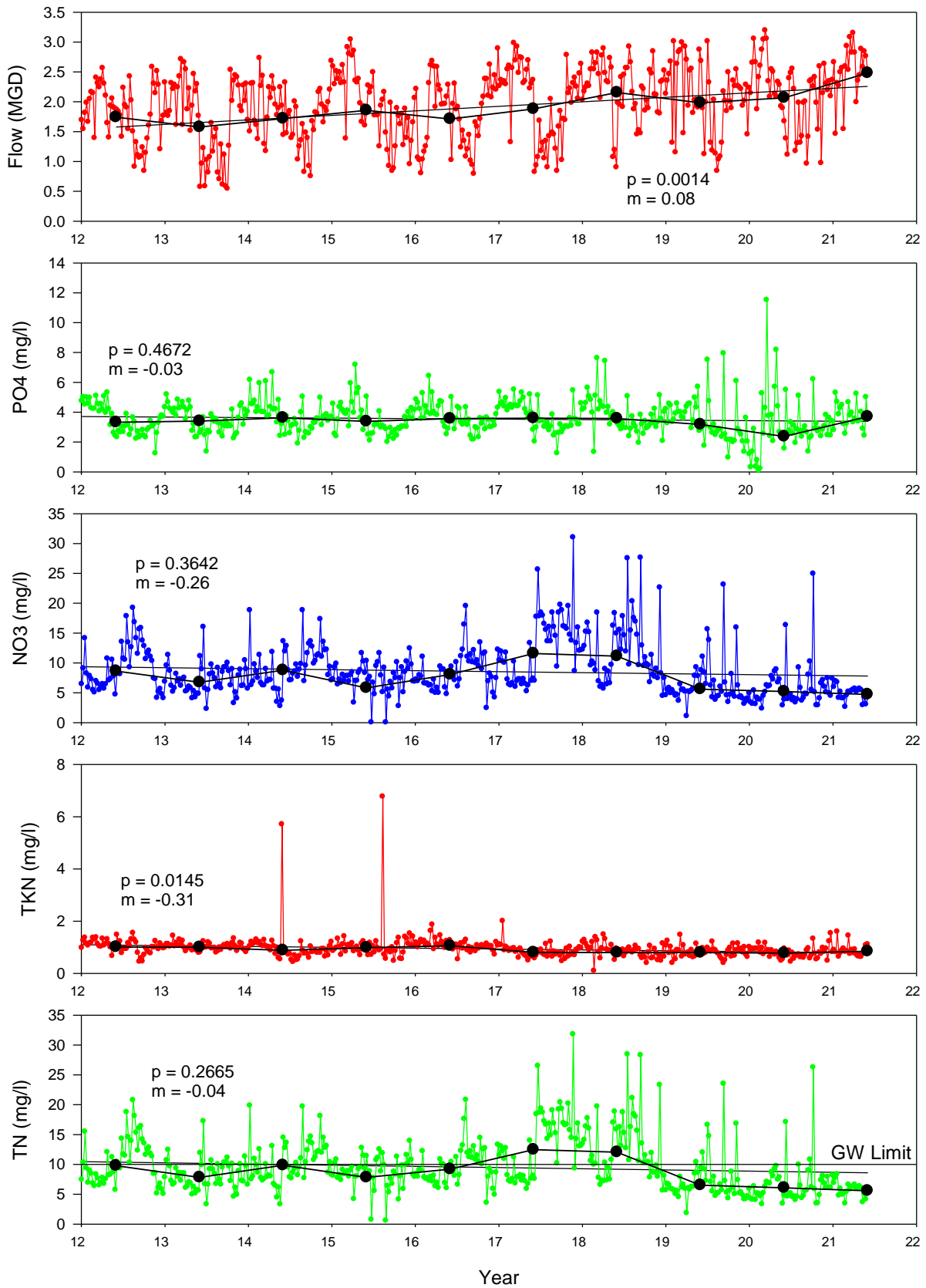

Figure 3-11. Temporal Variability in Marco Island Reuse Water Characteristics from 2012-2021.

Summary statistics for Marco Island reuse irrigation water from 2012-2021 are given in Table 3-13. Available data for 2021 include information collected through June 2, 2021. Information is provided in Table 3-13 for overall minimum values, maximum value, and geometric mean for all measurements conducted from 2012-2021. Differences between minimum and maximum values for all laboratory-measured parameters cover a range of at least 1-2 orders of magnitude. The geometric mean value for orthophosphorus is 3.33 mg/l, with an annual geometric mean value of 8.63 mg/l for total nitrogen and approximately 87% comprised of nitrate.

TABLE 3-13

**SUMMARY STATISTICS FOR MARCO
ISLAND REUSE IRRIGATION FROM 2012-2021**

| PARAMETER | REUSE | | | | | |
|-----------------|---------------|---------------------------|---------------------------|---------------|-------------------|---------------|
| | Flow (MGD) | PO ₄ (mg/l) | NO ₃ (mg/l) | TKN (mg/l) | Total N (mg/l) | TSS (mg/l) |
| Minimum Value | 0.54 | 0.08 | 0.01 | 0.09 | 0.56 | 0.30 |
| Maximum Value | 3.19 | 11.50 | 31.00 | 6.76 | 31.77 | 3.70 |
| GEOMEAN: | 1.87 | 3.33 | 7.49 | 0.89 | 8.63 | 0.47 |

Annual geometric mean values for Marco Island reuse irrigation from 2012-2021 are given on Table 3-14. Peak concentrations for both nitrate and total nitrogen occurred from the period from 2017-2018, with some of the lowest measured annual values for TKN. Overall, the reuse irrigation water contains extremely elevated levels of inorganic forms of both nitrogen and phosphorus in a form immediately available for uptake by either terrestrial or aquatic vegetation and organisms.

TABLE 3-14

**ANNUAL GEOMETRIC MEAN VALUES FOR MARCO
ISLAND REUSE IRRIGATION FROM 2012-2021**

| PARAMETER | REUSE | | | | | |
|--------------------|---------------|---------------------------|---------------------------|---------------|-------------------|---------------|
| | Flow (MGD) | PO ₄ (mg/l) | NO ₃ (mg/l) | TKN (mg/l) | Total N (mg/l) | TSS (mg/l) |
| 2012 | 1.74 | 3.33 | 8.64 | 1.01 | 9.78 | 0.62 |
| 2013 | 1.58 | 3.40 | 6.76 | 1.00 | 7.82 | 0.60 |
| 2014 | 1.72 | 3.62 | 8.77 | 0.88 | 9.85 | 0.60 |
| 2015 | 1.86 | 3.38 | 5.82 | 0.98 | 7.82 | 0.61 |
| 2016 | 1.71 | 3.57 | 8.05 | 1.06 | 9.20 | 0.60 |
| 2017 | 1.88 | 3.60 | 11.58 | 0.80 | 12.47 | 0.46 |
| 2018 | 2.16 | 3.58 | 11.13 | 0.80 | 12.06 | 0.30 |
| 2019 | 1.98 | 3.17 | 5.62 | 0.80 | 6.52 | 0.35 |
| 2020 | 2.07 | 2.38 | 5.22 | 0.78 | 6.07 | 0.30 |
| 2021 | 2.48 | 3.70 | 4.72 | 0.84 | 5.60 | 0.33 |
| MEAN VALUE: | 1.92 | 3.37 | 7.63 | 0.89 | 8.72 | 0.48 |

3.9 Stormwater Treatment

Watershed areas which currently receive stormwater treatment within the Marco Island drainage basin were identified by ERD using a combination of aerial photography, field reconnaissance, and a review of historical permitting records in possession of SFWMD. A summary of the results of this evaluation is given on Figure 3-12 which illustrates parcels with permitted and non-permitted stormwater management systems within the Marco Island drainage basin during June 2020. Permitted stormwater management systems within the basin area consist primarily of dry retention ponds (which rely upon infiltration of runoff into the soil) and wet detention ponds (which provide stormwater treatment by a combination of physical settling of particles and biological uptake of nutrients).

Areas using roadside swales for runoff conveyance, whether part of a permitted stormwater system or not, are also indicated on Figure 3-12 since swale systems, even those designed primarily for conveyance purposes, can provide both a reduction in runoff volume and a decrease in nutrient concentrations. Since this analysis is used to estimate runoff loadings to adjacent receiving waters, it includes all areas where reductions in runoff volume and/or mass loading can be achieved regardless of whether or not the mechanism is a permitted stormwater management facility.

As indicated on Figure 3-12, virtually all of the currently developed parcels within the Marco Island drainage basin west have existing stormwater treatment facilities and mechanisms, consisting primarily of dry retention ponds and roadside swales. Dry retention is used primarily in commercial areas north of N. Collier Blvd. and along the hotel and high-rise corridor area on the west and southwest sides of the island. Virtually all residential areas have swale treatment systems, with golf course areas treated by internal ponds which are also used for storage of reuse water.

3.10 Hydrologic Characteristics

Hydrologic characteristics were evaluated for each of the identified sub-basin areas discharging to Marco Island under existing conditions (June 2020) for use in hydrologic modeling to calculate annual runoff inputs to the waterways. The hydrologic modeling, discussed in Section 4, is based upon the methodology developed by Harper and Baker (2007) which uses a modified SCS curve number methodology to calculate runoff volumes based upon the hydrologic characteristics of the drainage basin, including impervious area, directly connected impervious area (DCIA), and soil curve number values (CN values) to estimate runoff volumes for modeled storm events. This is the standard methodology used by Water Management Districts and FDEP for calculating loadings for TMDL studies and pre- vs. post-loading analyses. Hydrologic characteristics of the sub-basin areas were determined for each of the identified land use types in each sub-basin area in Marco Island drainage basin.

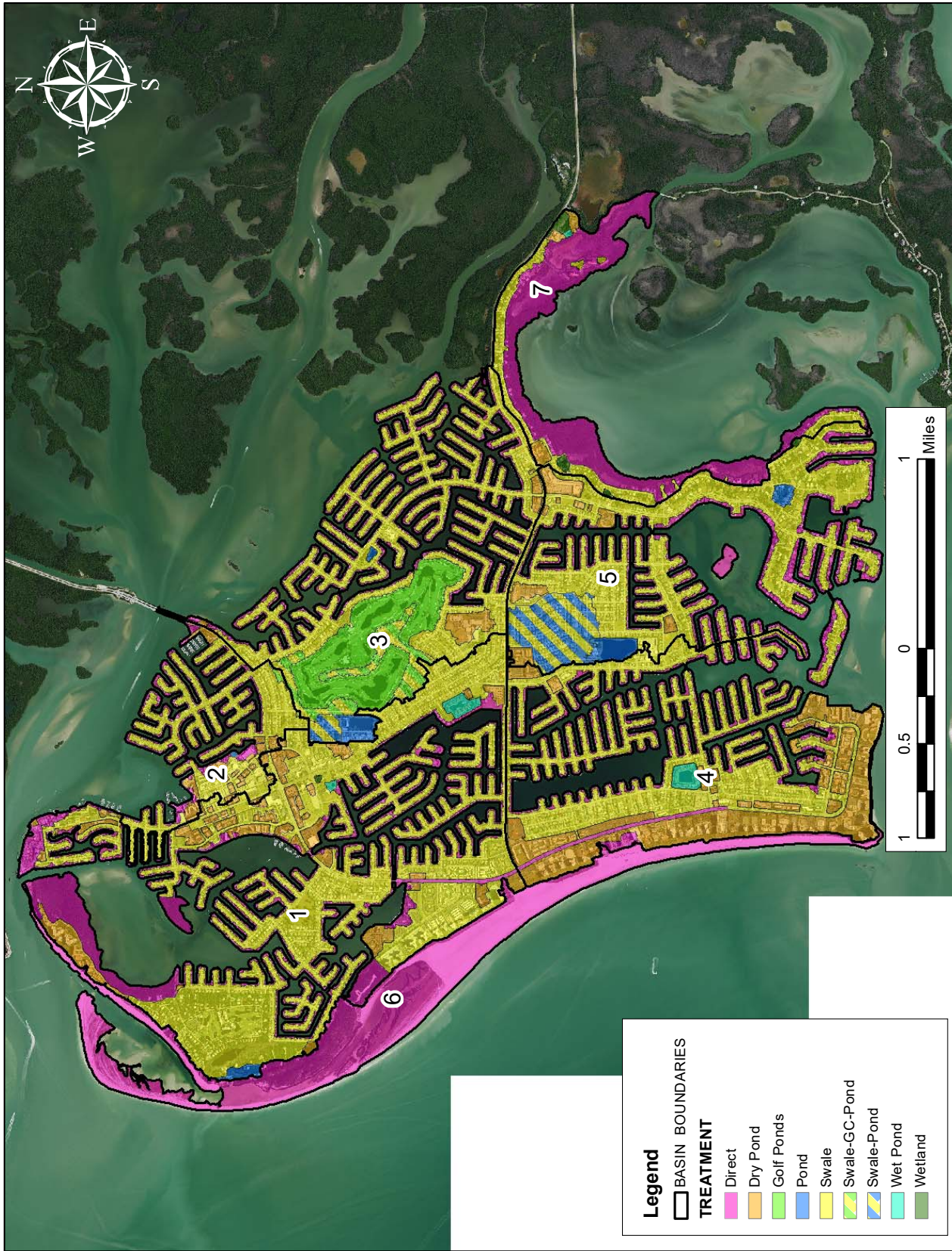

Figure 3-12. Stormwater Treatment Areas in the Marco Island Drainage Basin.

3.10.1 Impervious Areas

Impervious areas in the Marco Island watershed were delineated by ERD using aerial photography to calculate the impervious area within each sub-basin area and developed land use type. Impervious areas include all areas which prevent infiltration of runoff into the ground, such as homes, driveways, roadways, sidewalks, patios, pools, buildings, etc. The impervious area was then expressed as a percentage of the total area for each identified land use type and sub-basin.

All impervious areas in the Marco Island drainage basin were digitized by ERD to separate pervious and impervious areas in each sub-basin. Examples of digitized impervious areas for medium-density residential parcels are given in Figure 3-13. Impervious percentages for residential areas ranged from 45.6-58.0%, with an average of 50.7%.

3.10.2 Directly Connected Impervious Percentages

One of the parameters used in the modified SCS curve number methodology developed by Harper and Baker for estimating runoff volumes is the directly connected impervious areas (DCIA). DCIA reflects impervious surfaces which are hydraulically connected to the stormsewer or drainage system such that runoff generated on these impervious surfaces flows directly into the drainage system without first flowing over pervious surfaces. Runoff generated in these areas is assumed to discharge directly into the drainage system with losses occurring only as a result of initial abstraction on impervious surfaces which evaporates following the rain event.

Residential areas on Marco Island have no DCIA since the drainage system consists of vegetated roadside swales. The most significant DCIA percentages are located in commercial areas, highways, and a few of the multi-family condos and apartments with large parking areas.

3.10.3 Curve Numbers

One of the most important parameters used by the SCS curve number methodology is the curve number (CN) value which is a variable parameter used to estimate runoff depths for modeled rain events based upon soil characteristics and land cover. A discussion of soil characteristics within the Marco Island drainage basins was provided in Section 3.4. The SCS curve number methodology assigns curve number values to each of the hydrologic soil groups discussed in Section 3.4 as a function of land cover for each soil type. Curve number values range from approximately 30-98 and reflect the runoff generating potential for a particular combination of soil type and land cover.

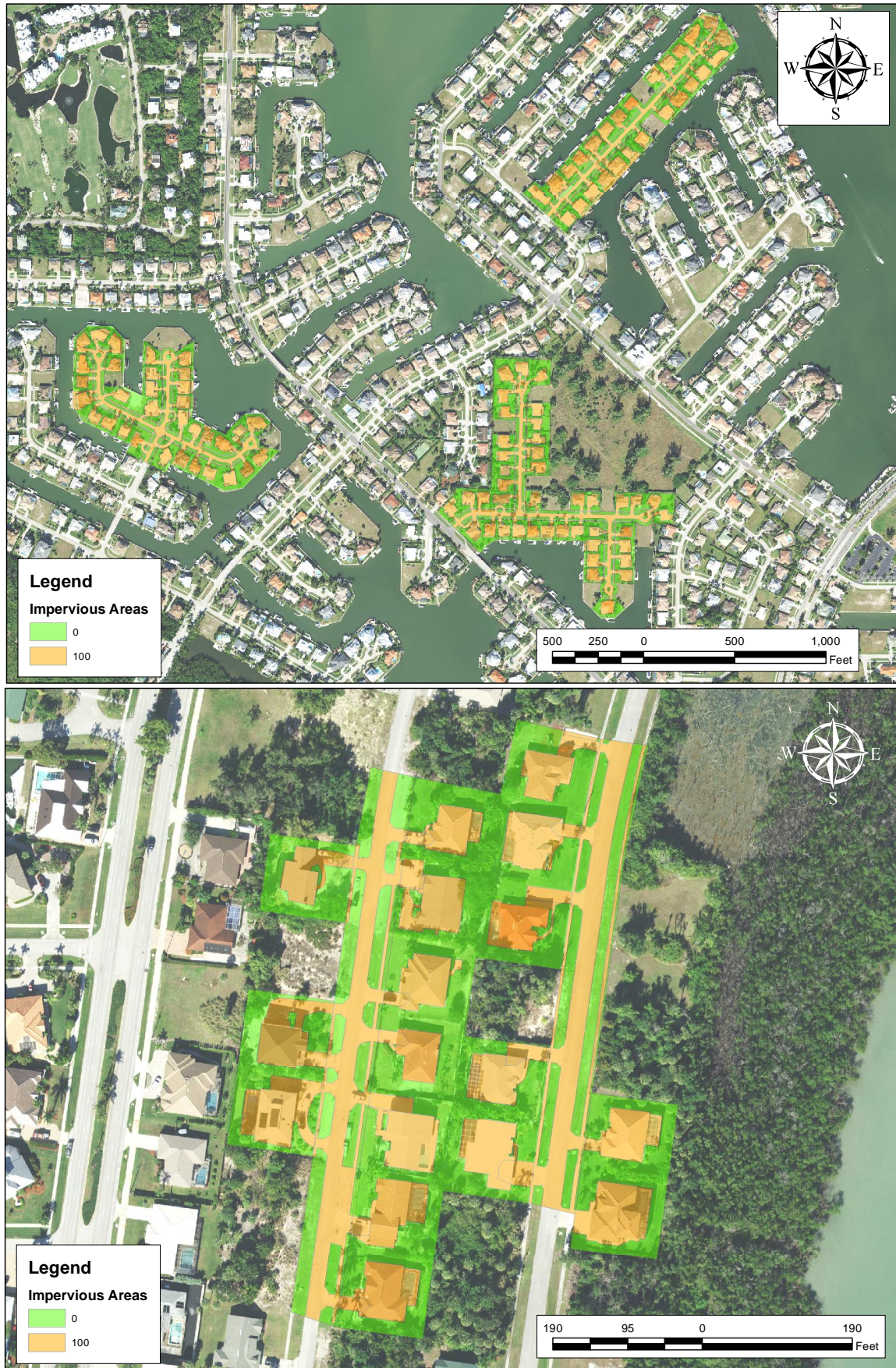

Figure 3-13. Examples of Delineated Impervious Areas for Residential Parcels.

The hydrologic model used in this report to estimate generated runoff volumes conducts separate modeling for DCIA and non-DCIA areas. Runoff from DCIA areas is calculated as the rainfall-initial abstraction, while runoff from non-DCIA areas is calculated using a curve number value. A non-DCIA curve number reflects the area-weighted composite curve number for the land use and soil type combined with impervious areas that are not considered to be DCIA. Non-DCIA curve numbers were calculated for each land use category and sub-basin area in the Marco Island sub-basins under existing conditions, and appear to be on the lower end of the range of potential CN values for many of the drainage basin areas due to the highly permeable soils within the sub-basin areas.

3.10.4 Summary

A tabular summary of hydrologic characteristics of the land use categories in the Marco Island drainage basin under current conditions is given in Table 3-15. This information is used to develop estimates of runoff generated hydrologic inputs to Marco Island. The values summarized in this table do not include waterbodies or stormwater treatment systems referred to as “Dry Ponds, Ponds, and Wet Ponds” on Figure 3-2, since the BMP efficiency calculations conducted by ERD already include the volumetric and mass loadings which fall on the stormwater management systems. Therefore, the sum of the land use areas provided in Table 3-15 exclude the identified stormwater management systems and the sum of the treated and non-treated areas do not equal the total watershed area of 5,366.68 acres.

Overall, the Marco Island drainage basin has an average impervious percentage of approximately 41.0%. However, since much of the area is drained by grassed roadside swales, the DCIA within the drainage basin is only 1.6%.

TABLE 3-15
HYDROLOGIC CHARACTERISTICS
OF THE MARCO ISLAND DRAINAGE BASIN

| LAND USE | AREA (acres) | IMPERVIOUS AREA (acres) | IMPERVIOUS (% of Total) | DCIA AREA (acres) | PERCENT DCIA (%) | NON-DCIA CN VALUE |
|----------------------------|-------------------------|--|------------------------------------|----------------------------------|---------------------------------|------------------------------|
| Cemeteries | 3.27 | 0.37 | 11.2 | 0.00 | 0.0 | 45.6 |
| Coastal Scrub | 154.62 | 0.00 | 0.0 | 0.00 | 0.0 | 53.7 |
| Commercial | 332.56 | 247.49 | 74.4 | 66.52 | 26.9 | 79.1 |
| High-Density Residential | 9.68 | 4.94 | 51.0 | 2.33 | 47.1 | 59.9 |
| Highway | 12.71 | 10.11 | 79.5 | 4.77 | 47.2 | 78.7 |
| Institutional | 89.28 | 40.33 | 45.2 | 0.73 | 1.8 | 65.4 |
| Mangrove Swamps | 295.54 | 0.00 | 0.0 | 0.00 | 0.0 | 87.0 |
| Marinas | 4.72 | 2.75 | 58.3 | 0.00 | 0.0 | 73.4 |
| Medium-Density Residential | 3105.97 | 1455.53 | 46.9 | 0.84 | 0.1 | 66.6 |
| Multi-Family | 579.64 | 356.94 | 61.6 | 10.18 | 2.9 | 74.9 |
| Recreational | 199.14 | 29.49 | 14.8 | 1.24 | 4.2 | 47.4 |
| Saltwater Marshes | 14.37 | 0.00 | 0.0 | 0.00 | 0.0 | 98.0 |
| Scrub and Brushland | 12.17 | 0.00 | 0.0 | 0.00 | 0.0 | 74.3 |
| Swimming Beach | 282.97 | 0.00 | 0.0 | 0.00 | 0.0 | 77.0 |
| Tidal Flats | 41.66 | 0.00 | 0.0 | 0.00 | 0.0 | 98.0 |
| Upland Hardwood Forests | 82.29 | 0.00 | 0.0 | 0.00 | 0.0 | 41.4 |
| Utilities | 22.83 | 17.87 | 78.3 | 0.00 | 0.0 | 85.2 |
| Vacant Land | 14.15 | 0.00 | 0.0 | 0.00 | 0.0 | 39.0 |
| Grand Total | 5,257.56 | 2,165.81 | 41.2 | 86.60 | 1.6 | 69.2 |

SECTION 4

HYDROLOGIC INPUTS AND LOSSES

Average annual hydrologic budgets were developed for the waterways associated with Sub-basins 1-5, as summarized in Table 3-3, which include inputs from direct precipitation, stormwater runoff, irrigation, and groundwater seepage. Hydrologic losses are calculated for evaporation and outflow to adjacent tidal waterbodies. The hydrologic budget is used as input for development of nutrient budgets as well as estimation of hydraulic residence times within the waterways.

A conceptual schematic of evaluated hydrologic inputs and losses in Marco Island waterways is given on Figure 4-1. A discussion of identified hydrologic inputs and losses for Marco Island waterways is given in the following sections.

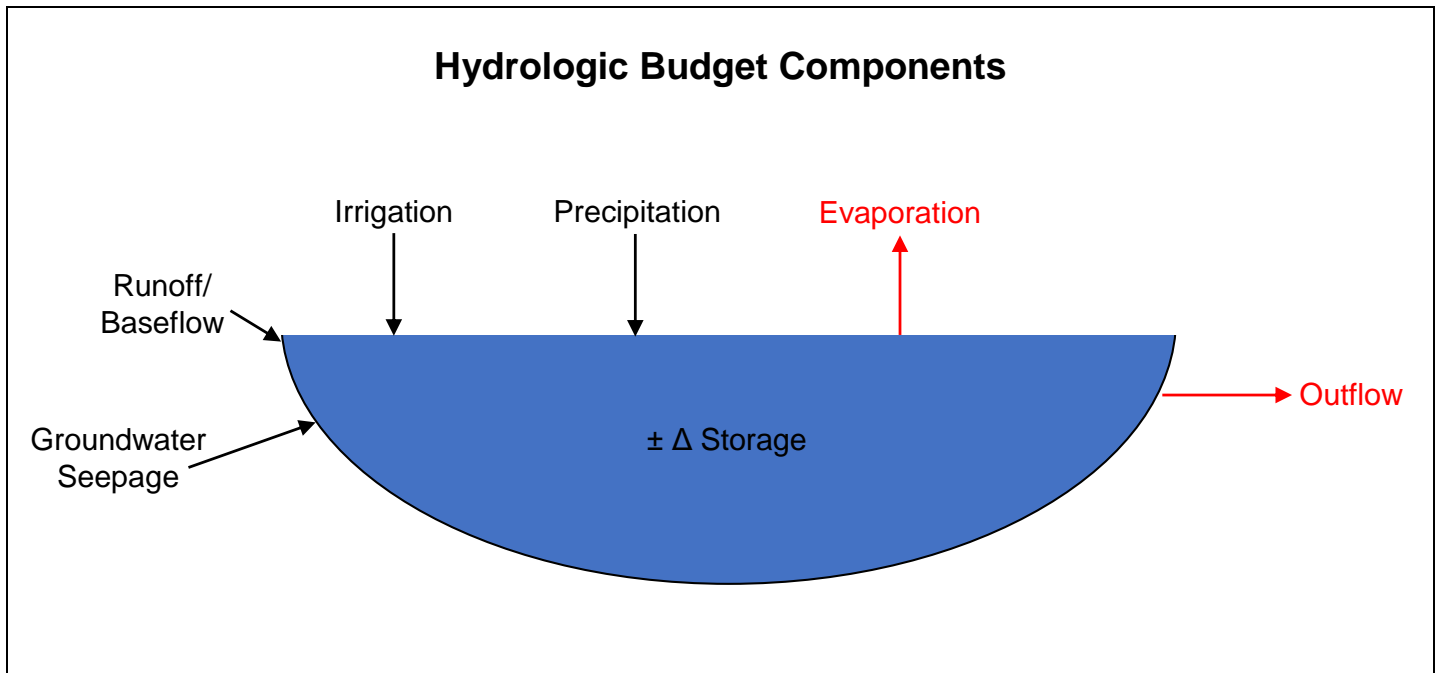

Figure 4-1. Conceptual Schematic of Evaluated Hydrologic Inputs and Losses to Marco Island Waterways.

4.1 Hydrologic Inputs

4.1.1 Direct Precipitation

4.1.1.1 Rainfall Events During the Field Monitoring Program

Hydrologic instrumentation was installed by ERD in the southern portion of the island at the Marco Island water treatment facility near the intersection of S. Heathwood Dr. and Lily Ct. to provide information on the characteristics of rainfall events which occurred during the field monitoring program and collect samples of bulk precipitation for nutrient analyses. The location of the hydrologic monitoring site is shown on Figure 4-2a.

A photograph of the hydrologic instrumentation installed at the site is given on Figure 4-2b. Rainfall was monitored using an ISCO Model 674 tipping bucket rain gauge which was attached to a 4-inch x 4-inch wooden post. The rainfall recorder produced a continuous record of all rainfall which occurred at the site, with a resolution of 0.01 inch. Rainfall data were stored inside a digital storage device (Hobo Event Rainfall Logger) which was also attached to the wooden post inside a waterproof enclosure. The rainfall record was used to provide information on general rainfall characteristics during the field monitoring program from May-November 2020. A manual rain gauge was also installed at the site to corroborate rainfall records provided by the recording rain gauge.

In addition to the tipping bucket rain gauge and manual rain gauge, a bulk precipitation collector and pan evaporimeter were also installed at the site, as indicated on Figure 4-2b. However, the evaporation data are not used for this project since the monitoring program covered only a portion of an annual cycle.

A summary of individual rain events monitored at the hydrologic monitoring site from May 1-November 30, 2020 is given in Table 4-1. Overall, a total of 49.80 inches of rainfall was recorded at the site during this period from 102 individual rain events ranging from 0.01-5.41 inches, with an average event rainfall of 0.44 inches. Rain event durations ranged from 0.02-26.66 days, with antecedent dry conditions between rain events ranging from 0.25-7.97 days.

A comparison of measured rainfall from May-November 2020 with typical “normal” rainfall is given in Table 4-2, with a graphical comparison provided in Figure 4-3. “Normal” rainfall is based on mean monthly rainfall recorded at the Marco Island meteorological monitoring site (USC00085359) over the 30-year period from 1991-2020 which is located near the maintenance facility at the Marco Island golf course.

During the field monitoring program, a total of 49.80 inches of rainfall were recorded compared with a “normal” rainfall of 42.65 inches for the months of May-November. Therefore, rainfall during the field monitoring program was approximately 17% above normal for this period. Higher than “normal” rainfall was measured during May, June, July, September, and November, with below “normal” rainfall during the remaining months.

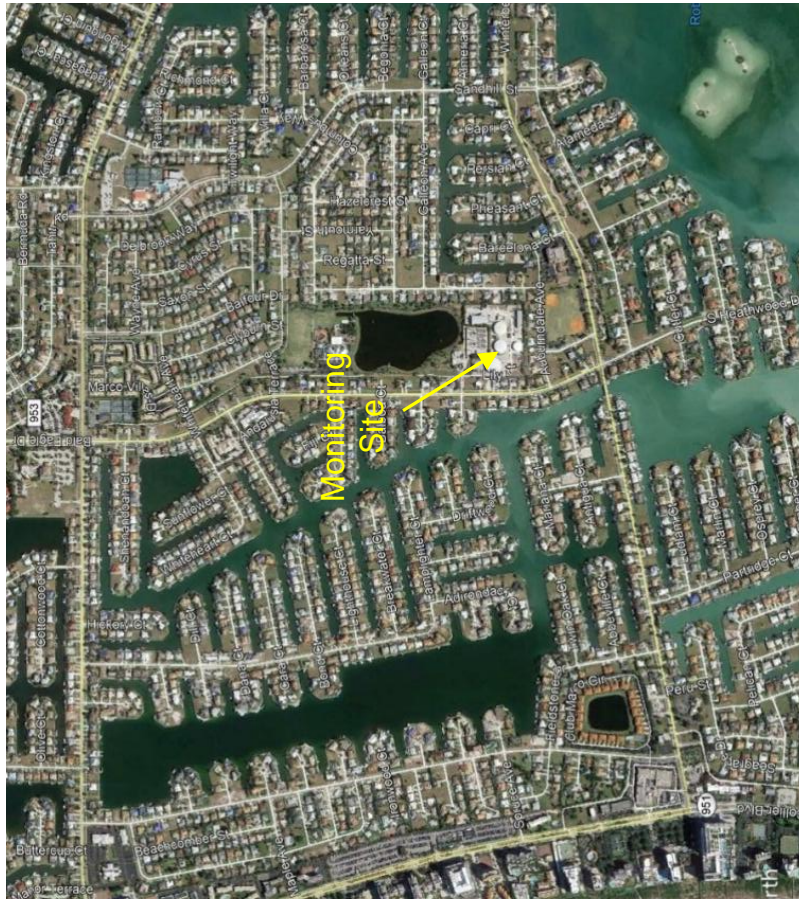

a. Hydrologic Monitoring Site Location



b. Hydrologic Instrumentation

Figure 4-2. Marco Island Hydrologic Instrumentation.

TABLE 4-1
MEASURED RAINFALL AT THE MARCO ISLAND
MONITORING SITE FROM MAY 1 – NOVEMBER 30, 2020

| EVENT START DATE | | EVENT END DATE | | EVENT RAINFALL (inches) | EVENT DURATION (hours) | ANTECEDENT DRY PERIOD (days) | AVERAGE INTENSITY (in/hr) |
|------------------|-------|----------------|-------|-------------------------|------------------------|------------------------------|---------------------------|
| Date | Time | Date | Time | | | | |
| 5/7/20 | 12:35 | 5/7/20 | 12:35 | 0.01 | --- | --- | --- |
| 5/10/20 | 7:39 | 5/10/20 | 12:29 | 0.06 | 4.83 | 2.79 | 0.01 |
| 5/10/20 | 21:44 | 5/10/20 | 21:44 | 0.01 | --- | --- | --- |
| 5/14/20 | 9:59 | 5/14/20 | 9:59 | 0.01 | --- | --- | --- |
| 5/15/20 | 8:59 | 5/15/20 | 14:59 | 0.07 | 6.00 | 0.96 | 0.01 |
| 5/18/20 | 18:09 | 5/18/20 | 19:44 | 1.29 | 1.58 | 3.13 | 0.81 |
| 5/19/20 | 2:59 | 5/19/20 | 5:49 | 0.51 | 2.83 | 0.30 | 0.18 |
| 5/19/20 | 14:09 | 5/19/20 | 14:19 | 0.07 | 0.17 | 0.35 | 0.42 |
| 5/23/20 | 12:39 | 5/23/20 | 16:04 | 0.83 | 3.42 | 3.93 | 0.24 |
| 5/24/20 | 6:44 | 5/24/20 | 6:44 | 0.01 | --- | --- | --- |
| 5/24/20 | 14:39 | 5/25/20 | 3:39 | 0.28 | 13.00 | 0.33 | 0.02 |
| 5/28/20 | 11:49 | 5/28/20 | 11:49 | 0.01 | --- | --- | --- |
| 5/28/20 | 22:29 | 5/28/20 | 22:29 | 0.01 | --- | --- | --- |
| 5/29/20 | 17:14 | 5/30/20 | 0:39 | 0.57 | 7.42 | 0.78 | 0.08 |
| 5/30/20 | 14:59 | 5/30/20 | 22:24 | 0.71 | 7.42 | 0.60 | 0.10 |
| 6/1/20 | 18:51 | 6/1/20 | 21:22 | 3.41 | 2.52 | 1.85 | 1.35 |
| 6/2/20 | 12:25 | 6/2/20 | 21:10 | 3.71 | 8.75 | 0.63 | 0.42 |
| 6/3/20 | 12:50 | 6/3/20 | 19:37 | 0.54 | 6.78 | 0.65 | 0.08 |
| 6/4/20 | 5:41 | 6/4/20 | 5:41 | 0.01 | --- | --- | --- |
| 6/4/20 | 13:53 | 6/4/20 | 21:05 | 2.07 | 7.20 | 0.34 | 0.29 |
| 6/5/20 | 12:49 | 6/5/20 | 15:20 | 0.21 | 2.52 | 0.66 | 0.08 |
| 6/5/20 | 21:24 | 6/6/20 | 10:08 | 0.44 | 12.73 | 0.25 | 0.03 |
| 6/6/20 | 21:19 | 6/7/20 | 4:19 | 0.23 | 7.00 | 0.47 | 0.03 |
| 6/9/20 | 12:19 | 6/9/20 | 12:19 | 0.01 | --- | --- | --- |
| 6/11/20 | 13:40 | 6/11/20 | 17:00 | 0.65 | 3.34 | 2.06 | 0.19 |
| 6/13/20 | 17:19 | 6/13/20 | 17:19 | 0.01 | --- | --- | --- |
| 6/14/20 | 15:08 | 6/14/20 | 15:47 | 0.41 | 0.64 | 0.91 | 0.64 |
| 6/15/20 | 20:11 | 6/15/20 | 20:51 | 0.36 | 0.66 | 1.18 | 0.54 |
| 6/16/20 | 7:39 | 6/16/20 | 7:39 | 0.01 | --- | --- | --- |
| 6/17/20 | 16:35 | 6/17/20 | 20:52 | 0.48 | 4.28 | 1.37 | 0.11 |
| 6/18/20 | 9:07 | 6/18/20 | 13:15 | 0.16 | 4.14 | 0.51 | 0.04 |
| 6/19/20 | 12:06 | 6/19/20 | 13:00 | 0.06 | 0.90 | 0.95 | 0.07 |
| 6/21/20 | 7:09 | 6/21/20 | 7:09 | 0.01 | --- | --- | --- |
| 6/26/20 | 14:35 | 6/26/20 | 14:39 | 0.04 | 0.07 | 5.31 | 0.57 |
| 6/27/20 | 23:24 | 6/27/20 | 23:24 | 0.01 | --- | --- | --- |

TABLE 4-1 -- CONTINUED

**MEASURED RAINFALL AT THE MARCO ISLAND
MONITORING SITE FROM MAY 1 – NOVEMBER 30, 2020**

| EVENT START DATE | | EVENT END DATE | | EVENT RAINFALL (inches) | EVENT DURATION (hours) | ANTECEDENT DRY PERIOD (days) | AVERAGE INTENSITY (in/hr) |
|---------------------|-------|-------------------|-------|-------------------------------|------------------------------|------------------------------------|---------------------------------|
| Date | Time | Date | Time | | | | |
| 7/5/20 | 22:48 | 7/6/20 | 13:22 | 1.03 | 14.56 | 7.97 | 0.07 |
| 7/12/20 | 11:51 | 7/12/20 | 17:31 | 1.81 | 5.66 | 5.94 | 0.32 |
| 7/15/20 | 14:15 | 7/15/20 | 14:15 | 0.01 | --- | --- | --- |
| 7/16/20 | 14:18 | 7/16/20 | 18:53 | 0.08 | 4.58 | 1.00 | 0.02 |
| 7/17/20 | 13:07 | 7/17/20 | 17:05 | 0.48 | 3.96 | 0.76 | 0.12 |
| 7/17/20 | 23:29 | 7/18/20 | 0:14 | 0.05 | 0.75 | 0.27 | 0.07 |
| 7/19/20 | 13:44 | 7/19/20 | 16:25 | 2.41 | 2.69 | 1.56 | 0.90 |
| 7/20/20 | 0:00 | 7/20/20 | 0:00 | 0.01 | --- | --- | --- |
| 7/20/20 | 14:21 | 7/20/20 | 19:27 | 0.48 | 5.11 | 0.60 | 0.09 |
| 7/21/20 | 11:42 | 7/21/20 | 12:43 | 0.12 | 1.01 | 0.68 | 0.12 |
| 7/22/20 | 1:10 | 7/22/20 | 7:10 | 0.06 | 6.01 | 0.52 | 0.01 |
| 7/22/20 | 16:56 | 7/22/20 | 17:32 | 0.03 | 0.61 | 0.41 | 0.05 |
| 7/23/20 | 13:32 | 7/23/20 | 21:32 | 0.87 | 8.00 | 0.83 | 0.11 |
| 7/24/20 | 21:31 | 7/25/20 | 0:16 | 0.21 | 2.75 | 1.00 | 0.08 |
| 7/25/20 | 8:05 | 7/25/20 | 8:05 | 0.01 | --- | --- | --- |
| 7/25/20 | 14:20 | 7/25/20 | 16:48 | 0.32 | 2.46 | 0.26 | 0.13 |
| 7/27/20 | 19:08 | 7/27/20 | 22:16 | 0.02 | 3.14 | 2.10 | 0.01 |
| 7/31/20 | 15:39 | 7/31/20 | 17:32 | 0.80 | 1.88 | 3.72 | 0.42 |
| 8/1/20 | 14:56 | 8/1/20 | 20:15 | 0.02 | 5.32 | 0.89 | 0.00 |
| 8/5/20 | 8:24 | 8/5/20 | 10:58 | 0.68 | 2.57 | 3.51 | 0.26 |
| 8/5/20 | 21:07 | 8/5/20 | 21:11 | 0.02 | 0.07 | 0.42 | 0.27 |
| 8/7/20 | 14:01 | 8/7/20 | 21:08 | 0.50 | 7.12 | 1.70 | 0.07 |
| 8/8/20 | 15:18 | 8/8/20 | 20:59 | 0.15 | 5.68 | 0.76 | 0.03 |
| 8/9/20 | 9:14 | 8/9/20 | 14:17 | 0.61 | 5.06 | 0.51 | 0.12 |
| 8/13/20 | 19:30 | 8/13/20 | 20:17 | 0.06 | 0.78 | 4.22 | 0.08 |
| 8/17/20 | 5:19 | 8/17/20 | 11:17 | 0.83 | 5.96 | 3.38 | 0.14 |
| 8/18/20 | 7:42 | 8/18/20 | 8:06 | 0.08 | 0.40 | 0.85 | 0.20 |
| 8/19/20 | 0:35 | 8/19/20 | 1:25 | 0.95 | 0.84 | 0.69 | 1.13 |
| 8/19/20 | 9:11 | 8/19/20 | 10:46 | 0.32 | 1.59 | 0.32 | 0.20 |
| 8/20/20 | 17:19 | 8/20/20 | 23:42 | 0.37 | 6.39 | 1.27 | 0.06 |
| 8/21/20 | 7:30 | 8/21/20 | 7:30 | 0.01 | --- | --- | --- |
| 8/21/20 | 22:18 | 8/21/20 | 23:02 | 0.65 | 0.73 | 0.62 | 0.90 |
| 8/22/20 | 11:04 | 8/22/20 | 11:49 | 0.03 | 0.75 | 0.50 | 0.04 |
| 8/22/20 | 18:01 | 8/22/20 | 18:01 | 0.01 | --- | --- | --- |
| 8/23/20 | 7:04 | 8/23/20 | 7:04 | 0.01 | --- | --- | --- |
| 8/24/20 | 9:37 | 8/24/20 | 12:39 | 0.20 | 3.04 | 1.11 | 0.07 |
| 8/26/20 | 15:11 | 8/26/20 | 21:02 | 0.33 | 5.85 | 2.11 | 0.06 |
| 8/28/20 | 13:07 | 8/28/20 | 13:47 | 0.03 | 0.66 | 1.67 | 0.05 |
| 8/30/20 | 22:58 | 8/30/20 | 22:59 | 0.02 | 0.02 | 2.38 | 1.00 |

TABLE 4-1 -- CONTINUED

**MEASURED RAINFALL AT THE MARCO ISLAND
MONITORING SITE FROM MAY 1 – NOVEMBER 30, 2020**

| EVENT START DATE | | EVENT END DATE | | EVENT RAINFALL (inches) | EVENT DURATION (hours) | ANTECEDENT DRY PERIOD (days) | AVERAGE INTENSITY (in/hr) |
|-----------------------|-------|-------------------|-------|-------------------------------|------------------------------|------------------------------------|---------------------------------|
| Date | Time | Date | Time | | | | |
| 9/1/20 | 17:18 | 9/1/20 | 17:53 | 0.34 | 0.58 | 1.76 | 0.58 |
| 9/4/20 | 17:03 | 9/4/20 | 19:14 | 0.08 | 2.18 | 2.97 | 0.04 |
| 9/5/20 | 15:24 | 9/5/20 | 17:51 | 0.61 | 2.46 | 0.84 | 0.25 |
| 9/6/20 | 13:03 | 9/6/20 | 18:10 | 0.50 | 5.12 | 0.80 | 0.10 |
| 9/7/20 | 5:49 | 9/7/20 | 5:49 | 0.01 | --- | --- | --- |
| 9/9/20 | 1:58 | 9/9/20 | 20:20 | 1.40 | 18.37 | 1.84 | 0.08 |
| 9/10/20 | 11:13 | 9/10/20 | 19:21 | 0.91 | 8.14 | 0.62 | 0.11 |
| 9/11/20 | 16:04 | 9/11/20 | 17:16 | 0.77 | 1.20 | 0.86 | 0.64 |
| 9/12/20 | 12:05 | 9/13/20 | 14:45 | 5.41 | 26.66 | 0.78 | 0.20 |
| 9/14/20 | 6:02 | 9/14/20 | 12:00 | 0.49 | 5.97 | 0.64 | 0.08 |
| 9/21/20 | 14:03 | 9/21/20 | 16:00 | 0.08 | 1.95 | 7.09 | 0.04 |
| 9/28/20 | 9:48 | 9/28/20 | 9:48 | 0.01 | --- | --- | --- |
| 9/29/20 | 4:54 | 9/29/20 | 13:05 | 0.47 | 8.19 | 0.80 | 0.06 |
| 10/2/20 | 9:26 | 10/2/20 | 23:47 | 0.25 | 14.34 | 2.85 | 0.02 |
| 10/3/20 | 17:46 | 10/3/20 | 21:04 | 0.11 | 3.29 | 0.75 | 0.03 |
| 10/4/20 | 3:10 | 10/4/20 | 5:08 | 0.04 | 1.97 | 0.25 | 0.02 |
| 10/4/20 | 14:08 | 10/4/20 | 14:32 | 0.23 | 0.40 | 0.38 | 0.57 |
| 10/6/20 | 17:28 | 10/6/20 | 19:40 | 0.09 | 2.19 | 2.12 | 0.04 |
| 10/9/20 | 20:01 | 10/9/20 | 20:03 | 0.06 | 0.04 | 3.01 | 1.59 |
| 10/12/20 | 4:09 | 10/12/20 | 4:14 | 0.03 | 0.08 | 2.34 | 0.38 |
| 10/12/20 | 11:26 | 10/12/20 | 11:26 | 0.01 | --- | --- | --- |
| 10/16/20 | 15:49 | 10/16/20 | 16:02 | 0.20 | 0.23 | 4.18 | 0.87 |
| 10/19/20 | 9:29 | 10/19/20 | 11:21 | 0.21 | 1.87 | 2.73 | 0.11 |
| 10/19/20 | 20:18 | 10/19/20 | 20:18 | 0.01 | --- | --- | --- |
| 10/20/20 | 10:58 | 10/20/20 | 14:14 | 0.02 | 3.26 | 0.61 | 0.01 |
| 10/21/20 | 14:04 | 10/21/20 | 15:13 | 0.10 | 1.16 | 0.99 | 0.09 |
| 10/24/20 | 16:40 | 10/24/20 | 17:01 | 0.33 | 0.36 | 3.06 | 0.93 |
| 10/25/20 | 9:51 | 10/25/20 | 22:57 | 0.46 | 13.11 | 0.70 | 0.04 |
| 10/26/20 | 16:54 | 10/26/20 | 23:18 | 0.21 | 6.40 | 0.75 | 0.03 |
| 10/31/20 | 14:43 | 10/31/20 | 17:25 | 0.41 | 2.70 | 4.64 | 0.15 |
| 11/5/20 | 16:02 | 11/5/20 | 19:39 | 0.33 | 3.63 | 4.94 | 0.09 |
| 11/7/20 | 1:25 | 11/7/20 | 1:34 | 0.02 | 0.15 | 1.24 | 0.13 |
| 11/7/20 | 18:42 | 11/7/20 | 23:51 | 0.14 | 5.15 | 0.71 | 0.03 |
| 11/8/20 | 11:09 | 11/9/20 | 13:37 | 2.52 | 26.47 | 0.47 | 0.10 |
| 11/11/20 | 2:35 | 11/11/20 | 13:20 | 0.49 | 10.74 | 1.54 | 0.05 |
| 11/14/20 | 15:06 | 11/14/20 | 15:06 | 0.01 | --- | --- | --- |
| 11/16/20 | 20:59 | 11/16/20 | 21:07 | 0.13 | 0.14 | 2.25 | 0.92 |
| 11/22/20 | 16:35 | 11/22/20 | 17:12 | 0.15 | 0.62 | 5.81 | 0.24 |
| 11/30/20 | 15:23 | 11/30/20 | 23:25 | 0.20 | 8.05 | 7.92 | 0.02 |
| Minimum Value: | | | | 0.01 | 0.02 | 0.25 | 0.00 |
| Maximum Value: | | | | 5.41 | 26.66 | 7.97 | 1.59 |
| Mean Value: | | | | 0.44 | 4.57 | 1.76 | 0.25 |

TABLE 4-2

**COMPARISON OF FIELD MEASURED RAINFALL
AND “NORMAL” RAINFALL FROM MAY-NOVEMBER 2020**

| MONTH | RAINFALL (inches) | |
|---------------|-------------------|-------------------|
| | Measured (2020) | 1991-2020 Normals |
| May | 4.45 | 3.38 |
| June | 12.83 | 8.36 |
| July | 8.80 | 6.60 |
| August | 5.88 | 9.16 |
| September | 11.08 | 9.92 |
| October | 2.77 | 3.21 |
| November | 3.99 | 2.02 |
| TOTAL: | 49.80 | 42.65 |

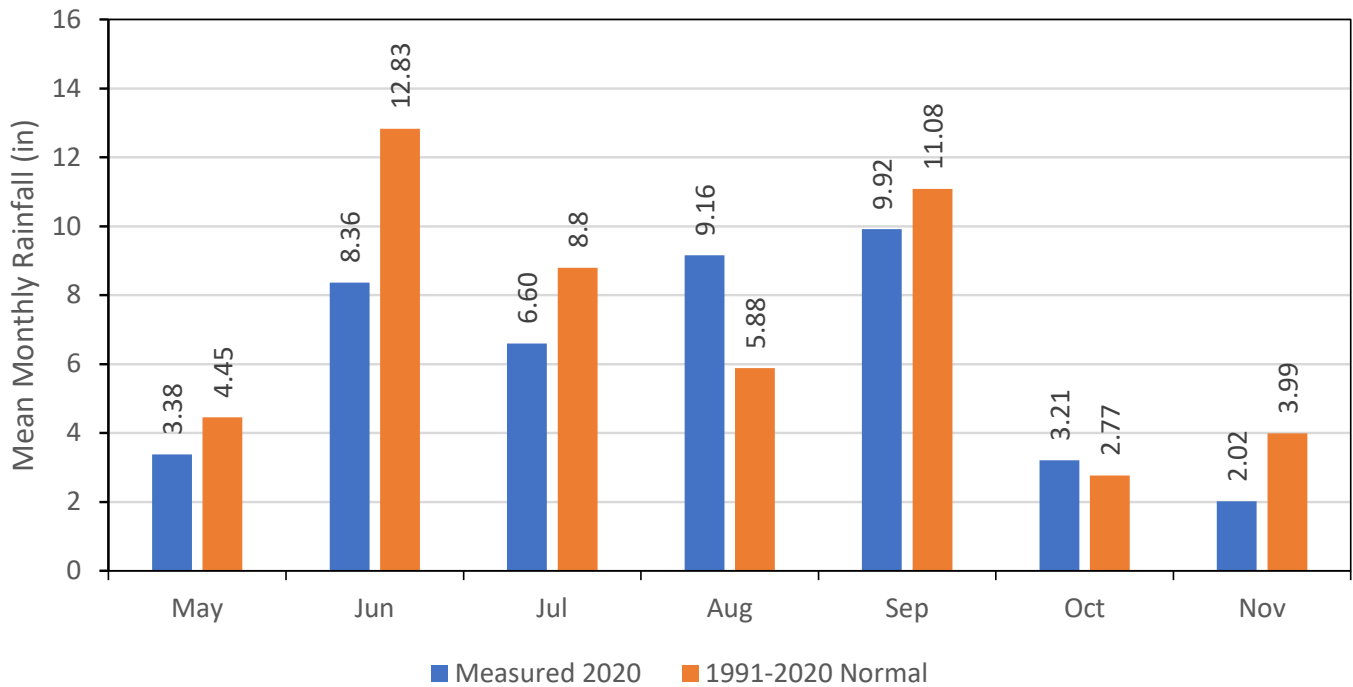

Figure 4-3. Graphical Comparison of Field Measured and “Normal” Rainfall from May-November 2020.

4.1.1.2 Historical Rainfall Characteristics

For purposes of developing the average annual hydrologic budgets, hydrologic inputs from direct precipitation to Marco Island waterways are calculated based upon historical mean monthly precipitation measured at the Marco Island meteorological site from 1991-2020. A summary of mean monthly rainfall at the Marco Island meteorological station from 1991-2020 is given in Table 4-3. Mean monthly rainfall depths range from a low of 1.91 inches during February to a high of 9.92 inches in September, with an annual total of approximately 53.30 inches. The monthly rainfall amounts summarized in Table 4-3 are assumed to be similar to rainfall which occurs on an annual basis on Marco Island.

TABLE 4-3

SUMMARY OF MEAN MONTHLY RAINFALL AT THE MARCO ISLAND METEOROLOGICAL SITE (USC00085359) FROM 1991-2020

| MONTH | RAINFALL DEPTH (inches) | MONTH | RAINFALL DEPTH (inches) | MONTH | RAINFALL DEPTH (inches) |
|----------|----------------------------|--------|----------------------------|---------------|----------------------------|
| January | 2.50 | May | 3.38 | September | 9.92 |
| February | 1.91 | June | 8.36 | October | 3.21 |
| March | 2.05 | July | 6.60 | November | 2.02 |
| April | 2.48 | August | 9.16 | December | 1.71 |
| | | | | TOTAL: | 53.30 |

4.1.1.2.1 Annual Hydrologic Inputs

Estimated monthly hydrologic inputs to Marco Island waterways from direct precipitation were calculated by multiplying the mean monthly rainfall measured at the Marco Island meteorological monitoring site (as summarized in Table 4-3) times the waterway surface areas summarized in Table 3-3. A summary of estimated mean monthly hydrologic inputs to Marco Island waterways from direct precipitation is given in Table 4-4. During an average annual rainfall year, direct precipitation contributes from 336.0-2,511.8 ac-ft to the 5 sub-basin waterways.

TABLE 4-4
MEAN MONTHLY PRECIPITATION
INPUTS TO MARCO ISLAND WATERWAYS

| MONTH | MEAN RAINFALL (inches) ¹ | MONTHLY PRECIPITATION INPUTS (ac-ft) | | | | |
|---------------|---|--------------------------------------|---------------------------|----------------------------|----------------------------|----------------------------|
| | | Sub-basin 1 (565.61 ac) | Sub-basin 2 (75.65 ac) | Sub-basin 3 (227.87 ac) | Sub-basin 4 (374.28 ac) | Sub-basin 5 (281.65 ac) |
| January | 2.50 | 117.8 | 15.8 | 47.5 | 78.0 | 58.7 |
| February | 1.91 | 90.0 | 12.0 | 36.3 | 59.6 | 44.8 |
| March | 2.05 | 96.6 | 12.9 | 38.9 | 63.9 | 48.1 |
| April | 2.48 | 116.9 | 15.6 | 47.1 | 77.4 | 58.2 |
| May | 3.38 | 159.3 | 21.3 | 64.2 | 105.4 | 79.3 |
| June | 8.36 | 394.0 | 52.7 | 158.7 | 260.7 | 196.2 |
| July | 6.60 | 311.0 | 41.6 | 125.3 | 205.9 | 154.9 |
| August | 9.16 | 431.7 | 57.7 | 173.9 | 285.7 | 215.0 |
| September | 9.92 | 467.5 | 62.5 | 188.4 | 309.4 | 232.8 |
| October | 3.21 | 151.3 | 20.2 | 61.0 | 100.1 | 75.3 |
| November | 2.02 | 95.2 | 12.7 | 38.4 | 63.0 | 47.4 |
| December | 1.71 | 80.6 | 10.8 | 32.5 | 53.3 | 40.1 |
| TOTAL: | 53.30 | 2,511.8 | 336.0 | 1,012.1 | 1,662.4 | 1,251.0 |

1. Mean monthly precipitation at the Marco Island meteorological site from 1991-2020

4.1.2 Stormwater Runoff

Estimates of hydrologic inputs to Marco Island waterways from stormwater runoff were calculated for Sub-basin areas 1-5 using an average annual rainfall of 53.30 inches and runoff calculations based upon measured historical rain event characteristics. Individual estimates of runoff inputs were generated for each of the sub-basin areas discharging to Marco Island waterways which are used for development of both hydrologic and nutrient budgets. Details of evaluation methods and results of the runoff modeling efforts are given in the following sections.

4.1.2.1 Computational Methods

Estimates of volumetric inputs from direct stormwater runoff were generated for Sub-basins 1-5 using the methodology developed by Harper and Baker (2007) for FDEP as part of the Statewide Stormwater Rule process during 2010. The estimated runoff volumes were calculated for average annual rainfall conditions based upon hydrologic modeling of individual rain events measured in the South Florida area over the period from 1942-2010.

The standard SCS model calculates runoff volumes using a weighted CN value for each land use type present in the sub-basin area. However, the relationship between CN values and runoff volumes is an exponential function, and large errors in runoff estimation can occur by averaging CN values, especially if the values are widely different in magnitude. To reduce this error, ERD developed a modification to the standard SCS CN model which reduces the need to average CN values by calculating separate runoff volumes for DCIA and non-DCIA portions of each sub-basin. Under this modified approach, the runoff volume for each rainfall event is calculated by adding the rainfall excess from the non-directly connected impervious area (non-DCIA) portion to the rainfall excess created from the DCIA portion for the basin. Rainfall excess from the non-DCIA areas is calculated using the following set of equations:

$$\text{Soil Storage } (S) = \frac{1000}{nDCIA \text{ CN}} - 10$$

$$nDCIA \text{ CN} = \frac{[CN * (100 - IMP)] + [98 (IMP - DCIA)]}{(100 - DCIA)}$$

$$Q_{nDCIAi} = \frac{(P_i - 0.2S)^2}{(P_i + 0.8S)}$$

where:

| | | |
|--------------|---|--|
| CN | = | curve number for pervious area |
| IMP | = | percent impervious area |
| DCIA | = | percent directly connected impervious area |
| nDCIA CN | = | curve number for non-DCIA area |
| P_i | = | rainfall event depth (inches) |
| Q_{nDCIAi} | = | rainfall excess for non-DCIA for rainfall event (inches) |

For the DCIA portion, rainfall excess is calculated using the following equation:

$$Q_{DCIAi} = (P_i - 0.1)$$

When P_i is less than 0.1, Q_{DCIAi} is equal to zero. This methodology is used to estimate the generated runoff volume within each of the delineated sub-basin areas for each rainfall event which occurred over the simulation period.

A continuous runoff simulation model was developed using the modified SCS Curve Number Methodology, and the available period of historical rainfall data for South Florida from 1942-2010 were used as the precipitation input data. Hydrologic characteristics of the Marco Island sub-basin areas were determined by ERD based upon aerial photography and a field reconnaissance of the watershed areas. This information was discussed previously in Section 3.10, and detailed hydrologic characteristics of the sub-basin areas by land use are provided in Table 3-15. This model is used to provide estimates of mean annual runoff volumes generated in each of the 5 sub-basins for measured rainfall events over the period from 1942-2010.

The methodology outlined above provides an estimate of the runoff volume “generated” from each of the individual rain events in each of the 5 sub-basins over the available period of record based upon a mean annual rainfall of 53.30 inches. The sum of the total generated runoff was then divided by the number of years in the historical record to obtain an estimate of the mean annual runoff volume.

The SCS model assumes that all generated runoff reaches the ultimate receiving water, but significant portions of the generated runoff volume may be attenuated by infiltration into swales, depressional areas, and in stormwater management systems within each sub-basin area. If the stormwater management system provides dry retention treatment, a large portion of the runoff volume may be infiltrating into the ground and not reach the receiving water as a surface flow. If the stormwater system provides wet detention treatment, a portion of the generated runoff volume may be lost due to evaporation within the pond or infiltration through the pond bottom.

The watershed runoff model includes information on the types of stormwater management systems utilized within each sub-basin area and the amount of developed area treated by each stormwater management type. The generated runoff volume discharging to stormwater treatment systems is reduced or attenuated for likely volumetric removal processes in the treatment system. Estimates of the amount of generated runoff volume attenuated by each type of stormwater management system and natural features, such as wetlands, are included in the model, and the attenuated volume is subtracted from the generated volume within each sub-basin. The result is an estimate of the runoff volume which actually discharges into the receiving waterbody from each sub-basin area.

A summary of estimated volumetric removal efficiencies for stormwater management systems and natural features in the Marco Island sub-basins is given in Table 4-5. These volumetric removals are based on previous hydrologic modeling of natural areas performed by ERD and extensive research on the performance efficiencies of stormwater management systems used in the State of Florida. Developed areas treated by dry retention are assumed to have a volumetric loss of approximately 80% for runoff inputs due to infiltration and evaporation within the pond, with a 20% volumetric reduction assumed for wet ponds. Runoff is also retained within drainage swales due to storage, infiltration, and evapotranspiration, with an assumed volumetric runoff reduction of 20%. The information summarized in Table 4-5 is combined with information on stormwater management systems and wetland areas (Figure 3-12) to assist in calculation of estimated runoff inflow from each sub-basin area.

TABLE 4-5

**ESTIMATED VOLUMETRIC REMOVAL EFFICIENCIES
FOR WETLANDS AND STORMWATER MANAGEMENT
SYSTEMS IN THE MARCO ISLAND DRAINAGE BASINS**

| SYSTEM TYPE | VOLUME REDUCTION (% of Annual Runoff) |
|--------------------|--|
| Dry Pond | 80 |
| Wet Pond | 20 |
| Drainage Swales | 20 |
| Rear Yard Drains | 95 |

According to Chapter 6, Article III, Division 2 of the Marco Island, Florida, Code of Ordinances, all properties which border salt waterbodies must have a seawall. To protect from build-up of water pressure behind the seawall, all properties with seawalls are required to install a French drain to intercept local groundwater and allow the pressure to be regulated by 2-inch weep holes in the seawall.

A photograph of a typical rear yard French drain is given on Figure 4-4a, and a schematic of construction details for the French drain is given on Figure 4-4b. Although the French drains are intended to regulate hydrostatic pressures on the seawall, the drains also serve to capture virtually all rear yard runoff from waterfront properties and infiltrate the runoff into groundwater. Since a rear yard discharge of runoff would require an extreme storm event, rear yard areas of homes adjacent to waterways with seawalls are assumed to infiltrate 95% of the generated runoff into groundwater.

The runoff models do not include runoff generation for any natural or man-made open waterbodies since the models are designed to estimate runoff on an average annual basis, and precipitation inputs and evaporation losses are approximately equal on an average annual basis. Dry ponds are also excluded from runoff generation calculations since rainfall on the pond surface is considered in the removal calculations. Wet stormwater ponds are excluded from the modeled runoff area for the same reason, although a volumetric reduction of 20% is assumed for runoff inputs entering wet detention ponds due to groundwater losses.

4.1.2.2 Modeled Runoff Volumes

Hydrologic modeling was conducted to estimate annual runoff inputs to Marco Island waterways using the methodology and assumptions discussed in previous sections. A discussion of runoff inputs to the waterways is given in the following sections. A summary of the hydrologic model used to calculate annual runoff volumes is given in Appendix D.

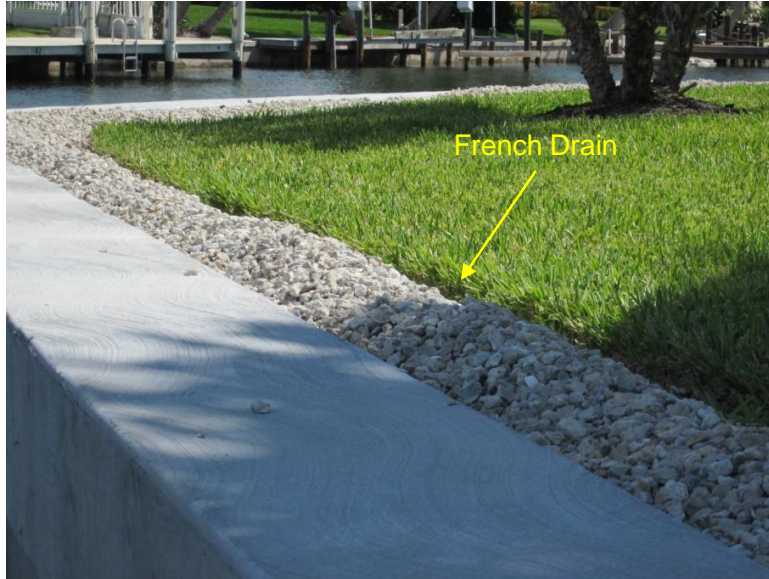

a. Photo of typical rear yard French drain

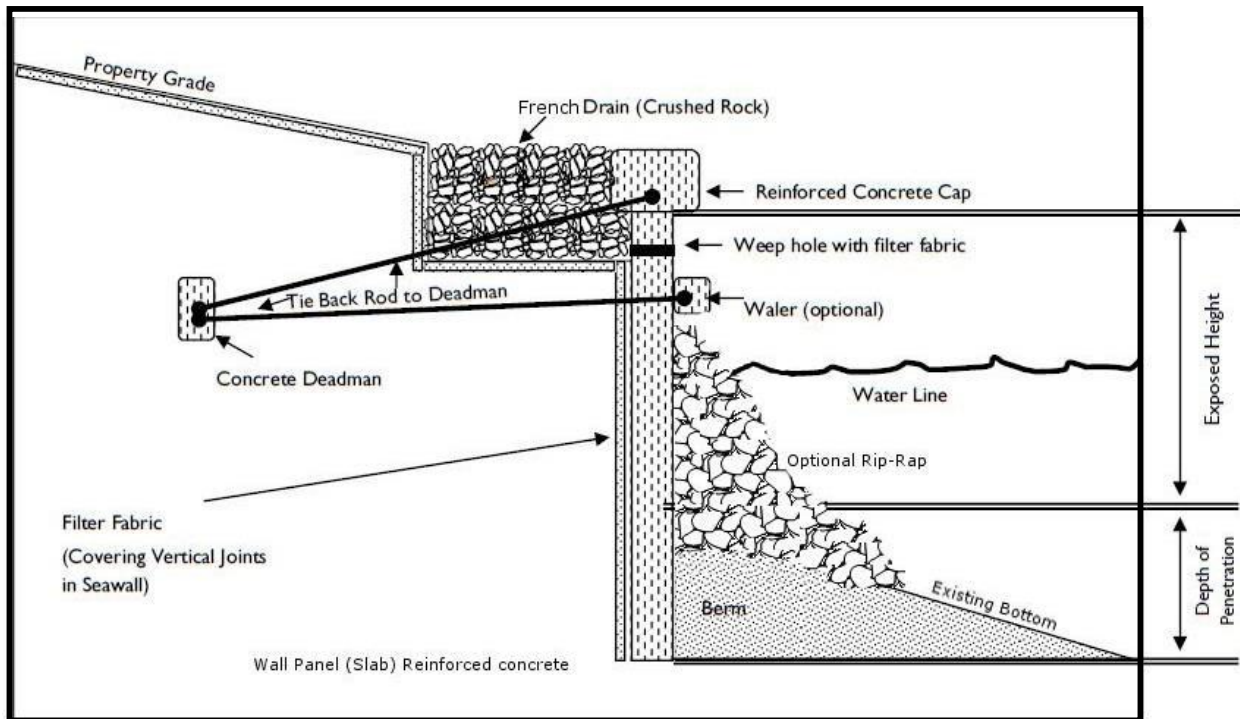

b. Schematic of typical rear yard French drain

Figure 4-4. Rear Yard French Drains.

A summary of estimated runoff volumes which discharge from each of the 5 modeled drainage sub-basin areas into Marco Island waterways on an average annual basis is given in Table 4-6. The generated runoff volume represents the modeled runoff volume within each sub-basin prior to volume reduction in stormwater management systems, wetlands, and ditches/swales. Estimates of the runoff volume removed in dry and wet ponds, swales, and wetlands are calculated for each sub-basin based upon the volumetric removal efficiencies summarized in Table 4-5, and subtracted from the generated runoff volume. The resulting values represent the observed mean annual runoff volume which is actually discharged to Marco Island waterways from each sub-basin. Estimates of the generated and observed runoff coefficients (C value) are also provided for each drainage sub-basin.

TABLE 4-6
SUMMARY OF GENERATED AND DELIVERED
RUNOFF VOLUMES FOR MARCO ISLAND SUB-BASIN AREAS

| BASIN | AREA (acres) | GENERATED RUNOFF VOLUME (ac-ft) | GENERATED C VALUE | RUNOFF ATTENUATION BY BMP (ac-ft/yr) | | | | | | DELIVERED RUNOFF VOLUME (ac-ft/yr) | DELIVERED C VALUE | |
|------------------------|-----------------|--|-------------------------|---|--------------|-------------|----------------|-------------|---------------|---|-------------------------|--------------|
| | | | | Dry Ponds | Swales | Wet Pond | Swale- Pond | Wetland | Rear Swale | | | Total |
| 1 | 1,469.4 | 620.8 | 0.095 | 63.0 | 69.0 | 1.6 | 0.02 | -- | 57.8 | 191.5 | 429.4 | 0.066 |
| 2 | 306.2 | 154.7 | 0.114 | 26.2 | 16.8 | 0.2 | 0.3 | -- | 16.9 | 60.3 | 94.3 | 0.069 |
| 3 | 895.5 | 252.4 | 0.063 | 15.7 | 23.8 | 7.3 | 8.7 | -- | 49.3 | 104.8 | 147.6 | 0.037 |
| 4 | 942.4 | 414.5 | 0.099 | 134.6 | 30.7 | 1.9 | -- | -- | 40.4 | 207.5 | 206.9 | 0.049 |
| 5 | 814.6 | 253.3 | 0.070 | 46.0 | 25.4 | 0.6 | 8.4 | 0.04 | 39.8 | 120.3 | 133.0 | 0.037 |
| Sub- Total: | 4,428.1 | 1,695.6 | 0.086 | 285.4 | 165.8 | 11.6 | 17.4 | 0.04 | 204.2 | 684.4 | 1,011.3 | 0.051 |
| 6 | 480.1 | 265.6 | 0.125 | -- | -- | -- | -- | -- | -- | 0.0 | 265.6 | 0.125 |
| 7 | 349.4 | 248.8 | 0.160 | 3.5 | 4.7 | 0.05 | -- | 0.3 | -- | 8.5 | 240.3 | 0.155 |
| Sub- Total: | 829.5 | 514.4 | 0.140 | 3.5 | 4.7 | 0.05 | 0.0 | 0.3 | 0.0 | 8.5 | 506.0 | 0.137 |

The generated and observed runoff coefficients are calculated as follows:

$$\text{Generated C Value} = \frac{\text{Generated Runoff Volume (ac-ft)}}{\text{Total Basin Area (ac)} \times \text{Rainfall Depth (ft)}}$$

$$\text{Observed C Value} = \frac{\text{Observed Runoff Volume (ac-ft)}}{\text{Total Basin Area (ac)} \times \text{Rainfall Depth (ft)}}$$

As indicated on Table 4-6, approximately 1,695.6 ac-ft/yr of runoff is generated in Marco Island Sub-basins 1-5, resulting in a generated runoff C Value of 0.086, indicating that approximately 8.6% of the annual rainfall volume becomes runoff. This relatively low annual C value is related to the highly permeable soils in the watershed which allow most of the rainfall to infiltrate into the soil before runoff can even be generated. Approximately 684.4 ac-ft/yr of the generated runoff volume is lost in stormwater management systems and ponds, with approximately 9.8% of the generated runoff infiltrated into roadside swales.

The runoff volume which actually reaches the waterways for Sub-basins 1-5 each year is approximately 1,011.3 ac-ft/yr which corresponds to a delivered runoff coefficient of 0.051, indicating that approximately 5.1% of the annual rainfall which occurs in the Marco Island watershed actually reaches adjacent waterways as stormwater runoff on an average annual basis. A runoff delivery coefficient in this range is on the lower end of values typically observed for developed watersheds containing large areas of highly permeable soils. Calculated generated runoff coefficients (C Values) for individual sub-basins range from 0.063-0.114, with delivered runoff coefficients ranging from 0.037-0.069.

As indicated on Table 4-6, the single largest contribution of runoff to Marco Island waterways originates within Sub-basin 1 which consists of a 1,469.4-acre area (excluding stormwater management facilities) of high-density residential, medium-density residential, commercial, institutional, and natural areas located in the northwest quadrant of Marco Island. This sub-basin contributes approximately 42.5% of the annual runoff inputs into adjacent waterways. An additional 20.5% of the annual runoff inputs originate from Sub-basin 4 which consists of approximately 942.4 acres of multi-family residential, medium-density residential, commercial, and highway land uses, excluding stormwater management facilities. The third most significant source of runoff inputs is Sub-basin 3 which contributes 14.6% of the annual runoff inflows. Each of the remaining sub-basin areas contributes approximately 13% or less of the total annual inputs to Marco Island waterways from stormwater runoff.

4.1.3 Irrigation Inputs

An analysis was conducted to estimate volumetric irrigation inputs to sub-basin areas in Marco Island. Irrigation application rates to areas receiving reuse irrigation are based on the average application rates for golf courses and other public access areas summarized in Table 3-12. Irrigation on all remaining pervious areas within the drainage basins which do not receive reuse irrigation is assumed to be 0.5 inch/week.

A summary of pervious and impervious areas in sub-basins with and without reuse irrigation is given in Table 4-7. Areas of golf courses and common areas which receive reuse irrigation are divided into impervious and pervious surfaces based on an independent analysis of areas receiving reuse irrigation. The total area of parcels receiving reuse irrigation, including both on- and off-island areas, is estimated by ERD to be 1,533.20 acres, based on the parcels included in the active reuse areas and discussions with City Public Works personnel. Of the 1,533.20 acres, only pervious surfaces receive reuse irrigation, with a combined area of 628.95 acres. Information is also provided on impervious and pervious areas for portions of the watershed which do not receive reuse irrigation. An additional 1,874.55 acres of pervious surfaces are irrigated using sources other than reuse.

TABLE 4-7

**PERVIOUS AND IMPERVIOUS AREAS IN SUB-BASINS
WITH AND WITHOUT REUSE IRRIGATION**

| AREA | SUB-BASIN | REUSE AREAS (acres) | | | | NON-REUSE AREAS (acres) | | TOTAL (acres) |
|---------------|--------------------------|---------------------|---------------|---------------|---------------|-------------------------|-----------------|----------------|
| | | Golf Courses | | Common Areas | | Impervious | Pervious | |
| | | Impervious | Pervious | Impervious | Pervious | | | |
| On-Island | 1 | 0.88 | 19.14 | 223.40 | 115.97 | 450.03 | 660.0 | 1,469.4 |
| | 2 | 0 | 0 | 30.84 | 8.68 | 143.11 | 123.54 | 306.2 |
| | 3 | 6.92 | 106.85 | 60.68 | 118.90 | 318.49 | 283.70 | 895.5 |
| | 4 | 0 | 0 | 204.30 | 90.87 | 289.22 | 357.98 | 942.4 |
| | 5 | 0 | 0 | 23.71 | 0.00 | 341.58 | 449.33 | 814.6 |
| Off-Island | 6 | 0 | 0 | 0.00 | 5.94 | -- | -- | -- |
| | Marco Shores Golf Course | 26.00 | 104.00 | 0.00 | 0.00 | -- | -- | -- |
| | Isles of Capri | 0 | 0 | 328.0 | 59.0 | -- | -- | -- |
| TOTAL: | | 33.80 | 229.99 | 870.93 | 398.96 | 1,542.43 | 1,874.55 | 4,428.1 |

A summary of annual reuse and non-reuse irrigation volumes by sub-basin is given in Table 4-8. Pervious golf course areas are assumed to be irrigated at an application rate of 0.56 inch/week (as summarized in Table 3-12), while pervious common areas irrigated with reuse are assumed to have an application rate of 0.88 inches/week (as indicated in Table 3-12). All areas which do not receive reuse irrigation are assumed to be irrigated at an average rate of 0.5 inch/week. The sum of the irrigated volumes in reuse and non-reuse areas is equal to the total irrigation volume applied in each of the 5 sub-basins on an average annual basis. Overall, irrigation provides an additional hydrologic input of approximately 5,643 ac-ft/yr to the 5 Marco Island sub-basin areas. This information is used in the next section to develop an overall hydrologic budget for groundwater seepage.

TABLE 4-8

ANNUAL REUSE AND NON-REUSE IRRIGATION VOLUMES BY SUB-BASIN

| SUB-BASIN | REUSE AREAS (acres) | | | | NON-REUSE AREAS (acres) | | TOTAL (ac-ft/yr) |
|---------------|---------------------|-------------------|--------------|-------------------|-------------------------|-------------------|------------------|
| | Golf Courses | | Common Areas | | Rate (in/wk) | Volume (ac-ft/yr) | |
| | Rate (in/wk) | Volume (ac-ft/yr) | Rate (in/wk) | Volume (ac-ft/yr) | | | |
| 1 | 0.56 | 46.4 | 0.88 | 442 | 0.50 | 1,430 | 1,919 |
| 2 | 0.56 | 0.0 | 0.88 | 33.1 | 0.50 | 268 | 301 |
| 3 | 0.56 | 259.3 | 0.88 | 453 | 0.50 | 615 | 1,327 |
| 4 | 0.56 | 0.0 | 0.88 | 347 | 0.50 | 776 | 1,122 |
| 5 | 0.56 | 0.0 | 0.88 | 0.0 | 0.50 | 974 | 974 |
| TOTAL: | -- | 305.7 | -- | 1,275 | -- | 4,063 | 5,643 |

4.1.4 Shallow Groundwater Seepage

Field investigations were performed by ERD to evaluate the quantity and quality of shallow groundwater seepage entering Marco Island waterbodies during the monitoring program. Groundwater seepage was quantified using a series of underwater seepage meters installed at selected locations throughout the various waterways. Seepage meters provide a mechanism for direct measurement of groundwater inflow into a waterbody by isolating a portion of the bottom so that groundwater seeping up through the bottom sediments into the surface water can be collected and characterized. Use of the direct seepage meter measurement technique avoids errors, assumptions, and extensive input data required when indirect techniques are used, such as the Gross Water Budget or Subtraction Method, as well as computer modeling and flow net analyses.

The seepage meter technique has been recommended by the U.S. Environmental Protection Agency (EPA) and has been established as an accurate and reliable technique in field and tank test studies (Lee, 1977; Erickson, 1981; Cherkauer and McBride, 1988; Belanger and Montgomery, 1992). With installation of adequate numbers of seepage meters and proper placement, seepage meters are a very effective tool to estimate groundwater-surface water interactions. One distinct advantage of seepage meters is that seepage meters can provide estimates of both water quantity and quality entering a lake system, whereas estimated methods can only provide information on water quantity.

4.1.4.1 Seepage Meter Construction and Locations

A schematic of a typical seepage meter installation used at Marco Island is given in Figure 4-5, and a generic photograph of seepage meters being prepared for deployment is given in Figure 4-6. Seepage meters were constructed from a 2-ft diameter aluminum cylinder with a closed top and open bottom. The seepage meters were inserted into the sediments to a depth of approximately 8-12 inches, isolating a sediment area of 3.14 ft². After installation, approximately 3-6 inches of water was trapped inside the seepage meter above the water-sediment interface.

A 0.75-inch PVC fitting was threaded into the top of each meter and attached to a female quick-disconnect PVC Camlock fitting. A flexible polyethylene bag, with an approximate volume of 40 gallons, was attached to the seepage meter using a quick-disconnect PVC male Camlock fitting with a terminal ball valve. Each of the collection bags was constructed of black polyethylene to prevent light penetration into the bag which could potentially stimulate photosynthetic activity within the sample prior to collection and result in an alteration of the chemical characteristics of the seepage sample.

Prior to attachment to the seepage meter, all air is removed from inside the polyethylene collection bag, and the PVC ball valve is closed so that water would not enter the collection container prior to attachment to the seepage meter. A diver then connects the collection bag to the seepage meter using the PVC camlock fitting. After attaching the collection bag to the seepage meter, the PVC ball valve is opened, and groundwater influx into the open bottom of the seepage meter is collected inside the flexible polyethylene bag.

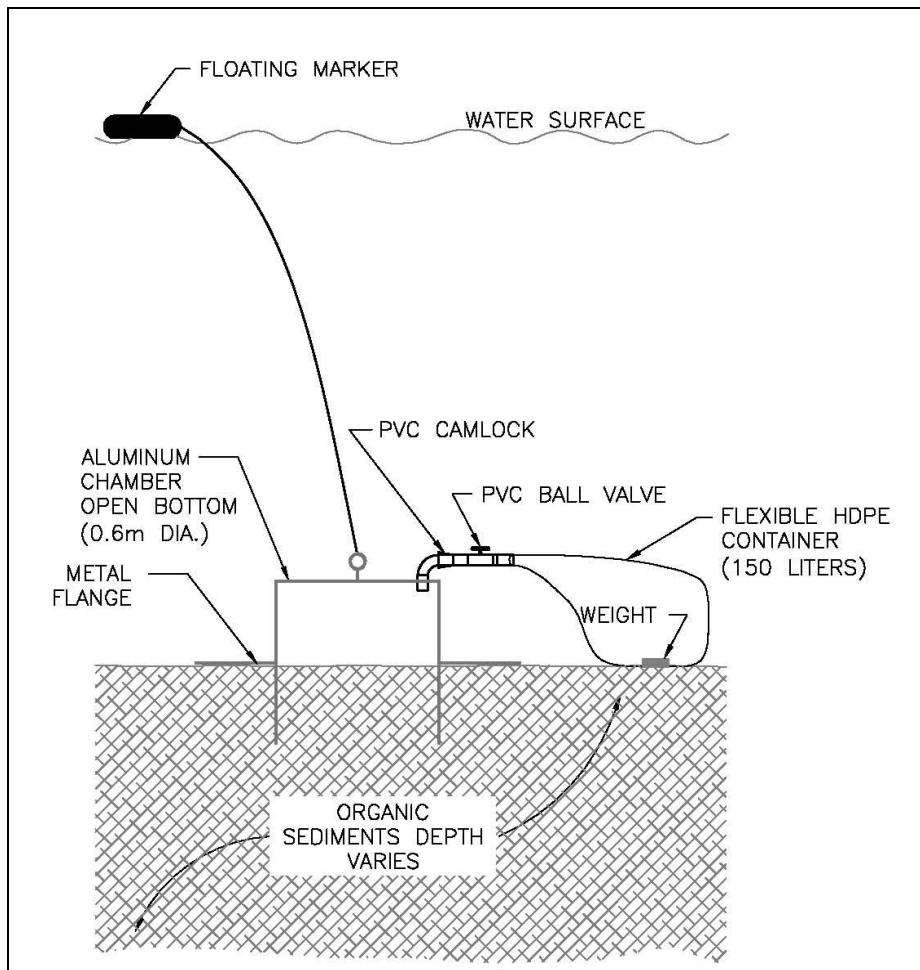

Figure 4-5.
Typical Seepage
Meter Installation.



Figure 4-6.
Seepage Meters Being
Prepared for Installation.

Seepage meters were inserted through the unconsolidated and consolidated sediment layers and into the parent bottom material by repeatedly pounding around the perimeter of the meter using a 20-pound hammer weight until the seepage meter met significant resistance from the sediment material, and no additional movement of the meter was observed. Seepage meters installed in these areas were extremely stable, and additional settling of the seepage meters during the monitoring program was very unlikely.

Each seepage meter was installed with a slight tilt toward the outlet point so that any gases which may be generated inside the seepage meter would exit into the collection container. Two 10-ounce plastic-coated fishing weights were placed inside each of the collection bags to prevent the bags from floating up towards the water surface as a result of trapped gases. The location of each seepage meter was indicated by a floating marker which was attached to the seepage meter using a coated wire cable.

Seepage meters were installed at 16 locations in Marco Island waterways on April 29 and May 5, 2020. Locations for the seepage meters are indicated on Figure 4-7. The seepage meter sites are superimposed over a map of the Marco Island reuse irrigation distribution area for reference purposes. Seepage meters were installed adjacent to the seawalls at a water depth of 4-6 ft, depending on location.

4.1.4.2 Seepage Meter Monitoring

Installation of Marco Island seepage meters was conducted on April 29 and May 5, 2020. Polyethylene collection bags (200 liter) were attached at the time of installation to each of the seepage meters. The initial seepage monitoring event was conducted on May 26-27, 2020, approximately 27-32 days following installation, depending on initial installation date. During this event, the volume of seepage collected at each site was measured and recorded, but the collected sample was discarded since the initial collected seepage sample represents a combination of seepage inflow and water trapped inside the seepage meter at the time of installation.

Beginning with the second monitoring event, samples were collected and retained for laboratory analyses. Each of the 16 seepage meters was monitored on approximately a monthly basis from May-November 2020, with 6 separate monitoring conducted for evaluation of seepage quantity at each of the monitoring sites. The seepage meters were removed at the end of the monitoring program in November 2020.

4.1.4.3 Seepage Inflow

A summary of field measurements of seepage inflows at the Marco Island monitoring sites from May-November 2020 is given in Appendix E-1. During collection of the seepage samples, information was recorded on the date and time of sample collection, the volume of seepage collected at each site, general observations regarding the condition of the seepage collection bags, and replacement/repair details. The seepage inflow rate at each location is calculated by dividing the total collected seepage volume (liters) by the area of the seepage meter (0.27 m^2) and the time (days) over which the seepage sample was collected.

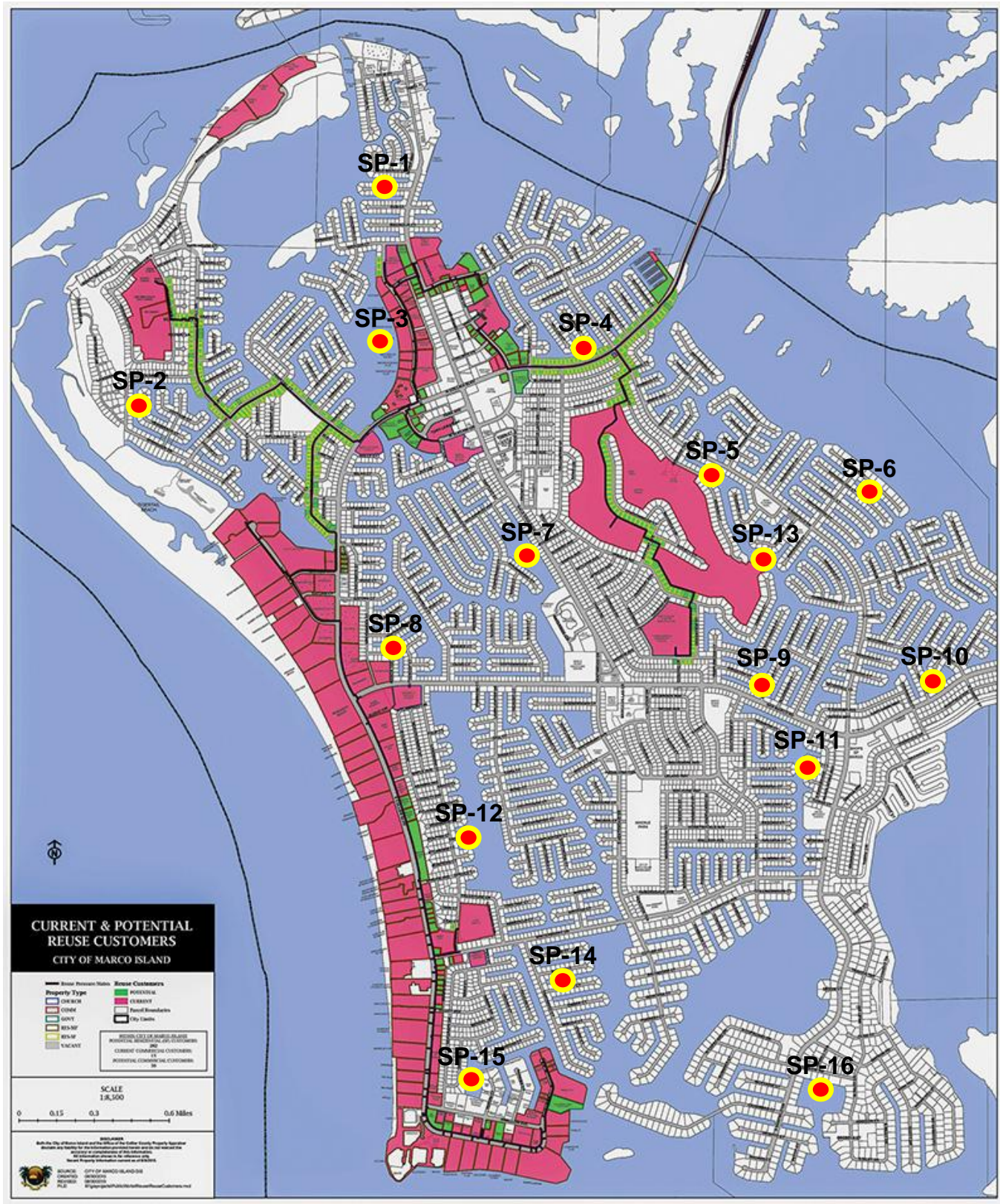

Figure 4-7. Locations of Marco Island Seepage Monitoring Sites.
(Base Map Source: City of Marco Island Reuse Customer Map)

As seen in Appendix E-1, several seepage meter sites contain missing data for one or more events during the field monitoring program as a result of a damaged collection bag or missing seepage meters. In these cases, the damaged bag was replaced with a new bag, but no seepage sample was obtained for the event. A total of 6 seepage field monitoring events was conducted at the 16 seepage meter sites, with a potential of 96 field measurements overall at the 16 seepage monitoring sites. During the field monitoring program, a total of 81 seepage samples was collected out of a possible 96 samples, for a 84% sample success rate which is slightly better than typical seepage sample collection success rates of 70-75% in studies conducted by ERD.

The seepage meter initially installed at Site 16 in the rectangular cove located between S. Barfield Dr. and Inlet Dr. was missing at the time of the first monitoring event. The meter was replaced at a different location, and this meter was also missing at the time of the second monitoring event. The meter was again replaced and moved to a new location, but this meter was missing at the time of the next monitoring event. After the third missing seepage meter, attempts to monitor seepage in this area were discontinued.

A summary of mean seepage inflow measurements collected at the 16 seepage meter monitoring sites is given in Table 4-9. Mean seepage values measured at the Marco Island monitoring sites ranged from 1.46-13.07 liters/m²-day, with a majority of measured values ranging from approximately 1-10 liters/m²-day. A similar degree of variability was observed in the measured minimum and maximum seepage influx rates during the field monitoring program.

For comparison purposes, mean seepage values are summarized by drainage sub-basin in Table 4-10. Measured seepage values in most sub-basins exhibit a high degree of variability in measured values as a result of variability in the transmissivity of rear yard soils adjacent to the seawalls. However, in spite of the individual variability between sites, the overall sub-basin mean values are remarkably similar, ranging from 6.11-8.14 liters/m²-day.

Since seepage inputs have a potential to introduce large loadings of nutrients to Marco Island waterways, and is likely a significant loading source, a hydrologic mass balance for seepage inflows was developed to corroborate the field measured values. The hydrologic balance estimates groundwater inputs which become seepage using the following equation:

$$\textit{Seepage} = (\textit{Rainfall} + \textit{Irrigation}) - (\textit{Runoff} + \textit{Evapotranspiration})$$

For this analysis, the annual rainfall volume is assumed to equal the sub-basin area (minus stormwater ponds) times the assumed annual average rainfall of 53.3 inches/year. Runoff volumes are based on the delivered runoff values summarized in Table 4-6. Irrigation volumes are based on the values summarized in Table 4-8. Evaporation from impervious areas is based on the methodology developed for FDEP by Harper and Baker (2007), and evapotranspiration from pervious surfaces is assumed to be 3.15 mm/day for St. Augustine grass (Source: IFAS).

TABLE 4-9

**FIELD MEASURED HYDROLOGIC INPUTS TO MARCO ISLAND WATERWAYS
FROM GROUNDWATER SEEPAGE FROM MAY-NOVEMBER 2020**

| SITE | NUMBER OF SAMPLES | MINIMUM VALUE (liters/m ² -day) | MAXIMUM VALUE (liters/m ² -day) | MEAN VALUE (liters/m ² -day) | BASIN |
|------|-------------------|---|---|--|-------|
| 1 | 5 | 0.48 | 17.72 | 4.64 | 1 |
| 2 | 6 | 0.68 | 4.62 | 2.40 | 1 |
| 3 | 6 | 0.68 | 2.66 | 1.46 | 1 |
| 4 | 5 | 2.26 | 14.72 | 8.14 | 2 |
| 5 | 5 | 0.31 | 14.00 | 4.14 | 3 |
| 6 | 5 | 7.68 | 17.75 | 13.07 | 3 |
| 7 | 4 | 11.57 | 14.69 | 12.57 | 1 |
| 8 | 6 | 4.03 | 17.75 | 9.47 | 1 |
| 9 | 5 | 0.77 | 15.65 | 6.08 | 3 |
| 10 | 5 | 0.68 | 14.72 | 4.63 | 3 |
| 11 | 6 | 0.69 | 14.48 | 7.07 | 5 |
| 12 | 6 | 4.23 | 14.48 | 8.86 | 4 |
| 13 | 5 | 1.60 | 17.75 | 9.76 | 3 |
| 14 | 6 | 0.45 | 9.31 | 3.99 | 4 |
| 15 | 6 | 1.02 | 13.07 | 5.66 | 4 |
| 16 | 0 | 0.00 | 0.00 | ----- | 5 |

TABLE 4-10

MEAN SEEPAGE VALUES BY SUB-BASIN

| BASIN | SITE | MEAN VALUE BY SUB-BASIN | BASIN MEAN |
|-------|------|----------------------------|---------------|
| 1 | 1 | 4.64 | 6.11 |
| | 2 | 2.40 | |
| | 3 | 1.46 | |
| | 7 | 12.57 | |
| | 8 | 9.47 | |
| 2 | 4 | 8.14 | 8.14 |
| 3 | 5 | 4.14 | 7.54 |
| | 6 | 13.07 | |
| | 9 | 6.08 | |
| | 10 | 4.63 | |
| | 13 | 9.76 | |
| 4 | 12 | 8.86 | 6.17 |
| | 14 | 3.99 | |
| | 15 | 5.66 | |
| 5 | 11 | 7.07 | 7.07 |
| | 16 | - | |

A summary of the hydrologic mass balance for seepage inflows is given on Table 4-11 for Sub-basins 1-5. The annual total seepage volume is calculated for each sub-basin based on the hydrologic budget equation and assumptions. The annual seepage volume is divided by the waterway area for each sub-basin, resulting in seepage influx values ranging from 6.6-10.7 liters/m²-day, indicating relatively close agreement between measured and calculated values, especially when the field measured values only reflect a portion of an annual cycle. For purposes of this project, the calculated annual seepage volumes listed in Table 4-11 for Sub-basins 1-5 are used for development of the hydrologic and nutrient budgets.

TABLE 4-11
HYDROLOGIC BALANCE FOR SEEPAGE
INFLOWS TO MARCO ISLAND WATERWAYS

| PARAMETER | | | | | | | | | | | |
|---------------|---------------------------|---------------------------------------|----------------------------|--------------------------|------------------------------|---------------------------------------|-------------------------------------|----------------------------|---------------------------|--------------------------|--|
| Sub-Basin | Sub-Basin Area (acres) | Delivered Runoff Volume (ac-ft) | Impervious Area (acres) | Pervious Area (acres) | Irrigation Volume (ac-ft) | ET from Impervious Area (ac-ft) | ET from Pervious Area (ac-ft) | Rainfall Volume (ac-ft) | Seepage Volume (ac-ft) | Waterway Area (acres) | Seepage Inflow (liters/m ² -day) |
| 1 | 1,469.43 | 429 | 674.31 | 795.11 | 1,919 | 530 | 2,999 | 6,527 | 4,487 | 565.51 | 6.6 |
| 2 | 306.16 | 94.4 | 173.95 | 132.22 | 301 | 137 | 499 | 1,360 | 931 | 75.65 | 10.3 |
| 3 | 895.53 | 148 | 386.09 | 509.45 | 1,327 | 304 | 1,922 | 3,978 | 2,932 | 227.87 | 10.7 |
| 4 | 942.36 | 208 | 493.52 | 448.85 | 1,122 | 388 | 1,693 | 4,186 | 3,020 | 374.28 | 6.7 |
| 5 | 814.62 | 133 | 365.29 | 449.33 | 974 | 287 | 1,695 | 3,618 | 2,477 | 281.65 | 7.3 |
| TOTAL: | 4,428.10 | 1,012 | 2,093.16 | 2,334.96 | 5,643 | 1,646 | 8,808 | 19,669 | 13,846 | 1,524.96 | -- |

4.2 Hydrologic Losses

Hydrologic losses from Marco Island waterways occur as a result of evaporation from the water surface and discharge of excess water to tide. Estimated losses from each of these sources are discussed in the following sections.

Although daily tidal cycles can remove and replace water in areas close to off-shore open water, significant water exchange is limited in canals located in upstream areas due to geometry, long travel paths, and hydraulic limitations. In these areas, the water volume within the canals simply moves back and forth with the tidal cycle and is not replaced with the exception of excess water discharges.

4.2.1 Evaporation Losses

Long-term reliable evaporation data are relatively rare in Florida, with only a limited number of sites available. Estimates of monthly evaporation from Marco Island waterways were generated based upon mean monthly pan evaporation data collected at the Tamiami Trail monitoring station over the 39-year period from 1941-1979. The Tamiami Trail station is located approximately 25 miles east of Marco Island and appears to be the closest long-term evaporation monitoring site in the Southwest Florida area. A summary of mean monthly evaporation for this site is given in Table 4-12.

TABLE 4-12

**MEAN MONTHLY LAKE EVAPORATION
AT THE TAMIAMI TRAIL STATION SITE**

| MONTH | MEAN PAN EVAPORATION (inches) | LAKE EVAPORATION ¹ (inches) | MONTH | MEAN PAN EVAPORATION (inches) | LAKE EVAPORATION ¹ (inches) |
|----------|-------------------------------|--|---------------|-------------------------------|--|
| January | 3.36 | 2.35 | July | 6.87 | 4.81 |
| February | 3.85 | 2.70 | August | 6.57 | 4.60 |
| March | 5.41 | 3.79 | September | 5.36 | 3.75 |
| April | 6.31 | 4.42 | October | 5.53 | 3.87 |
| May | 6.83 | 4.78 | November | 3.81 | 2.67 |
| June | 6.15 | 4.31 | December | 3.20 | 2.24 |
| | | | TOTAL: | 63.25 | 44.29 |

1. Assumed to be 70% of pan evaporation (Jones, 1992)

Pan evaporation rates are used to estimate water surface evaporation by multiplying the measured pan evaporation by a factor called the “pan coefficient”. The pan coefficient is a factor less than one which corrects for heat exchange through the sides and bottom of the pan which are not available to the water in a lake. The pan coefficient commonly used to compute free water surface evaporation from pan evaporation is 0.7 (Jones, 1992).

For purposes of this project, the mean evaporation measured at the Tamiami Trail site is assumed to be similar to evaporation at the Marco Island waterways. The recorded data at the Tamiami Trail site reflects pan evaporation, with lake evaporation assumed to be equal to 70% of the pan evaporation values.

A summary of estimated monthly evaporation losses from Marco Island waterways in Sub-basins 1-5 is given in Table 4-13. The values summarized in this table were obtained by multiplying the surface areas for waterways in each of the 5 sub-basins (Table 3-3) times the estimated monthly lake evaporation values (listed in Table 4-12). Mean annual volumetric losses from evaporation remove approximately 279.2-2,087.2 ac-ft/yr from the sub-basin areas.

TABLE 4-13

**MEAN MONTHLY AND ANNUAL EVAPORATION
LOSSES FROM MARCO ISLAND WATERWAYS**

| MONTH | MEAN EVAPORATION (inches) ¹ | MONTHLY PRECIPITATION INPUTS (ac-ft) | | | | |
|---------------|--|---|---------------------------|----------------------------|----------------------------|----------------------------|
| | | Sub-basin 1 (565.51 ac) | Sub-basin 2 (75.65 ac) | Sub-basin 3 (227.87 ac) | Sub-basin 4 (374.28 ac) | Sub-basin 5 (281.65 ac) |
| January | 2.35 | 110.7 | 14.8 | 44.6 | 73.3 | 55.2 |
| February | 2.70 | 127.2 | 17.0 | 51.3 | 84.2 | 63.4 |
| March | 3.79 | 178.6 | 23.9 | 72.0 | 118.2 | 89.0 |
| April | 4.42 | 208.3 | 27.9 | 83.9 | 137.9 | 103.7 |
| May | 4.78 | 225.3 | 30.1 | 90.8 | 149.1 | 112.2 |
| June | 4.31 | 203.1 | 27.2 | 81.8 | 134.4 | 101.2 |
| July | 4.81 | 226.7 | 30.3 | 91.3 | 150.0 | 112.9 |
| August | 4.60 | 216.8 | 29.0 | 87.4 | 143.5 | 108.0 |
| September | 3.75 | 176.7 | 23.6 | 71.2 | 117.0 | 88.0 |
| October | 3.87 | 182.4 | 24.4 | 73.5 | 120.7 | 90.8 |
| November | 2.67 | 125.8 | 16.8 | 50.7 | 83.3 | 62.7 |
| December | 2.24 | 105.6 | 14.1 | 42.5 | 69.9 | 52.6 |
| TOTAL: | 44.29 | 2,087.2 | 279.2 | 841.0 | 1,381.4 | 1,039.5 |

1. Mean monthly lake evaporation at the Tamiami Trail meteorological monitoring site from 1941-1979

4.2.2 System Discharges

Discharges from Marco Island waterways occur from the canals as a result of excess water in the hydrologic budget. For purposes of this analysis, mean annual discharges from the waterways are calculated as the difference between quantified inputs and outputs for each waterway on an annual basis according to the following relationship:

$$\text{Waterway Discharge} = (\text{Precipitation} + \text{Runoff Inputs} + \text{Seepage}) - (\text{Evaporation})$$

This information is calculated as part of the hydrologic budgets summarized in Section 4.3 and reflects discharges from each sub-basin waterway over a long-term annual average basis, and does not necessarily reflect or predict system discharges during any particular year.

4.3 Hydrologic Budget

A mean annual hydrologic budget was developed for each of the 5 sub-basin waterways based on the analyses provided in previous sections. A discussion of the annual hydrologic budgets is given in the following sections.

4.3.1 Hydrologic Inputs

A summary of calculated hydrologic inputs to Marco Island on an average annual basis under current conditions is given in Table 4-14. Estimates of hydrologic inputs are provided for direct precipitation, stormwater runoff, irrigation, and groundwater seepage.

TABLE 4-14
MEAN ANNUAL HYDROLOGIC INPUTS
TO MARCO ISLAND SUB-BASINS 1-5

| SOURCE | SUB-BASIN 1 | | SUB-BASIN 2 | | SUB-BASIN 3 | | SUB-BASIN 4 | | SUB-BASIN 5 | |
|----------------------|--------------------------|----------------------|--------------------------|----------------------|--------------------------|----------------------|--------------------------|----------------------|--------------------------|----------------------|
| | Annual Inflow (ac-ft/yr) | Percent of Total (%) | Annual Inflow (ac-ft/yr) | Percent of Total (%) | Annual Inflow (ac-ft/yr) | Percent of Total (%) | Annual Inflow (ac-ft/yr) | Percent of Total (%) | Annual Inflow (ac-ft/yr) | Percent of Total (%) |
| Precipitation | 2,512 | 33.8 | 336 | 24.7 | 1,012 | 24.7 | 1,662 | 34.0 | 1,251 | 32.4 |
| Runoff | 429 | 5.8 | 94.3 | 6.9 | 148 | 3.6 | 207 | 4.2 | 133 | 3.4 |
| Groundwater Seepage | 4,487 | 60.4 | 931 | 68.4 | 2,932 | 71.7 | 3,020 | 61.8 | 2,477 | 64.2 |
| TOTAL: | 7,428 | 100.0 | 1,361 | 100.0 | 4,092 | 100.0 | 4,889 | 100.0 | 3,861 | 100.0 |
| Depth Over Waterway: | 13.1 ft | | 17.8 ft | | 18.0 ft | | 13.1 ft | | 13.7 ft | |

The largest annual hydrologic input to the 5 waterways is groundwater seepage which contributes 60-72% of the total annual hydrologic inputs to the systems. Direct precipitation is the second most significant hydrologic input, contributing 25-34% of annual hydrologic inputs. Inputs of stormwater runoff are minimal in terms of the annual hydrologic budgets, contributing only 3-7% of the annual volumetric inflows. Graphical comparisons of annual hydrologic inputs to the Marco Island waterways are given in Figure 4-8.

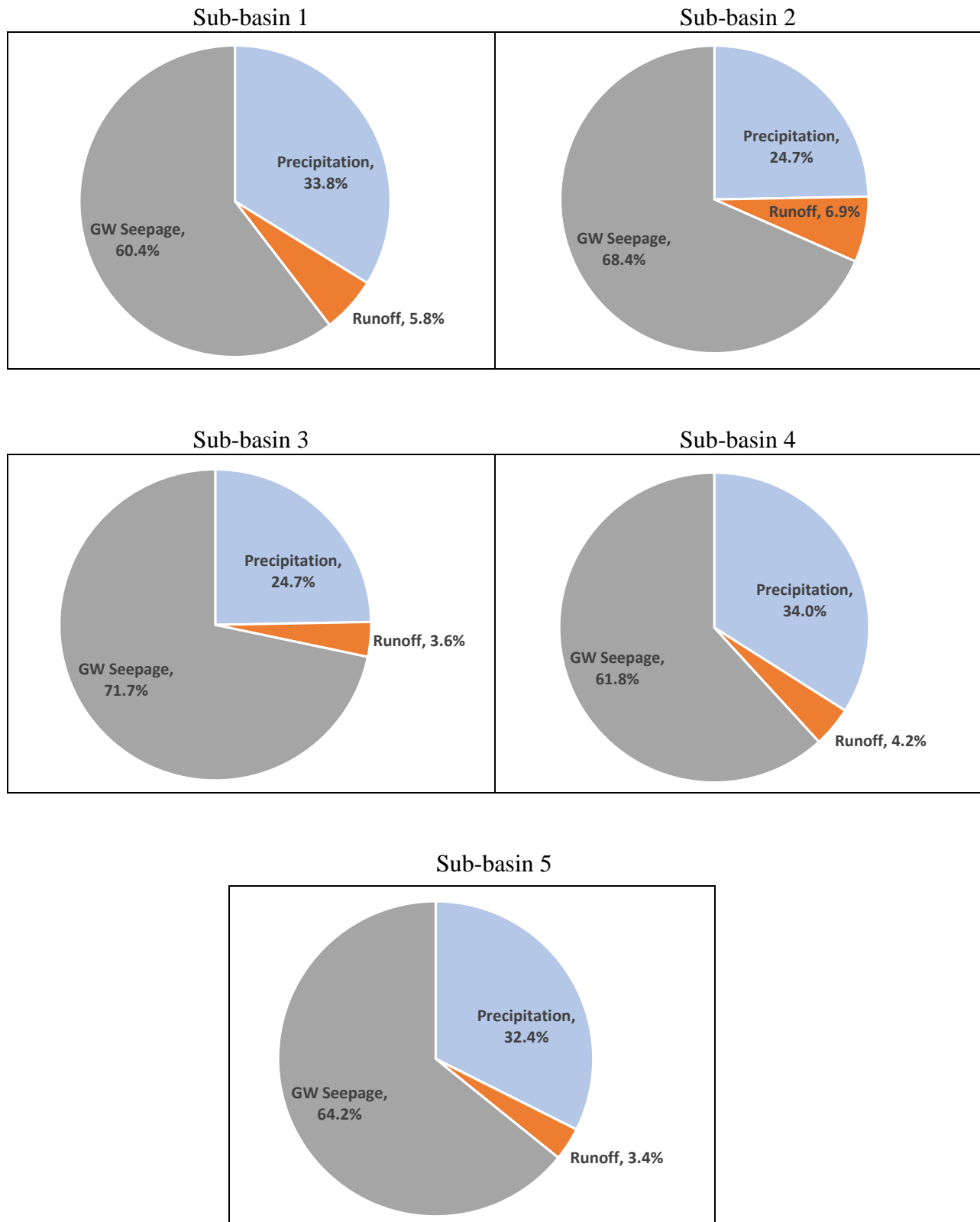

Figure 4-8. Graphical Comparisons of Annual Hydrologic Inputs to the Marco Island Waterways.

Annual volumetric inputs are also expressed as a depth over the waterway surface by dividing the surface area for each waterway by the annual volumetric inputs summarized in Table 4-14. This calculation provides a comparison of watershed inflows normalized for the surface area of the receiving waterbody. This calculation is provided in the final row of Table 4-14. The annual hydrologic inflows to the Marco Island waterways are equivalent to a depth of 13.1-18.0 ft over the waterway area, depending on the sub-basin. This inflow depth is extraordinarily high compared with annual volumetric inflows to lakes which typically range from 1-2 ft. This information can also be used to compare flushing rates in the waterways with higher depths (such as in Sub-basins 2 and 3), indicating a higher flushing frequency compared with lower hydraulic depths (such as Sub-basins 1, 4, and 5).

4.3.2 Hydrologic Losses

A summary of mean annual hydrologic losses from Marco Island waterways is given in Table 4-15. Approximately 78-85% of the annual hydrologic inputs are lost from discharge of excess water through the canals, with 16-23% of the annual hydrologic inputs lost through evaporation. On an annual average basis, the calculated annual outflows from the waterways to tide are equivalent to a water depth of 12.8-20.1 ft over the entire waterway surface area, depending on the sub-basin. Graphical comparisons of mean annual hydrologic inputs and losses for Marco Island waterways are given on Figure 4-9.

TABLE 4-15

**MEAN ANNUAL HYDROLOGIC LOSSES
FROM MARCO ISLAND SUB-BASINS 1-5**

| SOURCE | SUB-BASIN 1 | | SUB-BASIN 2 | | SUB-BASIN 3 | | SUB-BASIN 4 | | SUB-BASIN 5 | |
|----------------------|--------------------------|----------------------|--------------------------|----------------------|--------------------------|----------------------|--------------------------|----------------------|--------------------------|----------------------|
| | Annual Inflow (ac-ft/yr) | Percent of Total (%) | Annual Inflow (ac-ft/yr) | Percent of Total (%) | Annual Inflow (ac-ft/yr) | Percent of Total (%) | Annual Inflow (ac-ft/yr) | Percent of Total (%) | Annual Inflow (ac-ft/yr) | Percent of Total (%) |
| Evaporation | 2,087 | 28.1 | 279 | 20.5 | 841 | 20.6 | 1,381 | 28.2 | 1,040 | 26.9 |
| Outflow | 5,341 | 71.9 | 1,082 | 79.5 | 3,251 | 79.4 | 3,508 | 71.8 | 2,821 | 73.1 |
| TOTAL: | 7,428 | 100.0 | 1,361 | 100.0 | 4,092 | 100.0 | 4,889 | 100.0 | 3,861 | 100.0 |
| Depth Over Waterway: | 9.4 ft | | 14.1 ft | | 14.3 ft | | 9.4 ft | | 10.0 ft | |

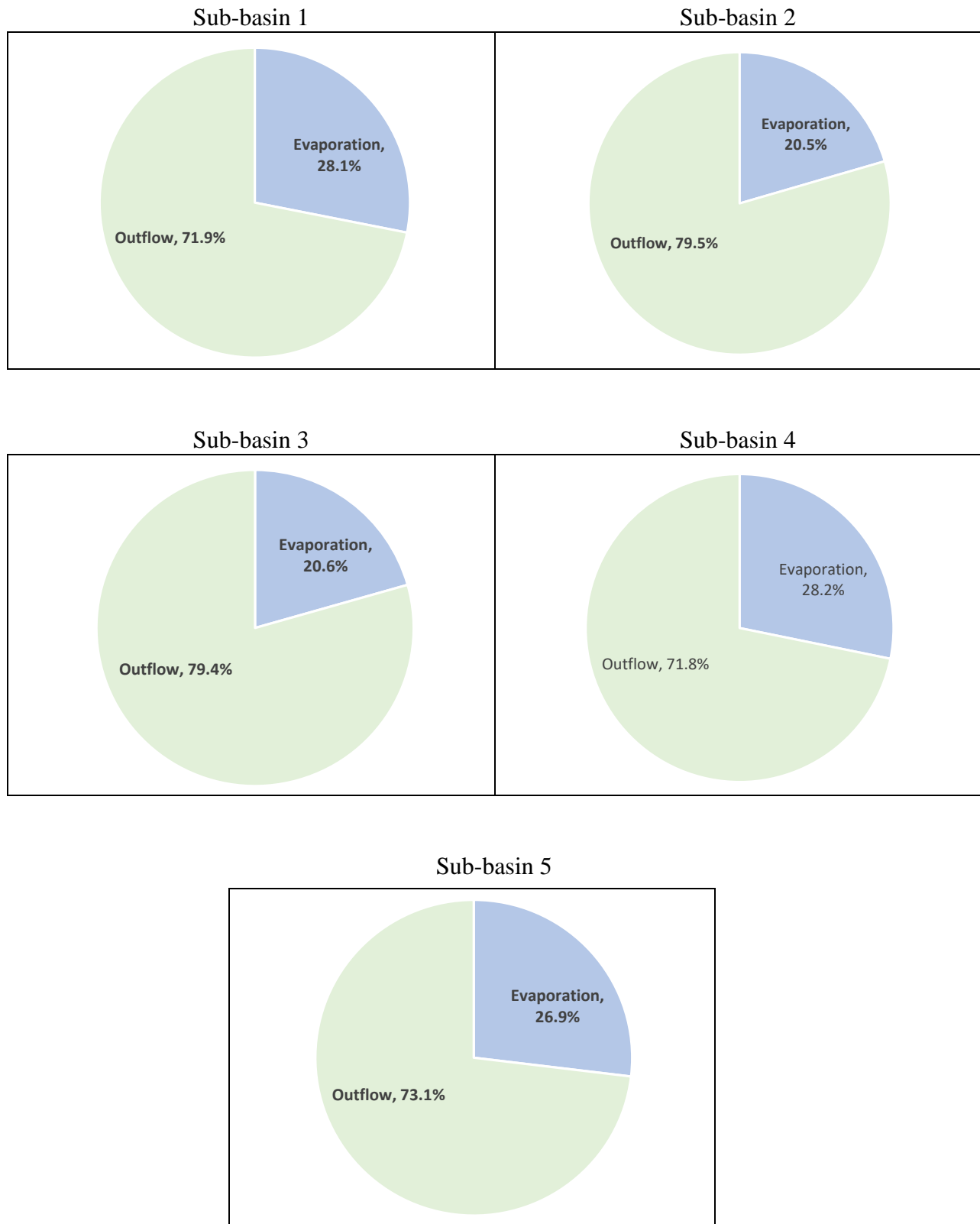

Figure 4-9. Graphical Comparisons of Annual Hydrologic Losses from the Marco Island Waterways.

4.4 Water Residence Time

For purposes of this analysis, water residence time for a waterbody is defined as the waterbody volume divided by the sum of the annual hydrologic inputs. Mean annual water residence times were calculated for each of the 5 sub-basins by dividing the estimated waterbody volume by the calculated mean annual hydrologic inputs for each sub-basin. However, accurate volumetric data do not appear to be available, so calculations were conducted based on assumed mean depths of 8, 10, and 12 ft for each waterway.

A summary of calculated mean annual residence time in Marco Island waterways is given in Table 4-16 for mean waterway depths of 8, 10, and 12 ft. Annual residence times as the assumed mean depth increases. The shortest annual residence times occur in Sub-basins 2 and 3, with the longest times in Sub-basins 1 and 4. Residence times range from 5-11 months, depending on sub-basin and assumed water depth.

TABLE 4-16

**MEAN ANNUAL RESIDENCE TIMES
IN MARCO ISLAND WATERWAYS**

| SUB-BASIN | WATERWAY AREA (acres) | ANNUAL HYDROLOGIC INFLOW (ac-ft/yr) | MEAN ANNUAL WATER RESIDENCE TIME FOR VARIOUS MEAN DEPTHS (days) | | |
|---------------|-----------------------------|--|---|---------------------------|---------------------------|
| | | | D _{mean} = 8 ft | D _{mean} = 10 ft | D _{mean} = 12 ft |
| 1 | 565.51 | 7,428 | 222 | 278 | 333 |
| 2 | 75.65 | 1,361 | 162 | 203 | 243 |
| 3 | 227.87 | 4,092 | 163 | 203 | 244 |
| 4 | 374.28 | 4,889 | 224 | 279 | 335 |
| 5 | 281.65 | 3,861 | 213 | 266 | 320 |
| TOTAL: | 1,524.96 | 21,631 | | | |

SECTION 5

NUTRIENT INPUTS AND LOSSES

Marco Island waterways receive nutrient inputs from a variety of sources which include bulk precipitation, stormwater runoff, irrigation, shallow groundwater seepage, and internal recycling. Chemical characteristics of bulk precipitation, stormwater runoff, reuse irrigation, and groundwater seepage, along with inputs from internal recycling, were measured by ERD during the period from April-November 2020. A discussion of these inputs, along with calculated mass loadings, is given in the following sections. Information from each of these sources is used to generate annual average nutrient budgets for total nitrogen and total phosphorus for the waterbodies in the 5 sub-basin areas. A conceptual schematic of evaluated nutrient sources and sinks in Marco Island waterways is given in Figure 5-1.

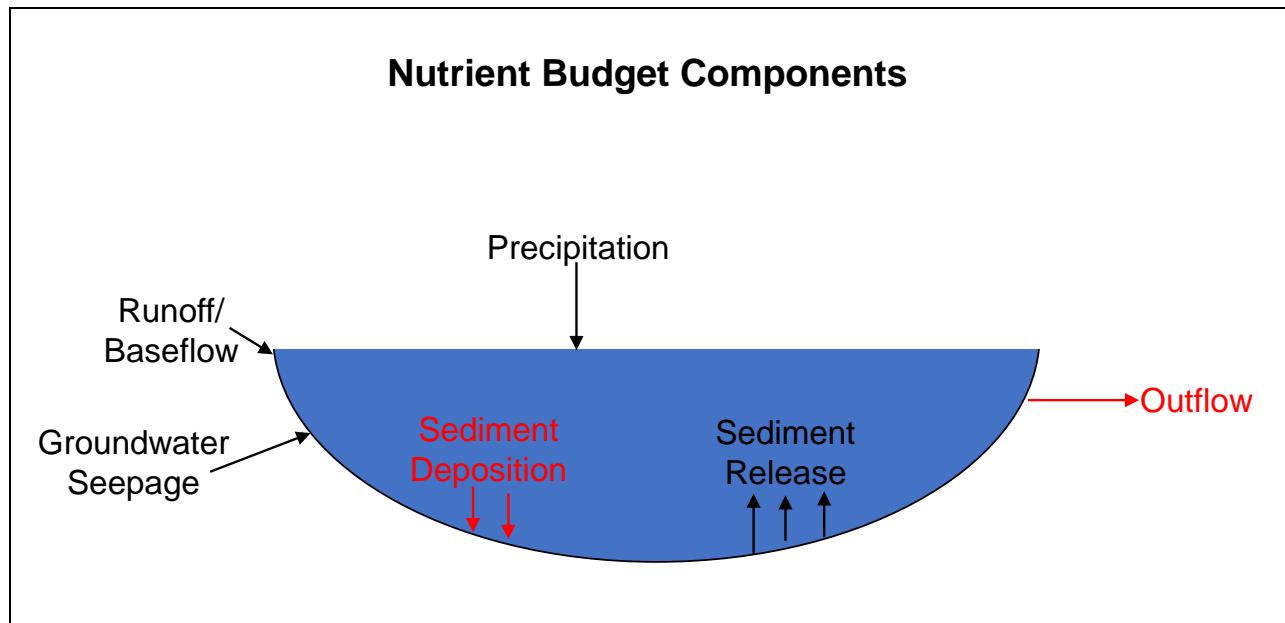

Figure 5-1. Conceptual Schematic of Evaluated Nutrient Inputs and Losses for Marco Island Waterways.

Irrigation is included as a hydrologic input on Figure 4-1, and estimates of annual volumetric inputs are developed in Section 4.1.3 to assist in calculating inputs to area waterways from groundwater seepage. However, irrigation is not included as a separate nutrient impact since the water quality impacts from irrigation are included in the measured characteristics for stormwater runoff and groundwater seepage.

5.1 Characteristics of Nutrient Inputs

5.1.1 Bulk Precipitation

Weekly composite samples of bulk precipitation were collected at the Public Works Yard site during the field monitoring program from May-November 2020. This site was also used to measure rainfall during the field monitoring program, as discussed in Section 4.1.1 and illustrated on Figure 4-2. Bulk precipitation samples at this site were collected as a composite of both wet and dry fallout which occurred between weekly field monitoring events. A total of 17 composite bulk precipitation samples was collected during the field monitoring program. A complete listing of laboratory analyses conducted on bulk precipitation samples is given in Appendix F-1.

5.1.1.1 Chemical Characteristics

Summary statistics for bulk precipitation samples collected at the Marco Island monitoring site from May-November 2020 are given in Table 5-1. Bulk precipitation samples were generally low in pH and poorly buffered, with low levels of conductivity. Bulk precipitation samples were also characterized by low levels of turbidity, color, and TSS, although slightly more elevated values were observed for each measured parameter on at least one occasion.

A statistical comparison of measured values for pH, conductivity, alkalinity, color, turbidity, and TSS for Marco Island bulk precipitation samples is given on Figure 5-2. Measured values for most parameters exhibited a relatively narrow range of values, although both high and low outlier values were observed for virtually all parameters. The measured values for pH, conductivity, and alkalinity in the bulk precipitation samples are higher than values observed by ERD in inland locations and may be related to impacts from ocean mist which is alkaline and well buffered.

Bulk precipitation samples contained moderate to low concentrations of nitrogen species, with the majority of nitrogen contributed by NO_x and dissolved organic nitrogen. Overall, the geometric mean total nitrogen concentration in bulk precipitation was 273 $\mu\text{g/l}$, reflecting a low value, although a wide range of values was measured in individual samples.

A statistical comparison of measured concentrations of nitrogen species in bulk precipitation is given on Figure 5-3. Concentrations for ammonia, NO_x , and dissolved organic nitrogen exhibited a wide range of values, although the overall geometric mean concentrations were very low in value.

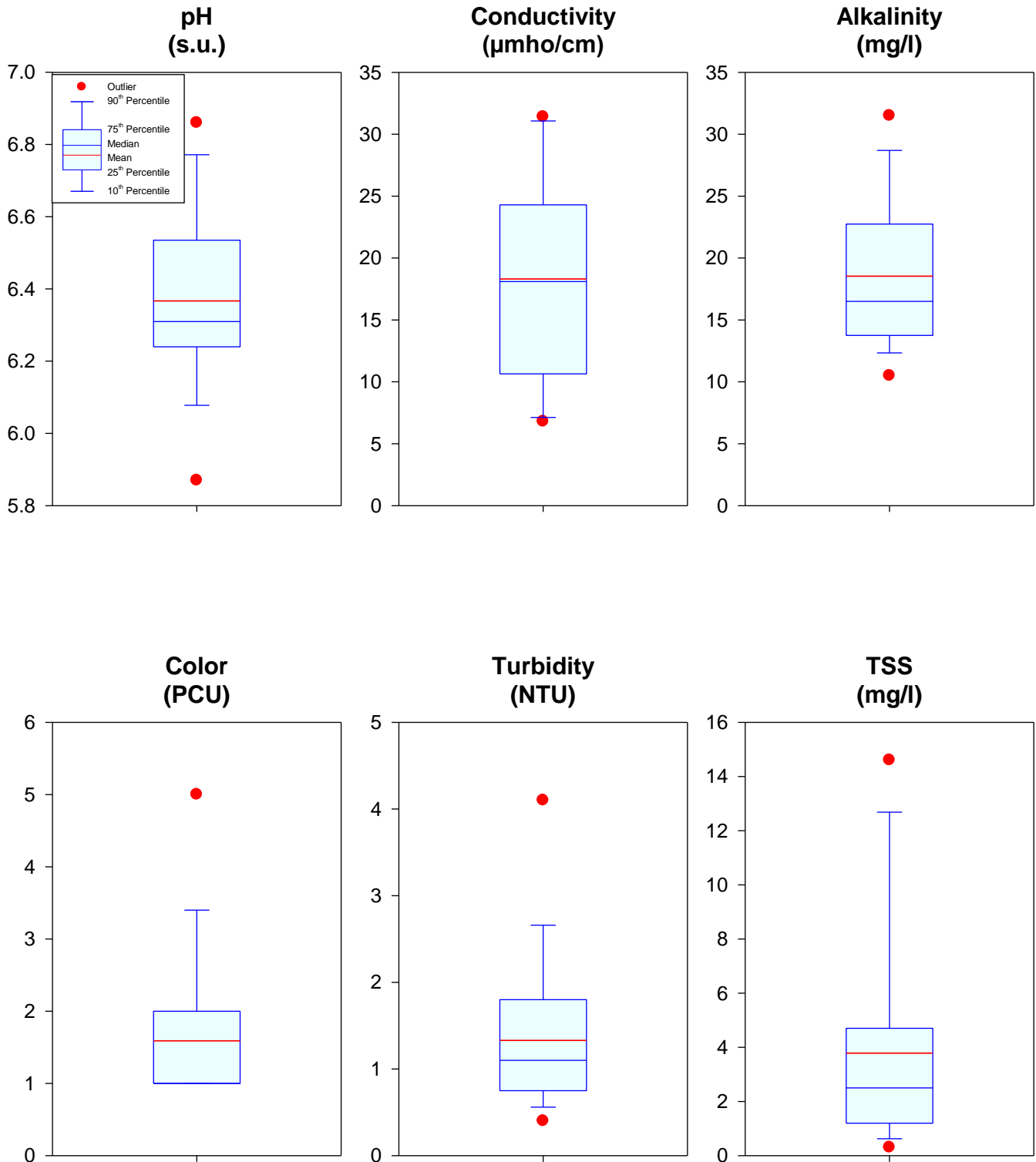

Figure 5-2. Statistical Comparison of Measured Values for pH, Conductivity, Alkalinity, Color, Turbidity, and TSS in Bulk Precipitation Samples Collected at Marco Island from May-November 2020.

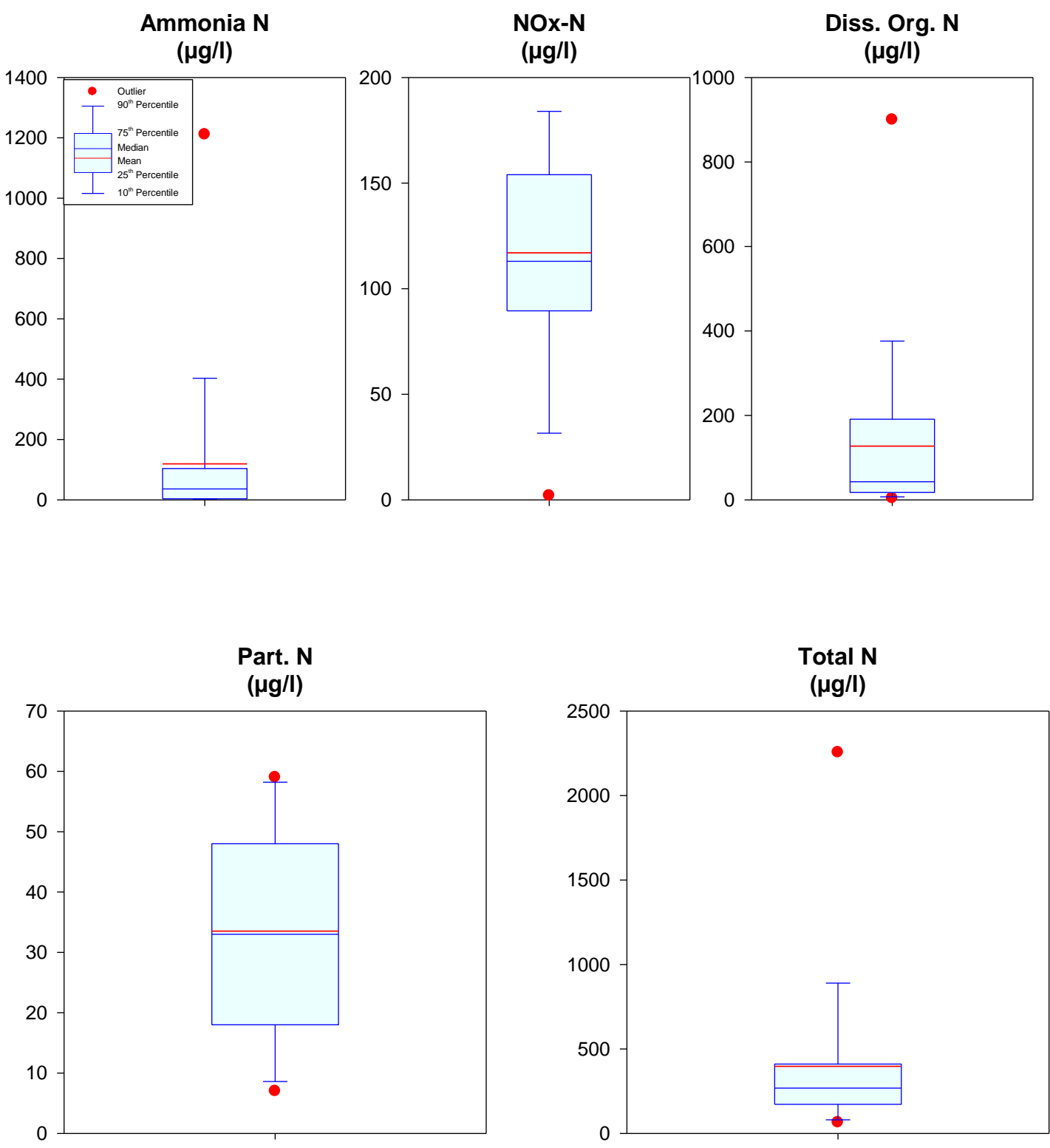

Figure 5-3. Statistical Comparison of Measured Values for Nitrogen Species in Bulk Precipitation Samples Collected at Marco Island from May-November 2020.

TABLE 5-1**SUMMARY STATISTICS FOR BULK PRECIPITATION SAMPLES
COLLECTED AT MARCO ISLAND FROM MAY-NOVEMBER 2020**

| PARAMETER | UNITS | MINIMUM VALUE | MAXIMUM VALUE | GEOMEAN |
|---------------------|---------|------------------|------------------|---------|
| pH | s.u. | 5.87 | 6.86 | 6.36 |
| Alkalinity | mg/l | 10.5 | 31.5 | 17.7 |
| Conductivity | µmho/cm | 7 | 31 | 16 |
| Ammonia | µg/l | 3 | 1,211 | 26 |
| NO _x -N | µg/l | 2 | 184 | 92 |
| Dissolved Organic N | µg/l | 4 | 900 | 127 |
| Particulate N | µg/l | 7 | 59 | 28 |
| Total N | µg/l | 65 | 2,255 | 273 |
| SRP | µg/l | 1 | 205 | 4 |
| Dissolved Organic P | µg/l | 6 | 88 | 30 |
| Particulate P | µg/l | 2 | 88 | 9 |
| Total P | µg/l | 11 | 354 | 43 |
| Turbidity | NTU | 0.4 | 4.1 | 1.1 |
| Color | Pt-Co | 1 | 5 | 1 |
| TSS | mg/l | 0.3 | 14.6 | 2.4 |
| Number of Samples: | | 17 | | |

Relatively low concentrations were observed for phosphorus species, although more elevated values were observed for both SRP and total phosphorus on at least one occasion. The most significant phosphorus species in bulk precipitation was dissolved organic phosphorus, with small contributions from SRP and particulate phosphorus. The overall geometric mean total phosphorus concentration of 43 µg/l is similar to bulk precipitation characteristics in inland areas.

A statistical comparison of measured concentrations of phosphorus species in bulk precipitation is given in Figure 5-4. Similar to nitrogen, phosphorus concentrations were highly variable between events, although overall geometric mean values are low.

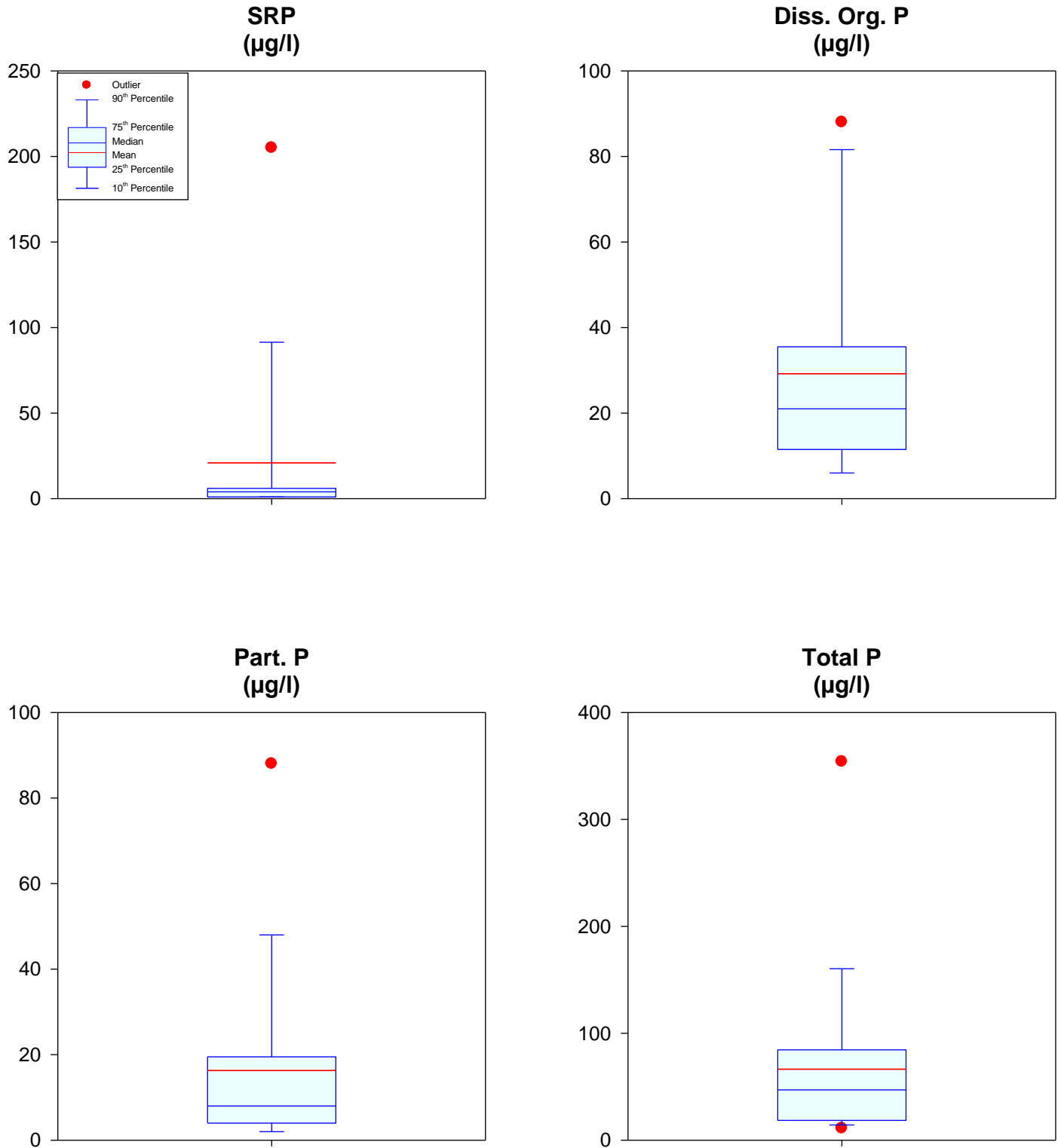

Figure 5-4. Statistical Comparison of Measured Values for Phosphorus Species in Bulk Precipitation Samples Collected at Marco Island from May-November 2020.

5.1.1.2 Mass Loadings

Estimates of annual mass loadings from bulk precipitation to the Marco Island waterways were calculated for total nitrogen and total phosphorus based upon the measured chemical characteristics for bulk precipitation listed in Table 5-1, and the estimated annual volumetric inputs from direct precipitation listed on Table 4-4. A summary of estimated loadings to Marco Island waterways from bulk precipitation is given in Table 5-2. On an average annual basis, bulk precipitation contributes approximately 2,278 kg/yr of total nitrogen and 358 kg/yr of total phosphorus to the Marco Island waterways.

TABLE 5-2

ANNUAL NUTRIENT LOADINGS TO MARCO ISLAND WATERWAYS FROM BULK PRECIPITATION

| SUB-BASIN | WATERWAY AREA (acres) | ANNUAL LOAD (kg/yr) | |
|---------------|-----------------------|---------------------|------------------|
| | | Total Nitrogen | Total Phosphorus |
| 1 | 565.51 | 845 | 133 |
| 2 | 76.65 | 113 | 17.7 |
| 3 | 227.87 | 340 | 53.4 |
| 4 | 374.28 | 559 | 87.8 |
| 5 | 281.65 | 421 | 66.1 |
| TOTAL: | 1,525.96 | 2,278 | 358 |

5.1.2 Stormwater Loadings

Estimates of runoff generated mass loadings of total nitrogen and total phosphorus entering Marco Island waterways were calculated using the hydrologic analyses discussed in Section 4 and the results of the field runoff monitoring program. A discussion of these analyses is provided in the following sections.

5.1.2.1 Monitoring Sites

Locations of stormwater monitoring sites used by ERD to characterize stormwater runoff within Marco Island are given on Figure 5-5. Five separate monitoring sites were selected which included commercial, residential, and industrial land uses in areas with and without reuse irrigation. Drainage basin areas discharging to each of the 5 monitoring sites are also illustrated on Figure 5-5.



Figure 5-5. Locations of Stormwater Monitoring Sites.

A summary of Marco Island stormwater monitoring sites is given on Table 5-3. Information is provided for the monitoring site location, description of associated dominant land use, and whether or not reuse irrigation is applied within the basin area for the stormwater monitoring site. A discussion of each of the 5 monitoring sites is given in the following sections.

TABLE 5-3

SUMMARY OF MARCO ISLAND STORMWATER MONITORING SITES

| MONITORING SITE | LOCATION | DESCRIPTION | REUSE IRRIGATION | ASSOCIATED SUB-BASIN AREA |
|-----------------|--|---------------------------------------|------------------|---------------------------|
| MI-1 | 6 th Avenue and Yellowbird Street | Residential area with low maintenance | No | 3 |
| MI-2 | W. Flamingo Circle and Maple Court | Commercial corridor | Yes | 4 |
| MI-3 | Bald Eagle Drive and Hartley Avenue | Commercial area | Partial | 1 |
| MI-4 | S. Barfield Drive and Watson Road | Residential with high maintenance | No | 5 |
| MI-5 | E. Elkcarn Circle and N. Barfield Drive | Industrial area | Yes | 2 |

5.1.2.1.1 Site MI-1

An overview of the drainage basin areas for monitoring sites MI-1 and MI-3 is given on Figure 5-6. Drainage basins for these monitoring sites are included on the same figure due to the close proximity of the 2 drainage basin areas. Monitoring site MI-1 is located at the intersection of Yellowbird Street and 6th Avenue and monitors runoff from a 47.52-acre area of residential homes with low maintenance activities. Reuse irrigation is not available within this drainage basin area. Runoff generated in this area is collected in a series of vegetated roadside swales. Periodic stormwater inlets divert the swale flow into an underground stormsewer system which ultimately discharges northward to the canal system north of Collier Blvd.

A photograph of stormwater monitoring site MI-1 is given on Figure 5-7. An insulated equipment shelter was installed on top of a stormsewer grate and housed an ISCO Model 6712 sequential autosampler with integral area-velocity flow probe. The autosampler was powered using a deep-cycle battery which was recharged with a solar panel attached to the roof of the equipment shelter. Sample collection tubing and flow meter cables were extended into the underground stormsewer system through an opening in the top of the grate inlet. The flow sensor was used to detect runoff discharging through the system and instructed the autosampler to collect composite flow-weighted samples during each discharge event.

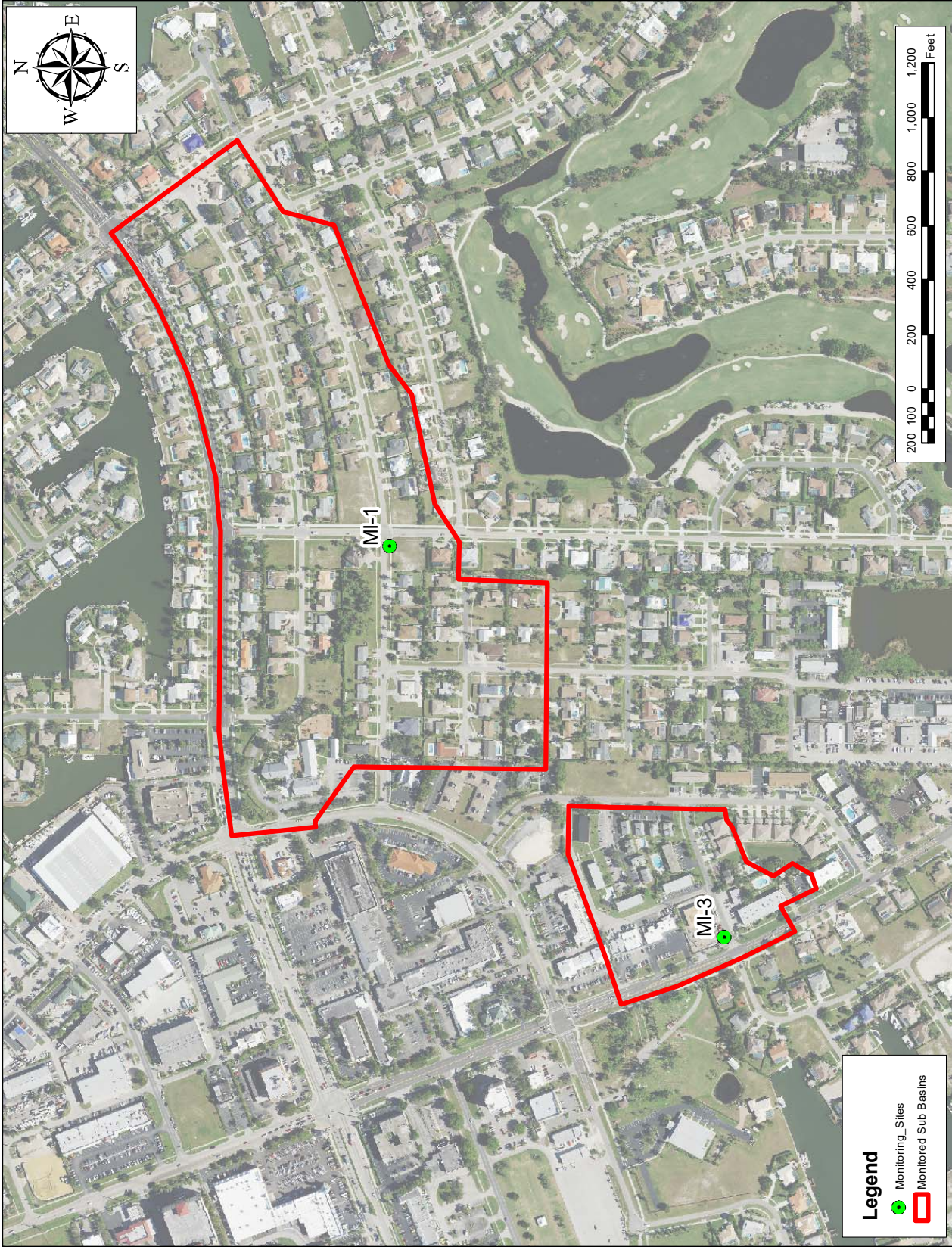

Figure 5-6. Overview of the Drainage Basin Areas for Monitoring Sites MI-1 and MI-3.

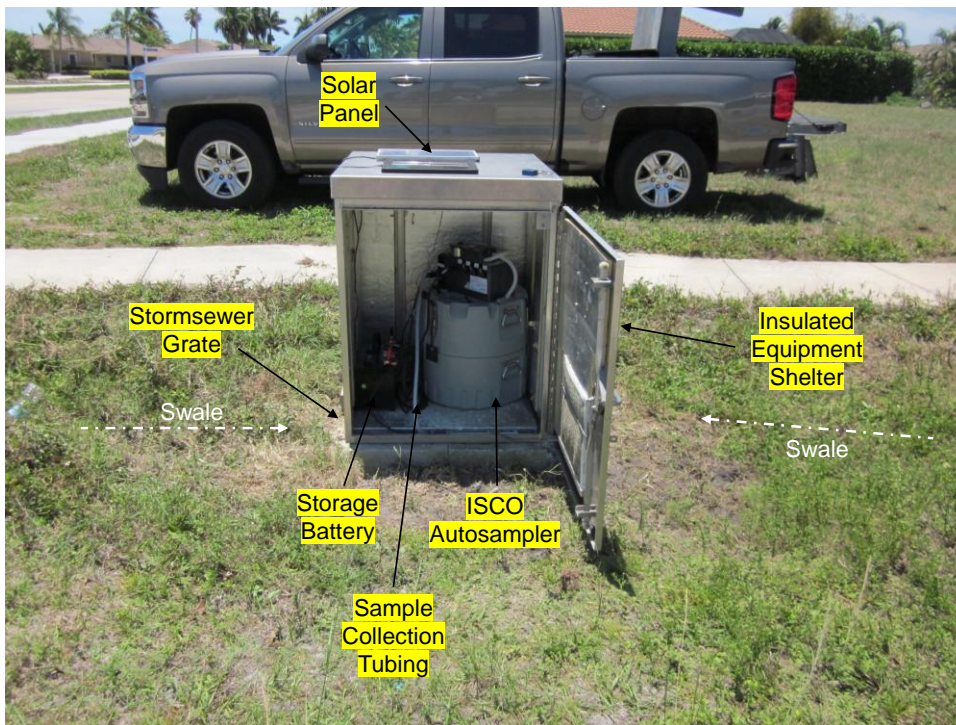

Figure 5-7.

Photograph of Stormwater Monitoring Site MI-1.

(Residential watershed with low maintenance and no reuse)

Discharge measurements at Site MI-1, as well as the other runoff monitoring sites, were conducted using an ISCO Model 750 area-velocity (AV) flow probe which provided simultaneous measurements of water depth and velocity in the 24-inch underground RCP. The measured water depth was converted into a cross-sectional area based upon the geometry of the 24-inch RCP and the depth of water. Discharge was then calculated in the flow module using the Continuity Equation:

$$Q = V \times A$$

where:

| | | |
|---|---|--|
| Q | = | discharge (ft ³ /sec or cfs) |
| A | = | cross-sectional area of the water in the pipe (ft ²) |
| V | = | flow velocity (ft/sec or fps) |

The internal flow meter for the autosampler provided a continuous measurement of discharge through the inflow culvert, with measurements stored in internal memory at 15-minute intervals, as well as providing input for collection of flow-weighted samples of the inflow over a wide range of flow conditions. The autosampler used at this site contained a single 20-liter polyethylene bottle with 250 ml aliquots of inflow pumped into the bottle at pre-set intervals of discharge, producing a composite flow-weighted sample of the inflow over a weekly period. The 24-inch piping inside the manhole structure at Site MI-1 was partially submerged throughout the field monitoring program.

5.1.2.1.2 Site MI-2

An overview of the drainage basin area for monitoring site MI-2 is given on Figure 5-8. The drainage basin area for site MI-2 includes 28.75 acres of highway, commercial, multi-family, and residential land uses, with areas adjacent to the Collier Blvd. corridor receiving reuse irrigation. The monitoring site is located on a main stormsewer line which collects runoff along Collier Blvd. and directs it east into the adjacent waterway system. Although residential areas can also discharge into this stormsewer system, runoff inputs from residential parcels appear to be relatively rare due to rapid infiltration in the roadside swale system, and the vast majority of runoff monitored at this site is generated from properties adjacent to the Collier Blvd. corridor.

A photograph of stormwater monitoring site MI-2 is given on Figure 5-9. An insulated equipment shelter was installed on top of a grate inlet, approximately 1 block east of Collier Blvd., which is connected to the 48-inch RCP trunk line that receives runoff from Collier Blvd. Sample collection tubing flow meter sensor cables were extended from the autosampler into the 48-inch RCP. The area-velocity stormwater flow sensor measured discharge during storm events and instructed the autosampler to collect flow-weighted composite samples during runoff events. The system was operated off a 12 VDC battery which was recharged using a roof-top-mounted solar panel.

5.1.2.1.3 Site MI-3

An overview of the drainage basin area for runoff monitoring site MI-3 was given on Figure 5-6. The drainage basin discharging to monitoring site MI-3 consists of 9.78 acres of commercial and multi-family residential land use located at the corner of Bald Eagle Drive and Hartley Avenue. Reuse irrigation is available in portions of the drainage basin adjacent to Bald Eagle Drive.

A photograph of stormwater monitoring site MI-3 is given on Figure 5-10. An insulated equipment shelter was installed on top of a stormsewer grate which is connected to the primary drainage system beneath Bald Eagle Drive. Drainage in this area is collected initially in a series of roadside swales before discharging into a 24-inch RCP underground stormsewer system. An ISCO Model 6712 sequential autosampler was placed inside the insulated equipment shelter with sample collection tubing and flow meter cables extending into the stormsewer system. Flow-weighted composite samples of runoff were collected during both storm and baseflow conditions during the field monitoring program.

5.1.2.1.4 Site MI-4

An overview of the drainage basin area for monitoring site MI-4 is given on Figure 5-11. This monitoring site receives runoff from a 6.04-acre drainage basin consisting of large residential homes with a high level of lawn care and maintenance activities. Runoff generated in this area is initially collected in a grassed roadside swale system with periodic inlet structures which collect the runoff from the swale and discharge it to an 18-inch underground stormsewer. Reuse irrigation is not available at this site, although the City applies reuse to median landscaping.

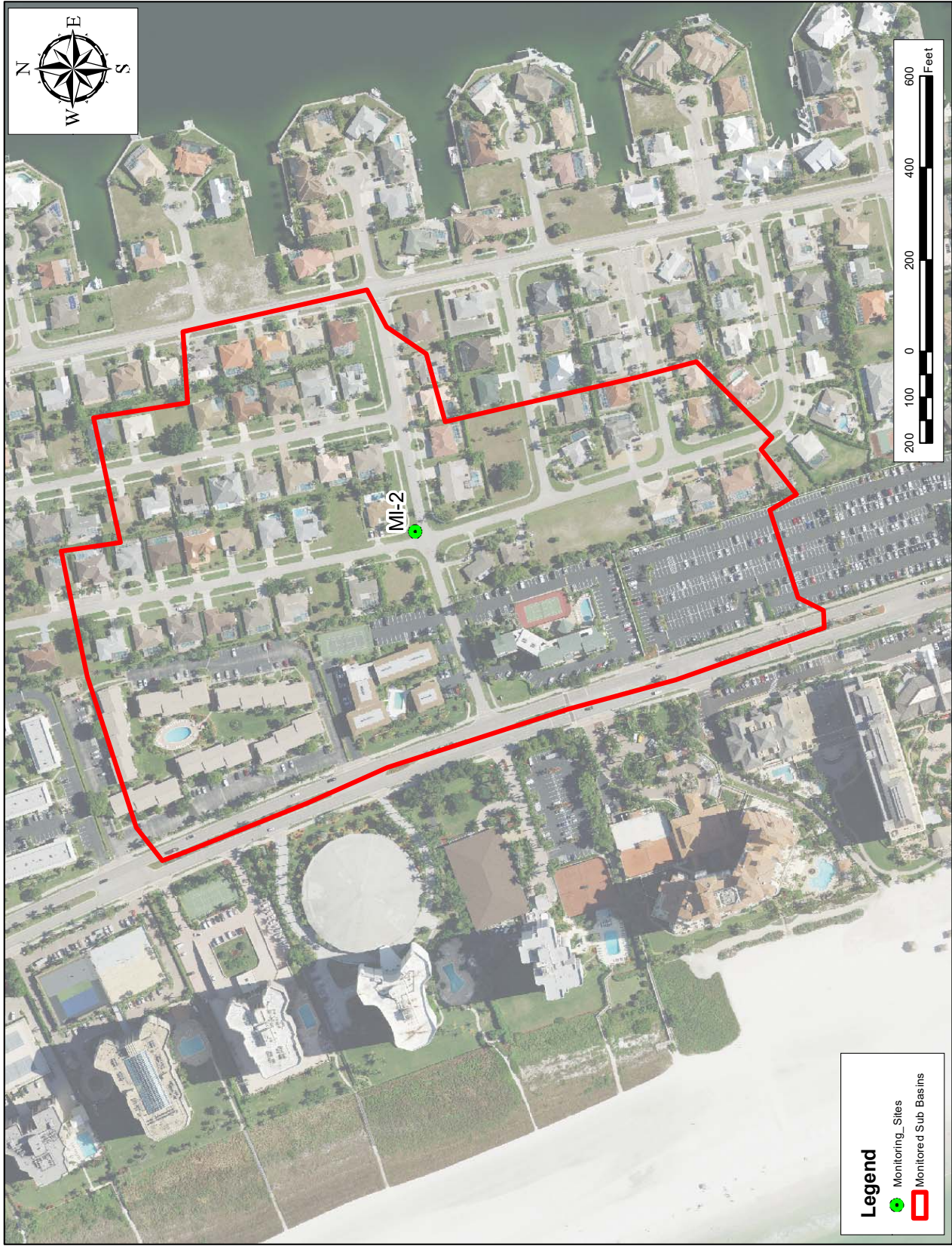

Figure 5-8. Overview of the Drainage Basin Area for Monitoring Site MI-2.

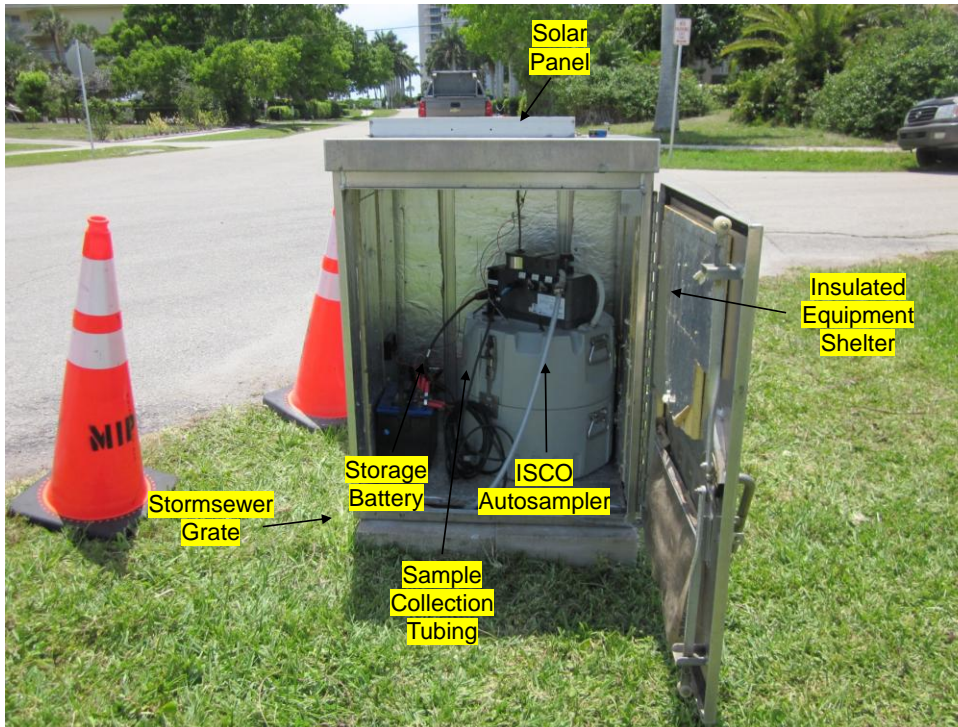

Figure 5-9.

Photograph of Stormwater Monitoring Site MI-2.

(Commercial watershed with reuse irrigation)



Figure 5-10.

Photograph of Stormwater Monitoring Site MI-3.

(Commercial watershed with partial reuse irrigation)



Figure 5-11. Overview of the Drainage Basin Area for Monitoring Site MI-4.

A photograph of stormwater monitoring equipment installed at site MI-4 is given on Figure 5-12. The installation is identical to equipment installed at the previously discussed sites. An insulated equipment shelter was installed on top of a stormwater inlet grate located in the roadside swale system. An ISCO Model 6712 autosampler was installed inside the insulated equipment shelter, with sample collection tubing and flow meter cables extended into the manhole structure. The area-velocity flow meter instructed the autosampler to collect the samples in a flow-weighted mode during monitoring rain events.



Figure 5-12.

Photograph of Stormwater Monitoring Site MI-4.

(Residential watershed with high maintenance)

5.1.2.1.5 Site MI-5

An overview of the drainage basin area for monitoring site MI-5 is given on Figure 5-13. This drainage basin consists of 3.09 acres of primarily commercial and industrial land use activities with a large amount of impervious surface. Reuse irrigation is available in this area.

A photograph of stormwater monitoring site MI-5 is given on Figure 5-14. An insulated aluminum equipment shelter was mounted on top of a grate inlet connected to the primary stormsewer system consisting of a 48-inch RCP which discharges from this area to Factory Bay. The stormwater monitoring equipment at this site was identical to the equipment used at the previous sites, consisting of an ISCO Model 6712 sequential autosampler which was programmed to collect flow-weighted composite samples during storm events.

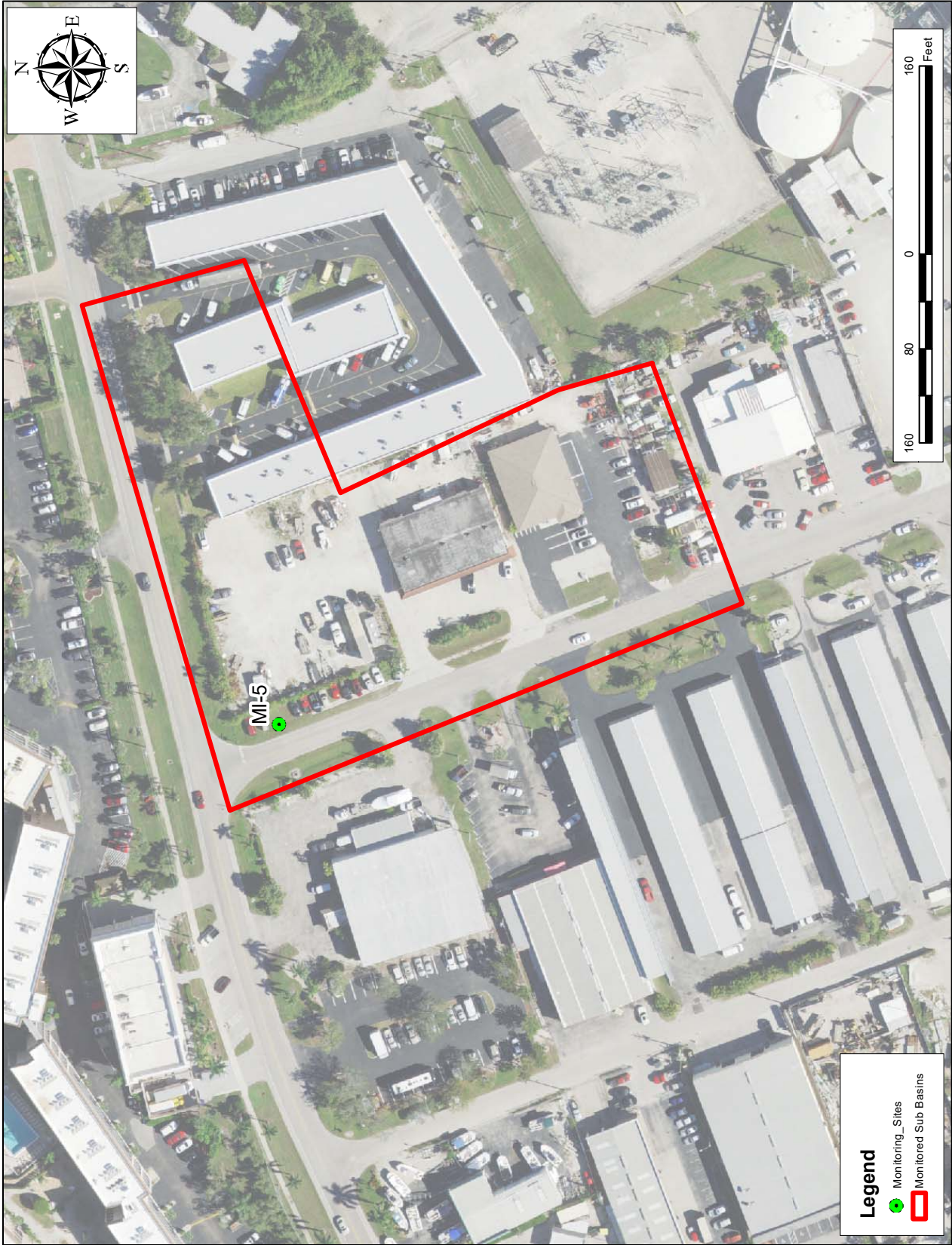

Figure 5-13. Overview of the Drainage Basin Area for Monitoring Site MI-5.



Figure 5-14.

Photograph of Stormwater
Monitoring Site MI-5.

(Industrial watershed with
partial reuse irrigation)

5.1.2.1.6 Reuse Monitoring Site

In addition to stormwater samples, ERD also collected weekly samples of reuse water generated by the Marco Island Reclaimed Water Production Facility. A photograph of the reuse monitoring site is given on Figure 5-15. The reuse monitoring site is located east of runoff monitoring site MI-5, and this site is used to estimate the characteristics of reuse irrigation used within the island. Samples were obtained by opening the indicated valve and, after a flushing period of approximately 30 seconds, a sample was collected from the end of the discharge hose. This location is used to fill water and irrigation trucks operated by the City.

5.1.2.1.7 Land Use and Hydrologic Characteristics of Monitored Stormwater Basins

A summary of land use characteristics in the monitored stormwater basins is given in Table 5-4. Sub-basins MI-1 and MI-2 consist of a mixture of commercial and medium-density residential land use, along with associated roadways and parking areas. Sub-basin MI-3 consists primarily of commercial and multi-family, with medium-density residential comprising the dominant land use at site MI-4 and commercial/industrial activities at site MI-5.



Figure 5-15.

Photograph of the Reuse
Monitoring Site.

TABLE 5-4

**SUMMARY OF LAND USE CHARACTERISTICS
IN THE MONITORED STORMWATER BASINS**

| SUB-BASIN | LAND USE | AREA (acres) |
|------------------|----------------------------|-------------------------|
| MI-1 | Commercial | 1.14 |
| | Highway | 2.83 |
| | Institutional | 3.56 |
| | Medium-Density Residential | 39.77 |
| | Recreational | 0.23 |
| MI-2 | Commercial | 4.28 |
| | Dry Ponds | 0.35 |
| | Medium-Density Residential | 16.87 |
| MI-3 | Multi-Family Residential | 7.26 |
| | Commercial | 4.46 |
| MI-4 | Multi-Family Residential | 5.30 |
| | Medium-Density Residential | 5.47 |
| MI-5 | Upland Hardwood Forests | 0.57 |
| | Industrial | 3.09 |
| TOTAL: | | 95.18 |

Hydrologic characteristics of the monitored stormwater basins are summarized on Table 5-5. The drainage basins have impervious areas ranging from 47.6-71.8%, although most of the impervious area is not considered to be directly connected due to the use of swale drainage systems throughout the area.

TABLE 5-5
HYDROLOGIC CHARACTERISTICS OF THE
MONITORED STORMWATER BASINS

| SUB-BASIN | TOTAL AREA (acres) | IMPERVIOUS | | DIRECTLY CONNECTED IMPERVIOUS | | PERVIOUS | |
|---------------|--------------------|--------------|-------------|-------------------------------|------------|--------------|-------------|
| | | Area (acres) | % | Area (acres) | % | Area (acres) | % |
| MI-1 | 47.53 | 22.61 | 47.6 | 0.20 | 0.4 | 24.92 | 52.4 |
| MI-2 | 28.76 | 16.33 | 56.8 | 2.90 | 10.1 | 12.43 | 43.2 |
| MI-3 | 9.76 | 5.86 | 60.1 | 0.95 | 9.7 | 3.90 | 39.9 |
| MI-4 | 6.04 | 2.89 | 47.9 | 0.00 | 0.0 | 3.15 | 52.1 |
| MI-5 | 3.09 | 2.22 | 71.8 | 0.00 | 0.0 | 0.87 | 28.2 |
| TOTAL: | 95.18 | 49.91 | 52.4 | 4.05 | 4.3 | 45.27 | 47.6 |

5.1.2.2 Field and Laboratory Methods

Field personnel visited each runoff site on a weekly basis, or following significant rain events (> 0.5 inch), over the period from May-October 2020. Runoff samples at each runoff site were collected using an ISCO autosampler that generated flow-weighted composite samples. Samples were collected during positive discharge conditions in each stormsewer system which included both runoff and baseflow conditions in each stormsewer system. Field personnel downloaded the hydrologic data stored in each autosampler regarding runoff discharge rates and sample collection activities, retrieved collected samples, and replaced the sample bottle with a pre-cleaned container. The battery power supplies were checked and each unit was recalibrated.

Collected samples of runoff and reuse were transported to the ERD Laboratory for analysis of general parameters and nutrients. The ERD Laboratory is NELAC accredited (#E1031026) for environmental parameters, microbiological parameters, and metals. A summary of analysis methods and minimum detection limits (MDLs) for analyses conducted in the ERD Laboratory was given in Table 2-9.

5.1.2.3 Characteristics of Monitored Runoff and Reuse Samples

A complete listing of the chemical characteristics of individual runoff samples collected at the Marco Island monitoring sites during the field monitoring program is given in Appendix F-2, including summary descriptive statistics, with the characteristics of reuse samples provided in Appendix F-3. Measured concentrations are provided for both stormwater and baseflow samples. Stormwater or runoff samples reflect the flow-weighted characteristics of water discharging through the stormsewer systems during rain events. Baseflow samples reflect a combination of tidal water inflows discharging from high to low tide plus infiltration into the stormsewer system from watershed areas. These baseflow inputs are part of the volumetric seepage inflows calculated in Section 4.1.4 except the inflows occur through a stormsewer rather than by groundwater. However, chemical characteristics of baseflow can provide additional information on groundwater impacts from watershed sources. A discussion of chemical characteristics of runoff and reuse samples collected at each of the monitoring sites is given in the following sections.

A tabular summary of geometric mean values for runoff, baseflow, and reuse samples collected during the field monitoring program from June-October 2020 is given in Table 5-6. The number of samples collected at each site is provided in the bottom row of the table. The field monitoring program generated a total of 43 baseflow samples (BF), 36 stormwater samples (SW), and 24 reuse samples (Reuse).

TABLE 5-6

GEOMETRIC MEAN VALUES FOR STORMWATER AND REUSE SAMPLES COLLECTED AT MARCO ISLAND FROM JUNE-OCTOBER 2020

| PARAMETER | UNITS | SITE | | | | | | | | | | |
|---------------------------|---------|-----------|----------|-----------|----------|----------|-----------|----------|----------|----------|-----------|-----------|
| | | MI-1 | | MI-2 | | MI-3 | | MI-4 | | MI-5 | | REUSE |
| | | BF | SW | BF | SW | BF | SW | BF | SW | BF | SW | |
| pH | s.u. | 7.73 | 6.90 | 7.79 | 7.48 | 7.16 | 7.50 | 7.76 | 7.64 | 7.91 | 7.68 | 7.36 |
| Alkalinity | mg/l | 125 | 71.8 | 132 | 67.5 | 183 | 67.3 | 139 | 98.5 | 169 | 67.4 | 99.1 |
| Conductivity | µmho/cm | 33,080 | 500 | 44,290 | 1,692 | 28,795 | 652 | 25,897 | 843 | 29,977 | 510 | 1,397 |
| Ammonia N | µg/l | 47 | 8 | 10 | 8 | 816 | 105 | 176 | 111 | 29 | 30 | 11 |
| NO _x -N | µg/l | 137 | 103 | 17 | 17 | 22 | 117 | 194 | 165 | 237 | 51 | 3,263 |
| Diss. Organic N | µg/l | 640 | 339 | 579 | 372 | 524 | 785 | 598 | 742 | 521 | 378 | 1,205 |
| Particulate N | µg/l | 90 | 156 | 54 | 71 | 154 | 121 | 218 | 80 | 61 | 62 | 150 |
| Total N | µg/l | 915 | 606 | 660 | 467 | 1,516 | 1,128 | 1,186 | 1,098 | 848 | 521 | 4,629 |
| SRP | µg/l | 75 | 122 | 79 | 89 | 76 | 76 | 204 | 228 | 157 | 66 | 2,300 |
| Diss. Organic P | µg/l | 22 | 40 | 22 | 24 | 49 | 101 | 71 | 107 | 45 | 80 | 845 |
| Particulate P | µg/l | 14 | 43 | 20 | 23 | 45 | 51 | 56 | 85 | 15 | 26 | 121 |
| Total P | µg/l | 110 | 206 | 121 | 135 | 170 | 227 | 331 | 420 | 218 | 172 | 3,267 |
| Turbidity | NTU | 7.2 | 8.3 | 1.4 | 1.9 | 6.7 | 4.4 | 4.6 | 13.8 | 3.3 | 7.0 | 0.3 |
| Color | Pt-Co | 22 | 36 | 11 | 20 | 46 | 38 | 31 | 62 | 31 | 31 | 5 |
| TSS | mg/l | 14.9 | 35.3 | 5.0 | 9.7 | 9.7 | 8.4 | 16.2 | 26.7 | 5.5 | 7.5 | 0.3 |
| NUMBER OF SAMPLES: | | 11 | 3 | 11 | 5 | 7 | 10 | 9 | 8 | 5 | 10 | 24 |

Samples of baseflow, stormwater, and reuse collected at each of the monitoring sites was approximately neutral to slightly alkaline in pH, with geometric mean pH values ranging from 6.9-7.91. The collected baseflow samples exhibited elevated alkalinity values in excess of 125 mg/l, indicating well buffered conditions and likely impacts from tidal waters. Measured alkalinity values in stormwater and reuse samples ranged from approximately 60-100 mg/l, reflecting moderate to well buffered conditions.

A statistical summary of measured values of pH, alkalinity, and conductivity in baseflow, runoff, and reuse samples collected at the Marco Island monitoring sites from May-October 2020 is given on Figure 5-16 in the form of Tukey Box Plots, also often called “Box and Whisker Plots”. The bottom of the box portion of each plot represents the lower quartile, with 25% of the data points falling below this value. The upper line of the box represents the 75% upper quartile, with 25% of the data falling above this value. The blue horizontal line within the box represents the median value, with 50% of the data falling both above and below this value. The vertical lines, also known as "whiskers", represent the 10 and 90 percentiles for the data sets. Individual values which fall outside of the 10-90 percentile range are indicated as red dots.

A relatively modest degree of variability was observed in measured values for pH, particularly for the reuse and baseflow samples. Variability in measured pH values was slightly higher for collected stormwater samples at sites MI-1, MI-3, and MI-5. In contrast, a much higher degree of variability was observed for measured alkalinity values, although reuse and baseflow samples at sites MI-1 and MI-2 exhibited a high concentration but a low degree of variability for this parameter. Measured alkalinity in stormwater samples ranged from approximately 50->250 mg/l, depending upon the individual sample. Overall, alkalinity measurements in baseflow exhibited a generally lower degree of variability than alkalinity values in runoff.

A large degree of variability was observed in measured conductivity values between the monitored sources. In general, conductivity values for stormwater and reuse were less than approximately 1,500-2,000 $\mu\text{mho/cm}$. In contrast, extremely elevated levels of conductivity were observed in baseflow samples, indicating the significance of tidal flushing on baseflow characteristics. Measured geometric mean conductivity values at the 5 monitoring sites ranged from approximately 25,000-45,000, compared with values of approximately 55,000 $\mu\text{mho/cm}$ for pure sea water.

A statistical summary of measured values for turbidity, color, and TSS in baseflow, runoff, and reuse samples collected at the Marco Island monitoring sites from May-October 2020 is given on Figure 5-17. In general, measured turbidity values were low at each of the monitoring sites, although relatively extreme values were observed on occasion at certain sites. The largest degree of variability in turbidity measurements appear to occur at site MI-1 which is the low maintenance residential watershed monitored at the intersection of 6th Avenue and Yellowbird Street. Construction activities were underway at this site during a portion of the field monitoring program which appears to be the likely explanation for the more elevated turbidity values measured in runoff and baseflow collected at this site. Turbidity values in the reuse samples were consistently less than 1 NTU.

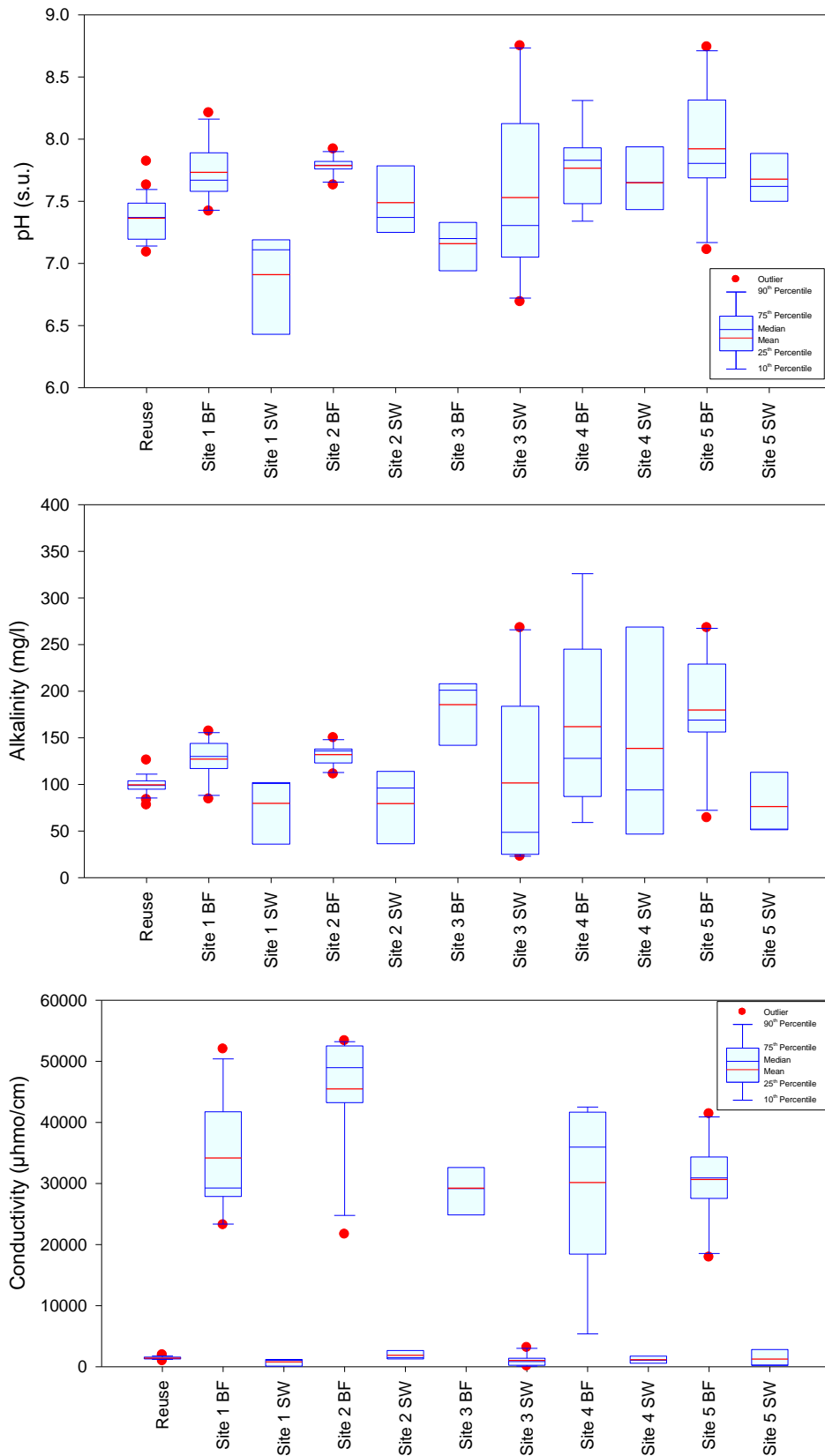

Figure 5-16. Statistical Summary of Measured Values for pH, Alkalinity, and Conductivity in Baseflow, Runoff, and Reuse Samples Collected at Marco Island Monitoring Sites from May-October 2020.

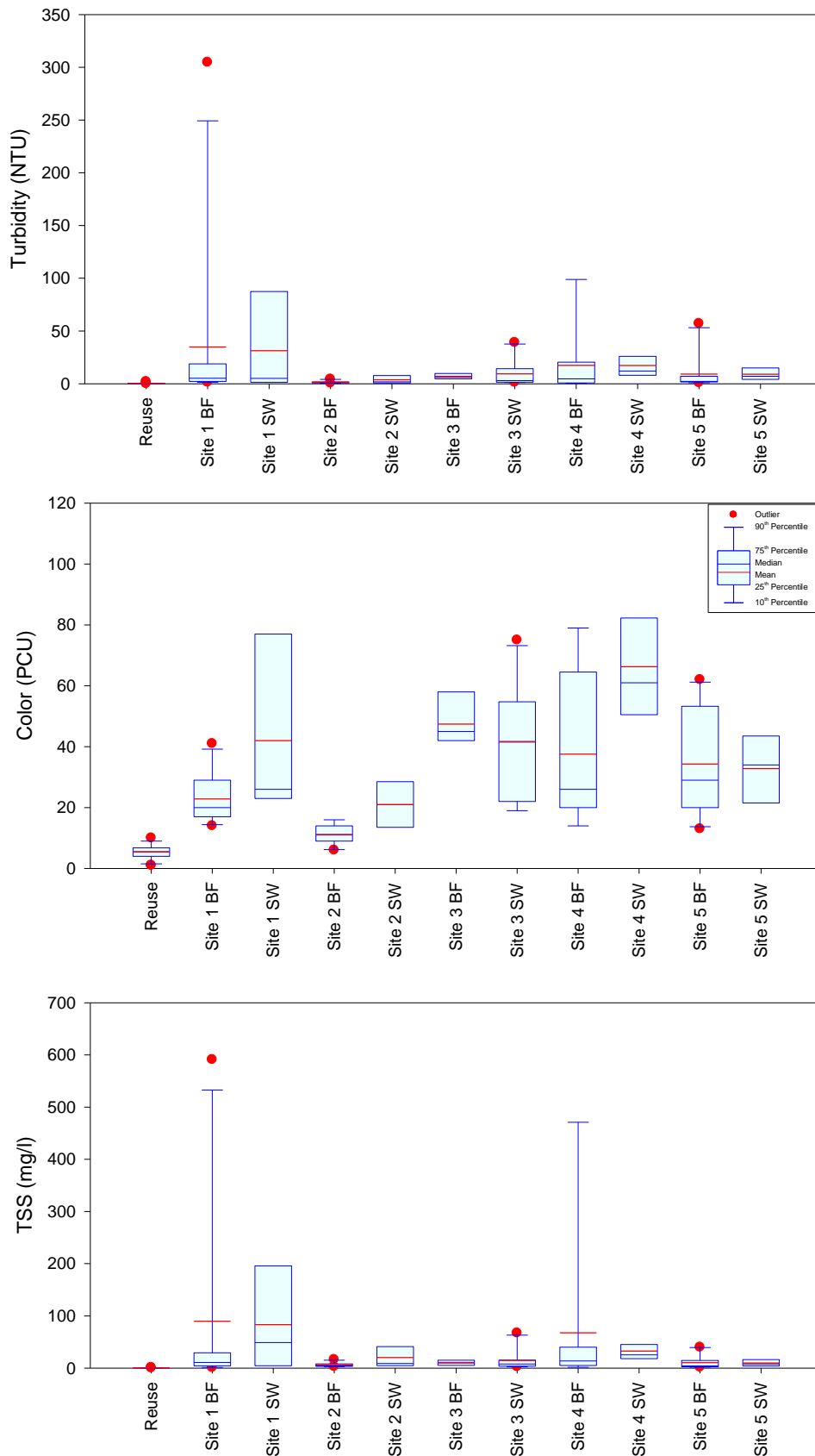

Figure 5-17. Statistical Summary of Measured Values for Turbidity, Color, and TSS in Baseflow, Runoff, and Reuse Samples Collected at Marco Island Monitoring Sites from May-October 2020.

A relatively high range of color values was observed at the monitoring sites, with overall color values ranging from low to slightly elevated. Reuse samples were generally characterized by low levels of color less than approximately 5 Pt-Co units. Geomean color concentrations exceeding 40 Pt-Co units were observed in baseflow samples at site MI-3 and stormwater samples at site MI-4. The somewhat elevated values for color observed in some of the stormwater and baseflow samples is unusual, since urban runoff is typically characterized by relatively low color values.

Measured concentrations of TSS at the Marco Island monitoring sites exhibits a trend similar to that observed for turbidity. In general, the vast majority of measured TSS concentrations were low in value, although more elevated values were observed on some occasions at certain sites. The most elevated TSS values appear to occur for both baseflow and stormwater at site MI-1 which was impacted by construction activities during a portion of the field monitoring program. However, excluding site MI-1, TSS concentrations measured at the remaining sites appear to be low in value compared with concentrations commonly observed in urban runoff. The observed lower values for TSS are likely related to the existing swale drainage system present in many portions of the island which serves as a pre-treatment for runoff, particularly for suspended solids, prior to reaching the stormsewer system.

A statistical summary of measured concentrations of ammonia, NO_x , and dissolved organic nitrogen in baseflow, runoff, and reuse samples collected at Marco Island monitoring sites from May-October 2020 is given on Figure 5-18. A wide range of ammonia concentrations was observed between the individual monitoring sites. Relatively low levels of ammonia were measured in the reuse samples as well as baseflow and stormwater samples collected at sites MI-1, MI-2, and to a lesser degree at site MI-5. More elevated values for ammonia were observed in baseflow and stormwater samples collected from sites MI-3 and MI-4 which reflect a commercial area with partial reuse and a highly maintained residential community. The elevated values for ammonia in baseflow samples collected at sites MI-3 and MI-4 suggest watershed sources of ammonia are entering the stormsewer system through groundwater.

Relatively low concentrations of NO_x were observed at each of the runoff and baseflow monitoring sites, with the possible exceptions of baseflow samples collected at sites MI-4 and MI-5, which also exhibited elevated ammonia concentrations. Substantially elevated concentrations of NO_x were measured in the collected reuse samples, with a geometric mean concentration of 3,263 $\mu\text{g}/\text{l}$, a value which is 1-2 orders of magnitude greater or more than geometric mean values at the remaining sites.

Measured concentrations of dissolved organic nitrogen were relatively similar between the individual monitoring sites, with the vast majority of measurements ranging from 100-800 $\mu\text{g}/\text{l}$. No distinct trends are apparent in either baseflow or stormwater samples. However, reuse samples exhibited a higher degree of variability in measured values for dissolved organic nitrogen although the mean value of 1,205 $\mu\text{g}/\text{l}$ is greater than mean values measured at the runoff sites.

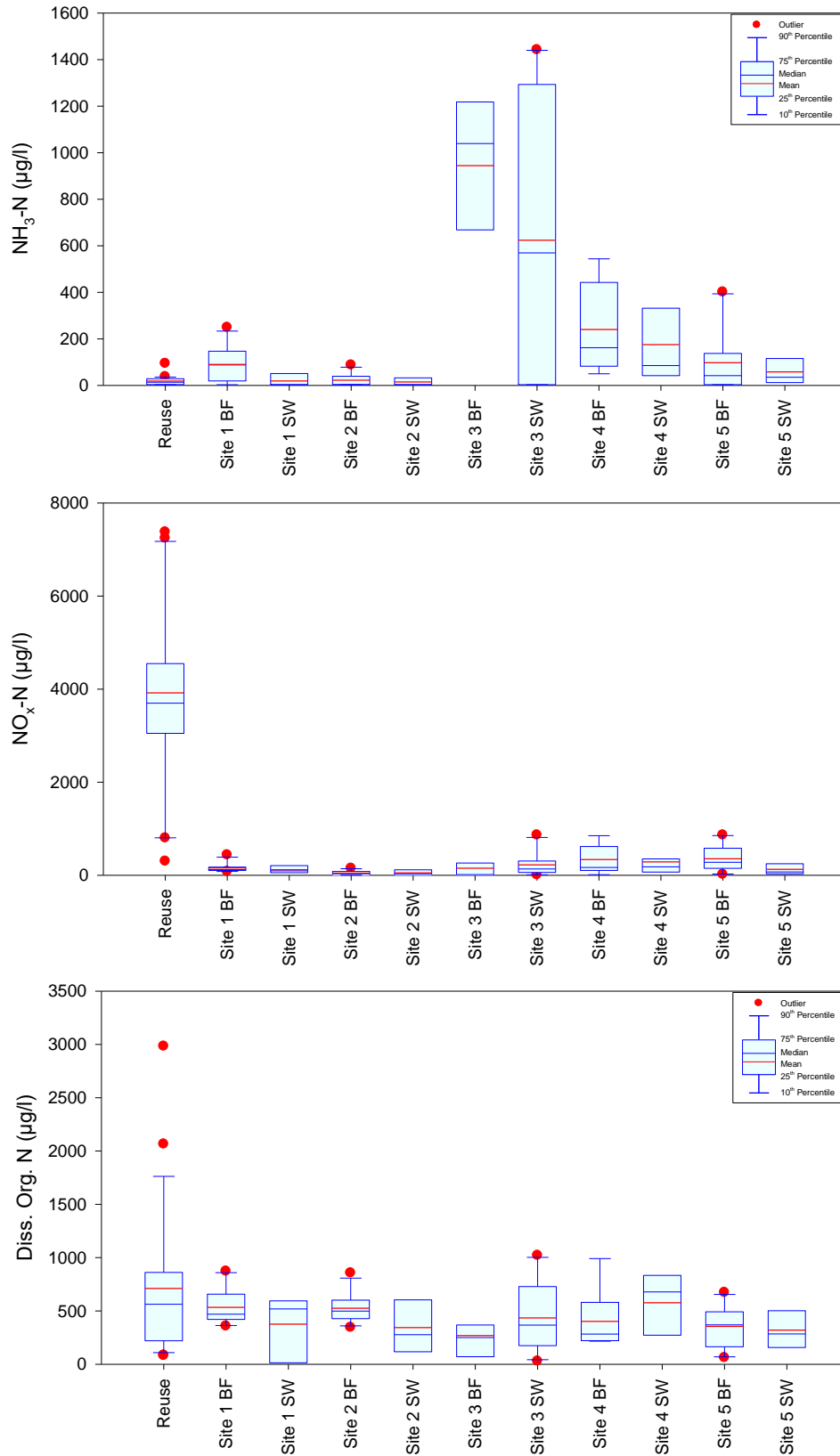

Figure 5-18. Statistical Summary of Measured Values for Ammonia, NO_x, and Dissolved Organic Nitrogen in Baseflow, Runoff, and Reuse Samples Collected at Marco Island Monitoring Sites from May-October 2020.

A statistical summary of measured values for particulate nitrogen and total nitrogen in baseflow, runoff, and reuse samples collected at Marco Island monitoring sites from May-October 2020 is given on Figure 5-19. Measured concentrations of particulate nitrogen were generally low to moderate in value, although more elevated values were observed on several occasions at some sites. Geometric mean particulate nitrogen concentrations were generally 150 µg/l or less, with the exception of baseflow samples collected at site MI-4 which had a geometric mean of 218 µg/l. The geometric mean values for particulate nitrogen are somewhat lower than values commonly observed in urban runoff, and these lower values are likely due to pre-treatment impacts from the roadside swale drainage system.

Total nitrogen concentrations at the monitoring sites exhibit a moderate degree of variability although a higher degree of variability was observed in measured total nitrogen concentrations in the reuse samples and stormwater collected at site MI-3. Measured total nitrogen concentrations in stormwater samples appear to be substantially lower in value than total nitrogen concentrations commonly observed in urban runoff from similar land use types, and these lower observed values are likely related to the swale pre-treatment system. The most elevated total nitrogen concentrations were observed at sites MI-3 and MI-4, with site MI-3 representing a commercial area with partial reuse and site MI-4 reflecting a high maintenance residential community. Total nitrogen concentrations in reuse samples ranged from 1,633-8,507 µg/l, with an overall geometric mean value of 4,629 µg/l.

A statistical summary of measured values of SRP and dissolved organic phosphorus in baseflow, runoff, and reuse samples collected at Marco Island monitoring sites from May-October 2020 is given on Figure 5-20. In general, measured concentrations of SRP were low to moderate in runoff and baseflow samples, with the most elevated SRP values for both baseflow and stormwater measured in the high maintenance residential area monitored at site MI-4. SRP concentrations in reuse were highly variable, ranging from 531-4,708 µg/l, with an overall geometric mean of 2,300 µg/l.

A similar pattern is also apparent for measured concentrations of dissolved organic phosphorus, with relatively low measured values at each of the baseflow and stormwater monitoring sites, and a higher overall geometric mean value in reuse samples. The measured concentrations of dissolved organic phosphorus in the reuse samples were often an order of magnitude greater than concentrations measured in baseflow or reuse.

A statistical summary of measured values of particulate phosphorus and total phosphorus in baseflow, runoff, and reuse samples collected at Marco Island monitoring sites from May-October 2020 is given on Figure 5-21. Measured concentrations of particulate phosphorus in baseflow and stormwater samples were generally low in value and lower than concentrations commonly observed in urban runoff from similar land use categories. The lower observed values for particulate phosphorus are thought to be a direct result of pre-treatment and removal of particulate matter in the swale drainage system prior to reaching the stormsewer. Measured concentrations of particulate phosphorus were highly variable in stormwater at site MI-3 and in baseflow at site MI-4, with a variability similar to that observed in reuse samples, although the geometric mean for the reuse samples is substantially higher.

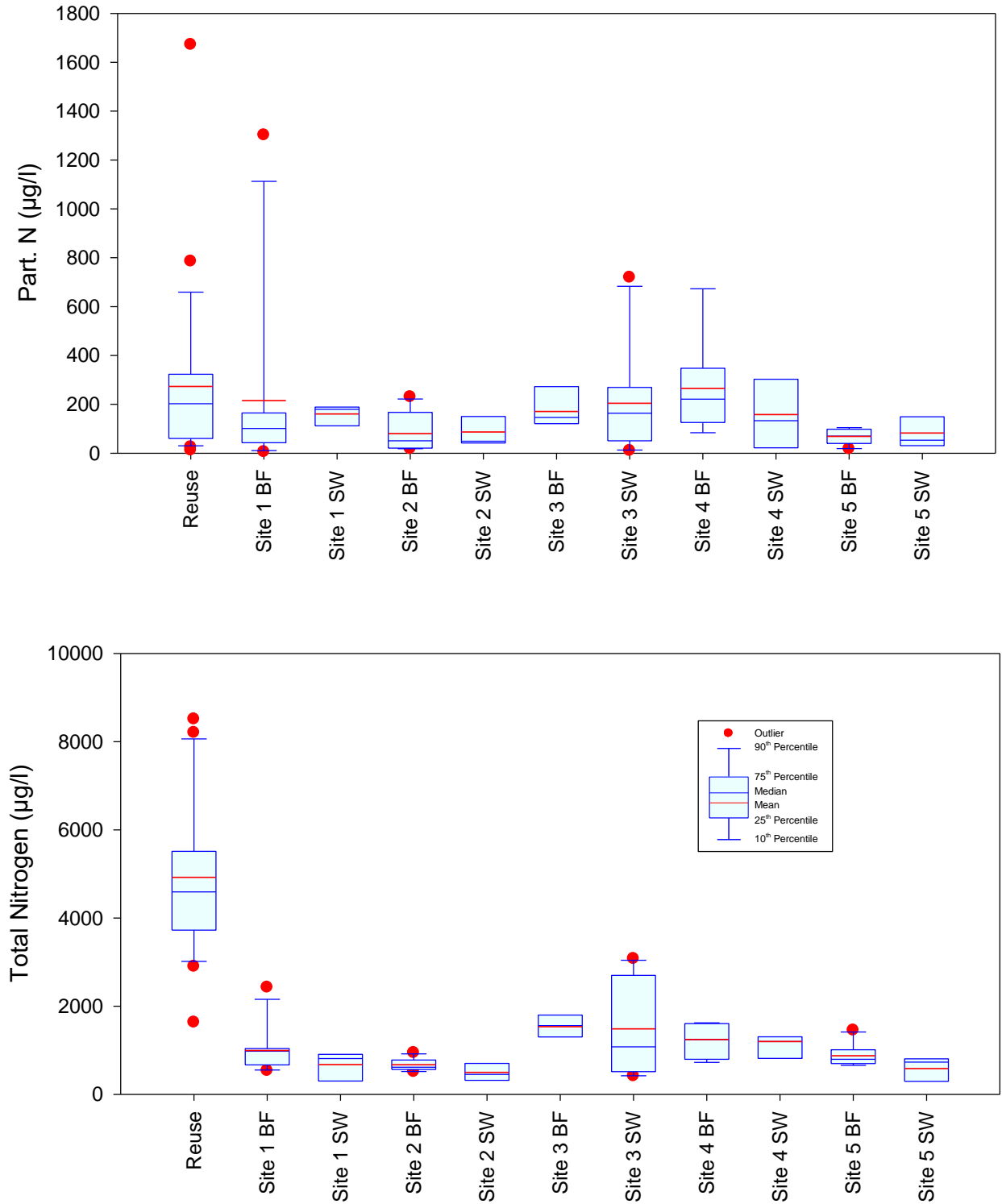

Figure 5-19. Statistical Summary of Measured Values for Particulate Nitrogen and Total Nitrogen in Baseflow, Runoff, and Reuse Samples Collected at Marco Island Monitoring Sites from May-October 2020.

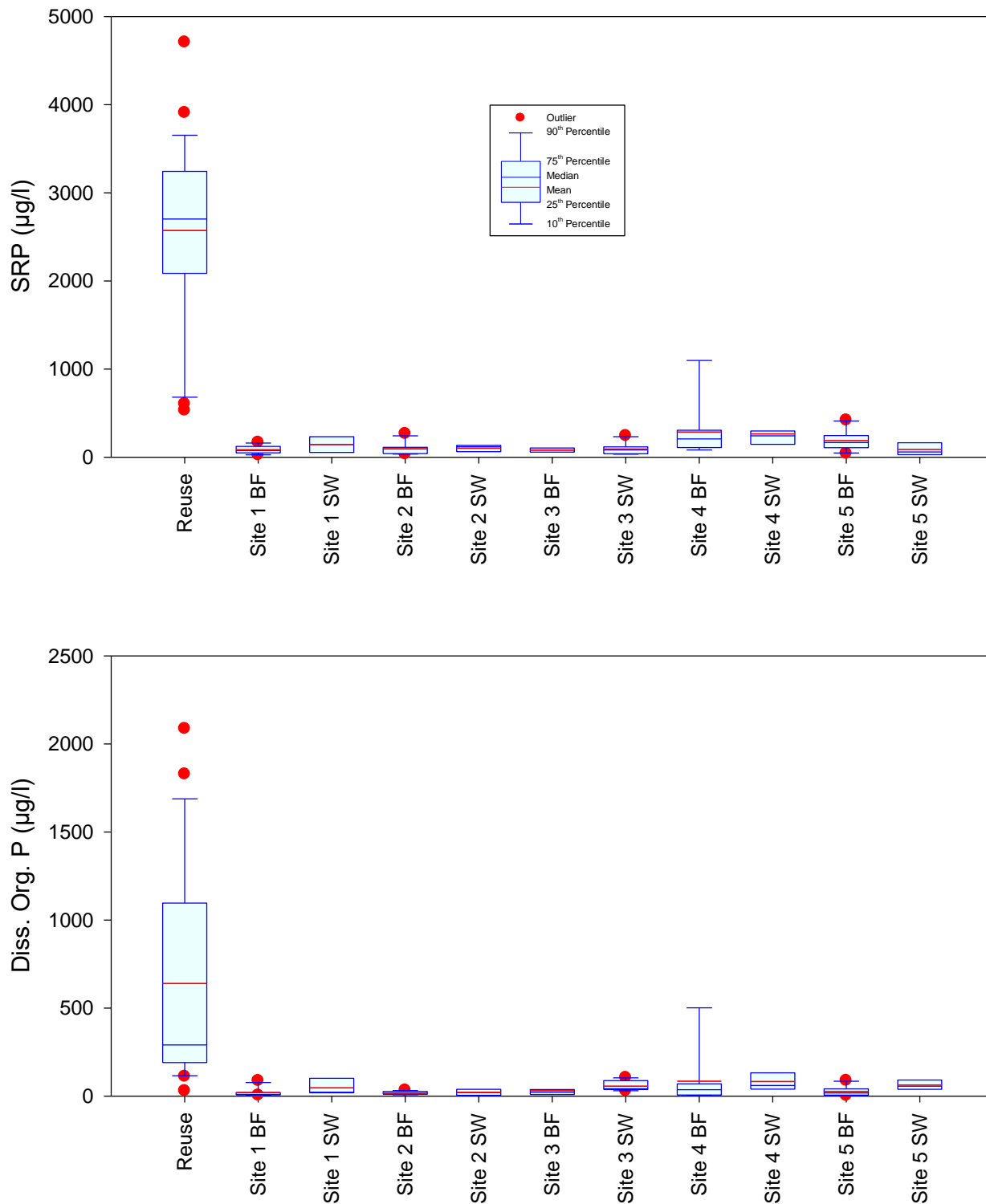

Figure 5-20. Statistical Summary of Measured Values for SRP and Dissolved Organic Phosphorus in Baseflow, Runoff, and Reuse Samples Collected at Marco Island Monitoring Sites from May-October 2020.

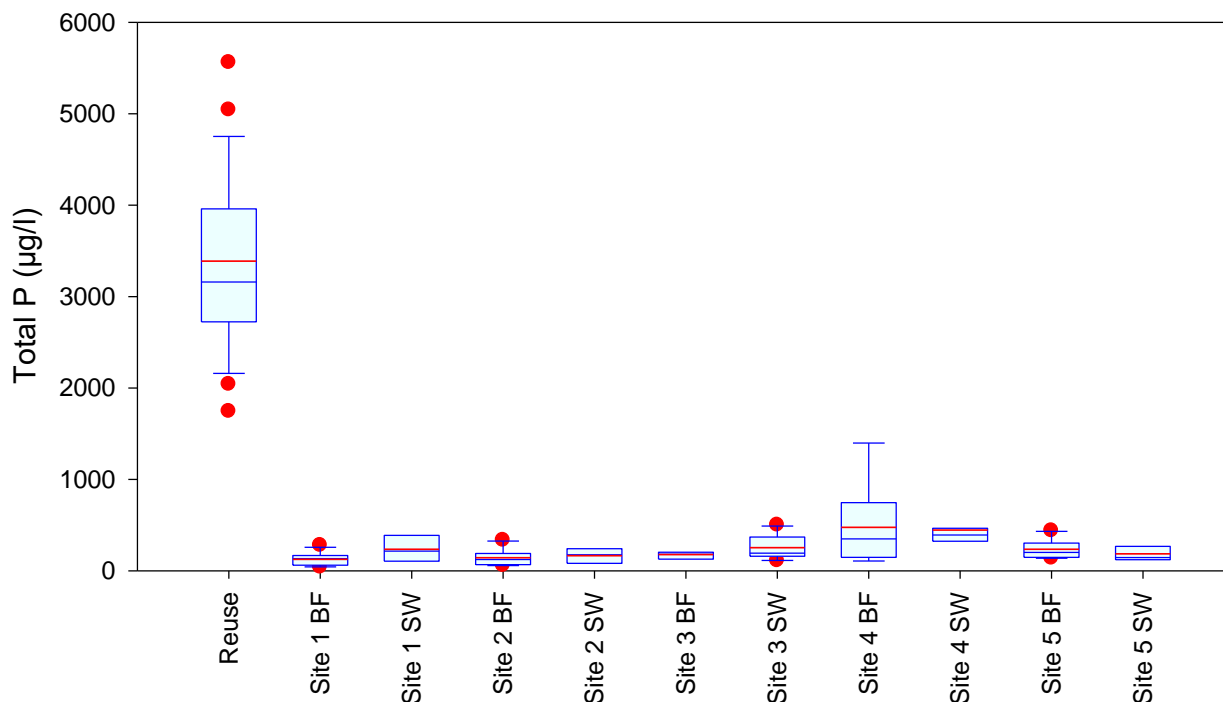
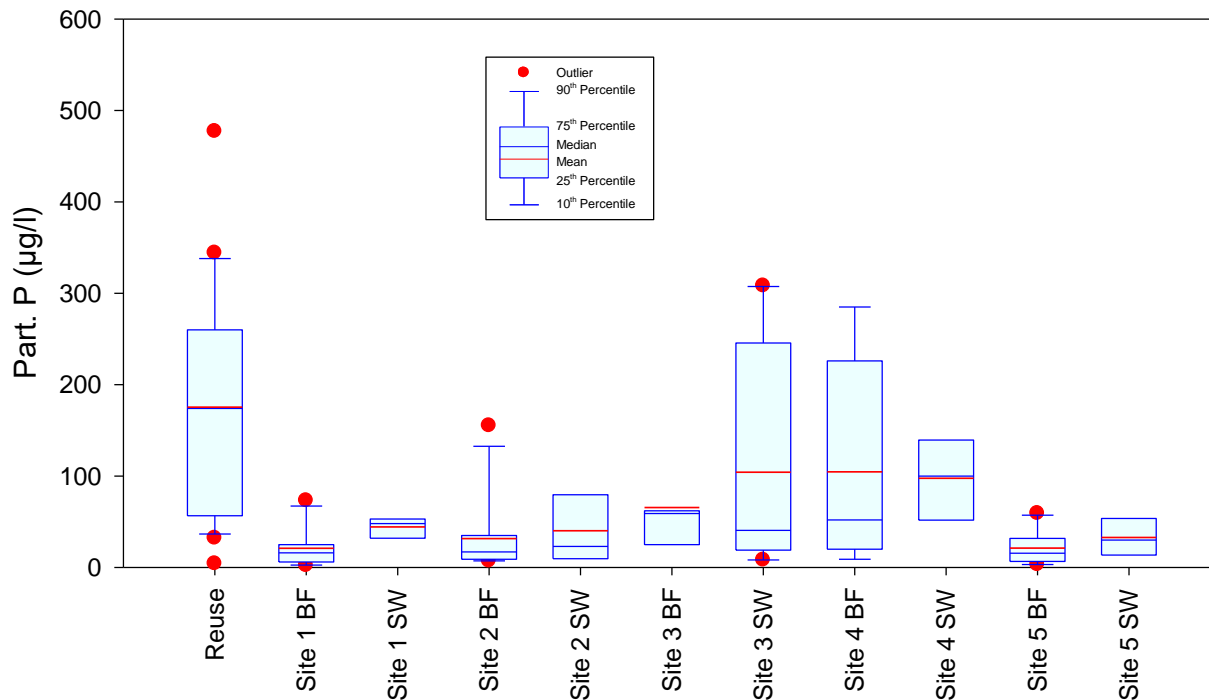

Figure 5-21. Statistical Summary of Measured Values for Particulate Phosphorus and Total Phosphorus in Baseflow, Runoff, and Reuse Samples Collected at Marco Island Monitoring Sites from May-October 2020.

Relatively low concentrations were also observed for total phosphorus concentrations in baseflow and stormwater samples, with geometric mean values at most sites less than values commonly observed in urban runoff from similar land uses. The most elevated levels of total phosphorus were observed in baseflow and stormwater collected in the high maintenance residential watershed at site MI-4, and measured values at these sites exceed typical runoff concentrations observed in residential areas. Substantially higher total phosphorus concentrations were observed in the reuse samples as well as a high degree of variability between individual measurements. Overall, the geometric total phosphorus concentration of 3,267 µg/l in reuse water is an order of magnitude or more greater than total phosphorus concentrations observed at most sites.

5.1.2.4 Selection of Runoff Characterization Data

The primary objective of the field monitoring program is to provide site-specific information on concentrations of total nitrogen and total phosphorus from stormwater runoff to adjacent waterways to assist in calculating annual mass loadings. Runoff loadings to receiving waters are calculated using the simple relationship below:

$$\text{Annual Runoff Loading} = \text{Delivered Runoff Volume} \times \text{Assumed Runoff Concentration}$$

Calculations of annual runoff volumes discharging from sub-basin areas to Marco Island waterways were previously provided in Section 4.

Direct field monitoring for runoff characteristics were conducted in each of the 5 sub-basin areas identified in Section 3 which discharge to Marco Island waterways, with 1 monitoring site located in each of the 5 sub-basin areas. Although the 5 sub-basin areas contain a variety of land use categories, as discussed in Section 3.2, it is not feasible to monitor all of the combinations of land use categories present within the various drainage sub-basin areas.

A tabular comparison of geometric mean values for parameters measured in stormwater samples collected at each of the 5 monitoring sites is given in Table 5-7, based upon the information provided in Table 5-6. Geometric mean values for total nitrogen in runoff samples collected in sub-basins 2, 3, and 4 are very similar in value and approximately one-half to one-third of total nitrogen concentrations typically observed in similar land use categories, presumably due to the large amount of swale drainage systems present within the island. It is interesting to note that the most elevated levels of ammonia, NO_x, dissolved organic nitrogen, and total nitrogen were observed in Sub-basin 1 (monitoring Site MI-3) located in a commercial corridor along Bald Eagle Drive with partial reuse irrigation, and in Sub-basin 5 (Site MI-4) located in an area of large residential homes with well maintained lawns. Concentrations of these same parameters at monitoring sites in Sub-basins 2 and 4 which had reuse irrigation were much lower in value and similar to nitrogen concentrations measured in Sub-basin 3 which has no reuse irrigation.

With the exception of the enrichment in ammonia, NO_x, dissolved organic nitrogen, and total nitrogen observed in Sub-basin 1, application of reuse irrigation does not appear to have significant direct impacts on runoff characteristics which suggests that excess reuse irrigation rapidly infiltrates into groundwater and is unavailable for transport during rain events. The most elevated values for ammonia, NO_x, dissolved organic nitrogen, and total nitrogen were observed in Sub-basin 5 in an area with large homes and well maintained lawns. These data appear to suggest that landscaping activities may have a more significant impact on runoff concentrations of total nitrogen than reuse applications, although the data set is fairly limited.

TABLE 5-7

**SUMMARY OF GEOMEAN VALUES FOR
STORMWATER MONITORING SITES**

| PARAMETER | UNITS | RUNOFF CONCENTRATION BY SITE | | | | |
|------------------------------|---------|------------------------------|------------|----------------|-----------|------------|
| | | MI-1 | MI-2 | MI-3 | MI-4 | MI-5 |
| pH | s.u. | 6.90 | 7.48 | 7.50 | 7.64 | 7.68 |
| Alkalinity | mg/l | 71.8 | 67.5 | 67.3 | 98.5 | 67.4 |
| Conductivity | µmho/cm | 500 | 1,692 | 652 | 843 | 510 |
| Ammonia N | µg/l | 8 | 8 | 105 | 111 | 30 |
| NO _x -N | µg/l | 103 | 17 | 117 | 165 | 51 |
| Diss. Organic N | µg/l | 163 | 267 | 308 | 494 | 261 |
| Particulate N | µg/l | 156 | 71 | 121 | 80 | 62 |
| Total N | µg/l | 606 | 467 | 1,128 | 1,098 | 521 |
| SRP | µg/l | 122 | 89 | 76 | 228 | 66 |
| Diss. Organic P | µg/l | 35 | 14 | 51 | 65 | 57 |
| Particulate P | µg/l | 43 | 23 | 51 | 85 | 26 |
| Total P | µg/l | 206 | 135 | 227 | 420 | 172 |
| Turbidity | NTU | 8.3 | 1.9 | 4.4 | 13.8 | 7.0 |
| Color | Pt-Co | 36 | 20 | 38 | 62 | 31 |
| TSS | mg/l | 35.3 | 9.7 | 8.4 | 26.7 | 7.5 |
| NUMBER OF SAMPLES: | | 3 | 5 | 10 | 8 | 10 |
| ASSOCIATED SUB-BASIN: | | 3 | 4 | 1 | 5 | 2 |
| REUSE IRRIGATION: | | No | Yes | Partial | No | Yes |

A similar situation appears to also exist for total phosphorus. Measured concentrations of total phosphorus in Sub-basins 2, 3, and 4 are relatively similar in value, with more elevated concentrations observed in Sub-basins 1 and 5, with the highest value of 420 µg/l observed in Sub-basin 5. Stormwater samples collected from Sub-basin 5 also had substantially higher levels of SRP, dissolved organic phosphorus, and particulate phosphorus than observed at the remaining sites, including those with reuse irrigation. Phosphorus data also appear to suggest that landscaping activities have more of an impact on phosphorus runoff concentrations than reuse application.

For purposes of estimating annual runoff generated loadings of nitrogen and phosphorus to area waterways, the geometric mean values for total nitrogen and total phosphorus (summarized on Table 5-7) are assumed to reflect typical runoff characteristics generated within each associated sub-basin area. The geometric mean concentrations for nitrogen and phosphorus listed in Table 5-7 are multiplied by the applicable delivered runoff volumes (summarized in Table 4-6) to obtain estimates of annual nutrient loadings from runoff to Marco Island waterways.

5.1.2.5 Runoff Loadings

A tabular summary of runoff generated nutrient loadings to Marco Island waterways, based on the methodology outlined previously, is given in Table 5-8. Estimated mass loadings for total nitrogen and total phosphorus are calculated by multiplying the assumed sub-basin runoff characteristics (summarized in Table 5-7) times the delivered runoff volume reaching each of the 5 waterways on an annual basis. The lowest annual loading of nitrogen and phosphorus from runoff to area waterways occurs in Sub-basin 2 which only generates approximately 4-5% of the total annual runoff loadings. The largest runoff generated contribution of total nitrogen originates within Sub-basin 1, which contributes 45% of the annual nitrogen load from runoff. The largest contribution of total phosphorus occurs from Sub-basin 5 which generates 33% of the total annual runoff generated phosphorus loading.

TABLE 5-8
CALCULATED ANNUAL AND AREAL LOADINGS
OF TOTAL NITROGEN AND TOTAL PHOSPHORUS FROM
SUB-BASIN AREAS TO MARCO ISLAND WATERWAYS

| SUB-BASIN | AREA (acres) | DELIVERED RUNOFF VOLUME (ac-ft/yr) | ASSUMED RUNOFF CONCENTRATION (µg/l) | | MASS LOADING (kg/yr) | | PERCENT OF ANNUAL LOAD (%) | | AREAL LOADING (kg/ac-yr) | |
|---------------|-----------------|---|--|---------------------|-------------------------|---------------------|----------------------------------|---------------------|-----------------------------|---------------------|
| | | | Total Nitrogen | Total Phosphorus | Total Nitrogen | Total Phosphorus | Total Nitrogen | Total Phosphorus | Total Nitrogen | Total Phosphorus |
| 1 | 1469.4 | 429.4 | 1,128 | 227 | 2,043 | 411 | 45 | 32 | 1.39 | 0.28 |
| 2 | 306.2 | 94.3 | 521 | 172 | 197 | 65 | 4 | 5 | 0.64 | 0.21 |
| 3 | 895.5 | 147.6 | 606 | 206 | 669 | 227 | 15 | 18 | 0.75 | 0.25 |
| 4 | 942.4 | 206.9 | 467 | 135 | 543 | 157 | 12 | 12 | 0.58 | 0.17 |
| 5 | 814.6 | 133.0 | 1,098 | 420 | 1,103 | 422 | 24 | 33 | 1.35 | 0.52 |
| TOTAL: | 4,428.1 | 1,011.3 | | | 4,555 | 1,282 | 100 | 100 | 1.03 | 0.29 |

Calculated areal loading rates for each sub-basin are provided in the final column of Table 5-8. The values were obtained by dividing the annual mass loadings for each sub-basin by the sub-basin area which provides a comparison of pollutant loadings which is independent of the size of an individual sub-basin. The highest annual areal loadings of both total nitrogen and total phosphorus occur from Sub-basins 1 and 5 which are located on opposite ends of the island. Areal loading rates in the remaining 3 sub-basins are relatively similar in value for both total nitrogen and total phosphorus, with loading rates lower than those observed in Sub-basins 1 and 5. The information summarized in Table 5-8 is used in a subsequent section to generate nutrient budgets for the 5 sub-basins and adjacent waterway areas.

5.1.3 Groundwater Seepage

5.1.3.1 Chemical Characteristics of Seepage Inflows

Nutrient influx to Marco Island waterways from groundwater seepage was quantified using a series of underwater seepage meters installed throughout the various waterways. A discussion of the hydrologic inputs to adjacent waterways from groundwater seepage is given in Section 4.1.4. Each of the collected groundwater seepage samples was analyzed in the ERD Laboratory for pH, alkalinity, conductivity, and significant species for nitrogen and phosphorus using the analytical methods outlined in Table 2-5 for surface water samples. A summary of geometric mean characteristics of seepage inflows at the Marco Island monitoring sites from April-November 2020 is given in Table 5-9, and a complete listing of laboratory measurements conducted on seepage samples collected from Marco Island waterways is given in Appendix E-2.

TABLE 5-9

**GEOMETRIC MEAN CHARACTERISTICS OF SEEPAGE
INFLOWS AT MARCO ISLAND FROM APRIL-NOVEMBER 2020**

| SITE | NUMBER OF SAMPLES | PARAMETER | | | | | | | | | |
|---------------|-------------------|-----------|-------------------|------------------------|------------------|---------------------------|---------------------|----------------|------------|---------------------|----------------|
| | | pH (s.u.) | Alkalinity (mg/l) | Conductivity (µmho/cm) | Ammonia N (µg/l) | NO _x -N (µg/l) | Diss. Org. N (µg/l) | Total N (µg/l) | SRP (µg/l) | Diss. Org. P (µg/l) | Total P (µg/l) |
| SP-1 | 4 | 7.45 | 139 | 46,091 | 128 | 542 | 365 | 1,035 | 96 | 56 | 152 |
| SP-2 | 5 | 7.72 | 143 | 43,563 | 183 | 240 | 738 | 1,161 | 97 | 54 | 151 |
| SP-3 | 5 | 7.56 | 138 | 46,034 | 145 | 147 | 737 | 1,030 | 84 | 52 | 136 |
| SP-4 | 5 | 7.70 | 145 | 46,971 | 360 | 217 | 696 | 1,272 | 209 | 50 | 259 |
| SP-5 | 4 | 7.72 | 136 | 45,106 | 161 | 167 | 810 | 1,137 | 85 | 17 | 101 |
| SP-6 | 4 | 7.49 | 302 | 41,872 | 2,139 | 106 | 570 | 2,814 | 171 | 43 | 214 |
| SP-7 | 3 | 7.80 | 149 | 44,913 | 43 | 280 | 712 | 1,035 | 51 | 115 | 166 |
| SP-8 | 5 | 7.61 | 159 | 44,813 | 296 | 308 | 938 | 1,542 | 220 | 39 | 259 |
| SP-9 | 4 | 7.89 | 143 | 46,596 | 49 | 218 | 484 | 751 | 109 | 18 | 127 |
| SP-10 | 5 | 7.65 | 165 | 47,028 | 1,061 | 497 | 887 | 2,445 | 303 | 70 | 373 |
| SP-11 | 5 | 7.73 | 145 | 46,895 | 67 | 159 | 680 | 905 | 59 | 61 | 119 |
| SP-12 | 5 | 7.87 | 155 | 44,045 | 77 | 193 | 500 | 770 | 79 | 85 | 164 |
| SP-13 | 4 | 7.82 | 153 | 43,526 | 278 | 216 | 523 | 1,017 | 119 | 56 | 175 |
| SP-14 | 5 | 7.69 | 145 | 48,479 | 450 | 536 | 449 | 1,436 | 194 | 75 | 269 |
| SP-15 | 5 | 7.76 | 154 | 47,288 | 123 | 261 | 688 | 1,072 | 120 | 44 | 164 |
| TOTAL: | 68 | | | | | | | | | | |

During the field monitoring program, a total of 68 individual seepage samples was collected for analysis of chemical characteristics at each of the 15 monitoring sites where seepage samples were collected. As discussed in Section 4.1.4, no seepage samples were collected at seepage site SP-16 due to vandalism of the multiple seepage meters installed at this site. The number of seepage samples collected at other monitoring sites ranged from 3 to the maximum number of 5.

In general, groundwater seepage entering Marco Island waterways is slightly alkaline in pH, with geometric mean pH values ranging from 7.45-7.89. Seepage samples were extremely well buffered, as would be expected given the proximity to ocean water, with geometric mean alkalinity values at most sites ranging from 136-165 mg/l, reflecting a narrow range of values. A somewhat higher mean alkalinity of 302 mg/l was measured at seepage site SP-6 which is located in a canal system adjacent to East Marco Bay.

Measured conductivity values between the individual monitoring sites were extremely close in value, with the vast majority of mean values ranging from 43,000-47,000 $\mu\text{mho/cm}$. A somewhat lower conductivity of 41,872 $\mu\text{mho/cm}$ was observed at seepage site SP-6.

Measured concentrations of nitrogen species were generally low in value at a majority of the seepage monitoring sites. Relatively low levels of ammonia were observed at all seepage sites with the exception of sites SP-6 and SP-10 which are also located in a canal system adjacent to East Marco Bay. Ammonia concentrations at these sites were approximately one order of magnitude greater than values measured at the remaining sites.

Relatively low concentrations were observed in seepage for both NO_x and dissolved organic nitrogen, with similar values for each parameter between the individual monitoring sites. The uniformity in values for these parameters is somewhat unusual based on the extensive previous experience of ERD in measuring seepage inflows to Florida waterbodies.

Overall, measured concentrations of total nitrogen in seepage inflows were low to slightly elevated in value. Mean total nitrogen concentrations at all sites except SP-6 and SP-10 were equal to or less than approximately 1,500 $\mu\text{g/l}$, with values at site SP-6 and SP-10 approximately 50-70% higher.

Measured concentrations of SRP, dissolved organic phosphorus, and total phosphorus were low in value at each of the seepage monitoring sites compared with concentrations observed by ERD in other waterbodies. The similarity in measured concentrations between the seepage monitoring sites and the degree of variability in measured values is unusual compared with previous monitoring conducted by ERD.

Overall, seepage inflows to Marco Island waterways contains low to moderate concentrations of both total nitrogen and total phosphorus compared with seepage values measured in other waters, although the concentrations for these parameters in seepage is much higher than concentrations measured in surface water samples.

A comparison of mean seepage characteristics by sub-basin is given in Table 5-10. Seepage characteristics appear to be similar between the individual sub-basins for each of the measured parameters, particularly for parameters such as NO_x, dissolved organic nitrogen, dissolved organic phosphorus, and total phosphorus. The geometric mean values summarized in Table 5-10 are assumed to reflect the characteristics of seepage inflows to waterbodies associated with each of the 5 sub-basin areas.

TABLE 5-10
MEAN SEEPAGE CHARACTERISTICS BY SUB-BASIN

| SUB-BASIN | NUMBER OF SAMPLES | PARAMETER | | | | | | | | | |
|-----------|-------------------|-----------|-------------------|------------------------|------------------|---------------------------|---------------------|----------------|------------|---------------------|----------------|
| | | pH (s.u.) | Alkalinity (mg/l) | Conductivity (µmho/cm) | Ammonia N (µg/l) | NO _x -N (µg/l) | Diss. Org. N (µg/l) | Total N (µg/l) | SRP (µg/l) | Diss. Org. P (µg/l) | Total P (µg/l) |
| 1 | 22 | 7.63 | 145 | 45,083 | 159 | 303 | 698 | 1,160 | 109 | 63 | 173 |
| 2 | 5 | 7.70 | 145 | 46,971 | 360 | 217 | 696 | 1,272 | 209 | 50 | 259 |
| 3 | 21 | 7.72 | 180 | 44,826 | 737 | 241 | 655 | 1,633 | 157 | 41 | 198 |
| 4 | 15 | 7.77 | 151 | 46,604 | 217 | 330 | 546 | 1,093 | 131 | 68 | 199 |
| 5 | 5 | 7.73 | 145 | 46,895 | 67 | 159 | 680 | 905 | 59 | 61 | 119 |

A comparison of mean seepage characteristics in areas with and without reuse irrigation is given on Table 5-11. As indicated on Figure 4-7, seepage monitoring sites designated as SP-3, SP-5, SP-8, and SP-13 are located in the vicinity of upland areas which receive reuse irrigation. Mean seepage characteristics at these sites with reuse irrigation are compared to the remaining sites which are not impacted by reuse irrigation activities. Chemical characteristics of seepage inflows in these areas are virtually identical, suggesting that the monitoring sites did not receive significant reuse inputs.

TABLE 5-11
MEAN SEEPAGE CHARACTERISTICS IN AREAS WITH AND WITHOUT REUSE IRRIGATION

| AREA | NUMBER OF SAMPLES | PARAMETER | | | | | | | | | |
|---------|-------------------|-----------|-------------------|------------------------|------------------|---------------------------|---------------------|----------------|------------|---------------------|----------------|
| | | pH (s.u.) | Alkalinity (mg/l) | Conductivity (µmho/cm) | Ammonia N (µg/l) | NO _x -N (µg/l) | Diss. Org. N (µg/l) | Total N (µg/l) | SRP (µg/l) | Diss. Org. P (µg/l) | Total P (µg/l) |
| With | 18 | 7.68 | 146 | 44,870 | 220 | 210 | 752 | 1,181 | 127 | 41 | 168 |
| Without | 50 | 7.06 | 149 | 41,979 | 390 | 271 | 564 | 1,225 | 124 | 56 | 180 |

5.1.3.2 Mass Loadings from Seepage Inflows

Estimates of annual loadings of total nitrogen and total phosphorus entering Marco Island waterways from groundwater seepage were calculated by multiplying the modeled seepage volumetric inflows to waterways associated with each sub-basin (as discussed in Section 4.1.4.3) times the mean seepage characteristics for total nitrogen and total phosphorus (summarized in Table 5-10). A summary of this analysis is given in Table 5-12. Seepage inflows contribute approximately 1,460-6,418 kg/yr to Marco Island waterways, depending upon the individual sub-basin. Total phosphorus contributions to the Marco Island waters from groundwater seepage ranged from 297-957 kg/yr, depending on sub-basin area. This information is used in a subsequent section to develop mean annual nutrient budgets for the waterways.

TABLE 5-12
CALCULATED ANNUAL SEEPAGE LOADING
TO MARCO ISLAND WATERWAYS

| SUB-BASIN | SEEPAGE INFLOW (ac-ft/yr) | SEEPAGE CONCENTRATION (µg/l) | | MASS LOADING (kg/yr) | |
|---------------|------------------------------|---------------------------------|---------|-------------------------|--------------|
| | | Total N | Total P | Total N | Total P |
| 1 | 4,487 | 1,160 | 173 | 6,418 | 957 |
| 2 | 931 | 1,272 | 259 | 1,460 | 297 |
| 3 | 2,932 | 1,633 | 198 | 5,905 | 716 |
| 4 | 3,020 | 1,063 | 199 | 3,959 | 741 |
| 5 | 2,477 | 905 | 119 | 2,764 | 363 |
| TOTAL: | 13,847 | | | 20,506 | 3,074 |

5.1.4 Internal Recycling

Quantification of sediment nutrient release as a result of internal recycling in waterbodies is difficult, and a variety of methods have been used by researchers to estimate this loading. One method which has been used in reservoirs is called the Mass Balance Method. This method is best suited to a waterbody with well defined inputs and outputs. A mass balance is then conducted on the waterbody over a one- to two-week period. An increase of nutrient mass within the waterbody, after accounting for inputs and losses, would suggest that a net internal loading has occurred. However, this method is inappropriate for use on Marco Island waterways since the waterways are tidally influenced which masks the concentration increases required for this method.

A method which has been used extensively in deep waterbodies is to measure changes in nutrient content in the hypolimnion of a stratified waterbody over an extended period of anoxia. The increase in nutrient mass within the stratified hypolimnion can then be directly correlated with sediment release rates. However, this method also appears inappropriate for use in Marco Island waterbodies since the waterbodies are relatively shallow, and development of a well-defined hypolimnion does not occur.

A third method of quantifying the internal loadings is through trophic state modeling. Using this approach, hydrologic and nutrient inputs are estimated from all quantifiable sources. A trophic state model is then developed to predict water column concentrations of nutrients. If the model underestimates nutrient concentrations, then a missing nutrient load may be present which can be attributed to internal recycling. However, this methodology can be highly inaccurate, is dependent upon the accuracy of the estimated loadings for other variables and the accuracy of the predictive model, and is difficult in a tidally influenced waterbody.

The final method used for quantification of internal loadings is to perform sediment release experiments. In this method, large diameter sediment cores are collected from various locations within the waterbody and incubated in the laboratory under a variety of conditions to simulate variability in the waterbody throughout the year. Changes in nutrient concentrations are measured in the overlying sediments, and this information is extrapolated to an areal release rate within the waterbody. This is the only method of estimating internal loadings which provides a direct measurement of nutrient release. This method has been used by ERD in more than 60 Florida waterbodies in previous work efforts and was selected as the quantification method for the Marco Island study.

Field and laboratory investigations were performed by ERD to quantify the mass of nitrogen and phosphorus released as a result of internal recycling from the sediments to the overlying water column in Marco Island waterbodies under both aerobic and anoxic conditions. Large diameter sediment core samples were collected at multiple locations in the waterbodies and incubated under anoxic and aerobic conditions. Periodic measurements of orthophosphorus, total phosphorus, ammonia, NO_x , and total nitrogen were used to estimate sediment nutrient release under the evaluated conditions. This information is used to provide an estimate of the significance of mass loadings of nutrients from sediments as part of the overall nutrient budgets for the waterbodies.

5.1.4.1 Field and Laboratory Procedures

Large diameter sediment core samples were collected at 9 locations in Marco Island waterways using 4-inch diameter clear acrylic core tubes. Locations used for collection of the sediment core tubes are indicated on Figure 5-22 and reflect selected locations where the regular sediment core samples were collected as discussed in Section 2.4. In general, the sample locations reflect the major areas of each sub-basin. Each of the acrylic tubes was driven into the sediments to the maximum possible depth using a 20-pound hammer weight. A 4-inch x 4-inch wooden beam was placed on top of the acrylic core tubes to evenly distribute the force of each hammer blow and to prevent direct contact between the hammer weight and the acrylic tube. Large core sites designated as S-3, S-5, and S-22 are located in areas with reuse irrigation, while the remaining sites are located in areas without reuse irrigation.

The acrylic tubes were penetrated into the sediments to depths ranging from approximately 2-4 ft, depending upon the physical characteristics of the sediments at each of the selected monitoring sites or until a firm bottom material was encountered. Each of the core tubes was retrieved intact, along with the overlying water column present at each of the collection sites. Upon retrieval, a rubber cap was attached to the bottom of each core tube using a stainless steel band to prevent loss of sediments and water. A 4-inch PVC cap was then placed on the top of each collected core tube, and the core tubes were transported to the ERD laboratory in a vertical position to avoid mixing of the sediment layers.

After return to the laboratory, the sediment depth in each of the 9 core samples was adjusted to a uniform 24-30 inches by releasing sediment as necessary from the bottom of each core tube. The collected water volume above the sediments was carefully siphoned off and replaced with a 24-inch layer of surface water collected at each site. Each of the acrylic core tubes was then cut to a uniform height of 54 inches, leaving a 6-inch air space between the water level and the top of the column. Three separate 0.25-inch diameter holes were then drilled into the PVC cap attached to the top of each core sample. A 0.25-inch diameter semi-rigid polyethylene tube was inserted through one of the holes to a depth of approximately 2-3 inches above the sediment surface, and an air stone diffuser was attached to the end of the tubing inside each core tube. This system was used to introduce selected gases into the core tubes to create aerobic or anoxic conditions.

A separate piece of polyethylene tubing was inserted into the second hole in the top of each core tube, approximately 1 inch below the level of the cap, but above the water level contained in each tube. The other end of the tubing was connected to a water trap to minimize loss of water from each column as a result of evaporation. This tubing also provided a point of exit for gases which were bubbled into each core tube. The rate of gas addition was monitored by observing the rate of bubbles introduced into the water trap. A third 0.25-inch polyethylene tube was inserted through the top cap of the 4-inch cap and extended to approximately mid-way into the overlying water column for sample collection. The 4-inch core tubes were placed inside a 6-inch Sch. 40 PVC pipe to provide a dark controlled environment for creating either aerobic or anoxic conditions. The 6-inch PVC chambers were attached to a laboratory work bench for support. Schematics of the sediment incubation apparatus are given in Figures 5-23 and 5-24.

After initial set-up of the incubation apparatus, a compressed stream of air was introduced into each of the core tubes through a manifold system with attachments to each of the individual air stone diffusers to create aerobic conditions within the core tubes. At the conclusion of the experimentation under aerobic conditions, the compressed air source was replaced with a compressed argon source. The gas addition was used to ensure that water within each of the core tubes was well mixed without disturbing the sediments, so that the nutrient mass released from the sediments could be quantified as a function of changes in concentrations within the water column of each core tube. On approximately a 1-2 day interval, 20 ml of water was withdrawn from each of the columns through the 0.25-inch polyethylene tube using a plastic laboratory syringe. Each of the collected samples was immediately filtered using a 0.45 micron syringe type membrane filter and analyzed for ammonia, NO_x , total nitrogen, orthophosphorus, and total phosphorus using the analytical methods outlined in Table 2-9.

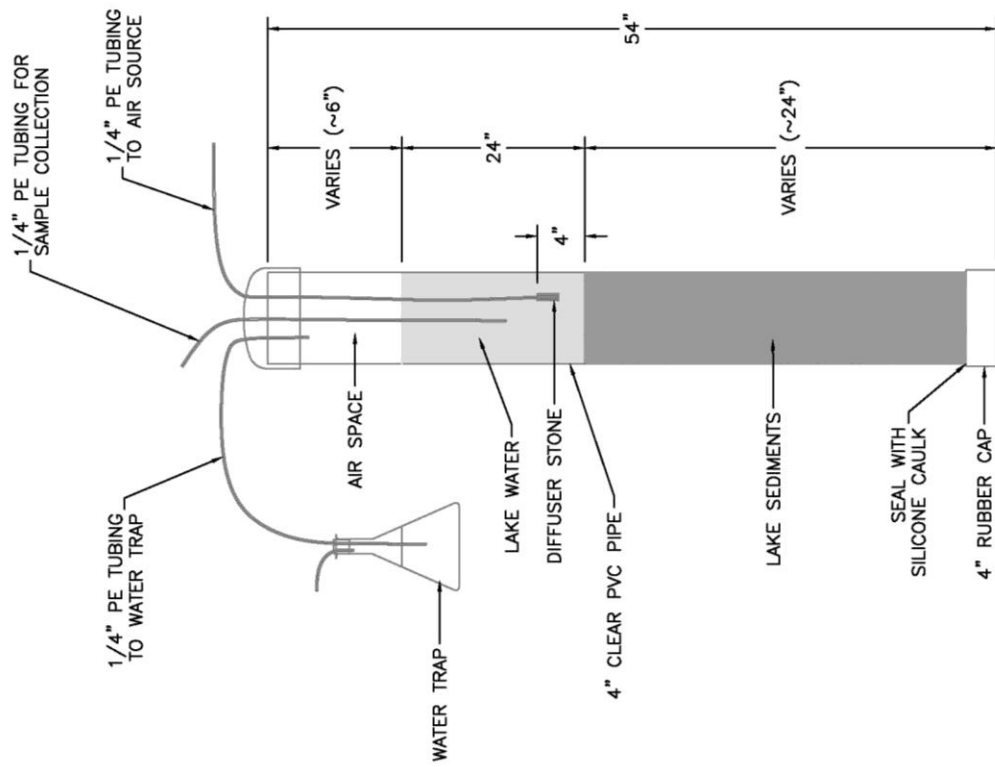

Figure 5-23. Schematic of Sediment Incubation Apparatus.

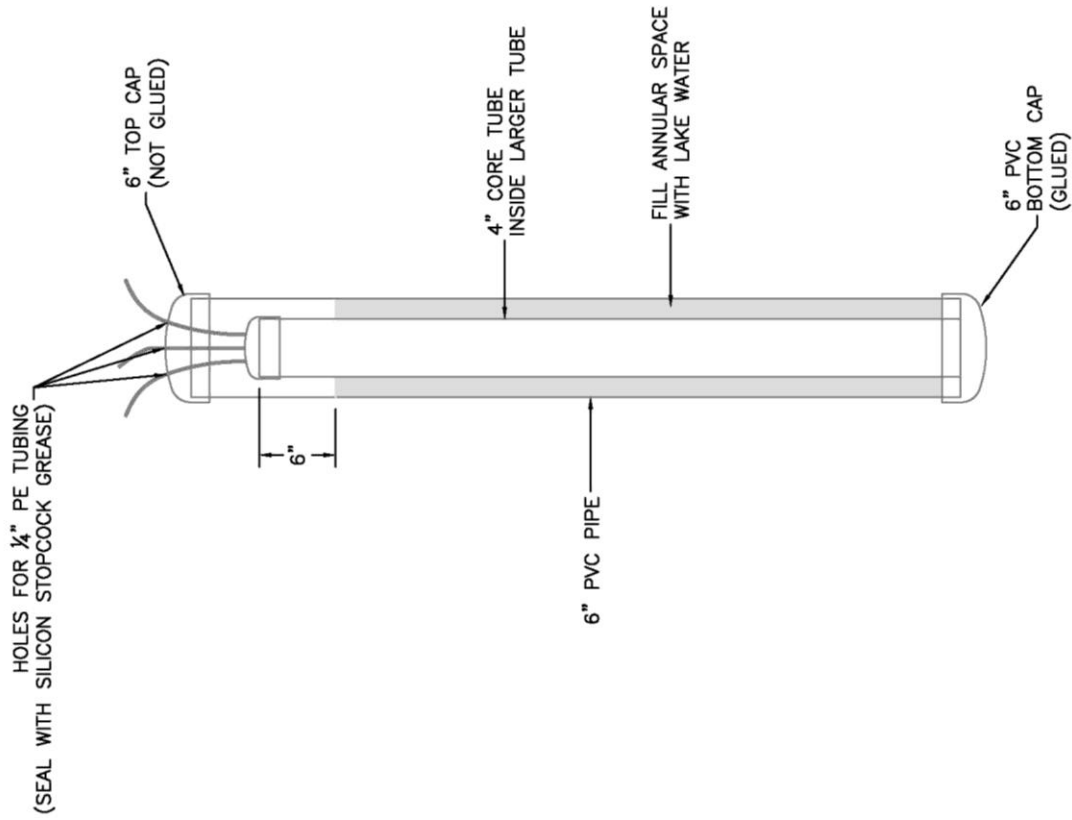

Figure 5-24. Schematic of Sediment Core Incubation System.

After anoxic conditions were established, as verified by an H₂S smell in the outflow from the water trap, the argon gas addition was reduced to 1-2 hours per day, generally in association with a sampling event, to ensure completely mixed conditions within each tube prior to sample collection. This process was continued in each of the core tubes for a period of approximately 30 days. Compressed air was gently bubbled continuously through each of the columns to increase dissolved oxygen and create aerobic conditions within each tube. In general, creation of aerobic conditions, as indicated by measurements of redox potential (> 200 mv) within each of the columns, occurred within approximately 24-36 hours. At the onset of aerobic conditions, sample collection was conducted at a 1-2 day interval from each of the columns using the method previously outlined for aerobic conditions.

Collection of the large diameter (4-inch) sediment core samples was conducted on June 2, 2020 for sites S-3, S-4, S-5, S-9, and S-23, and on July 29 for sites S-10, S-15, S-16, and S-22. Experimentation under aerobic conditions was conducted in each core tube for a period of 40-42 days. Anoxic experimentation was initiated at the end of the aerobic experiments and was continued for a period of 31-42 days.

5.1.4.2 Calculation of Mass Release

A summary of the laboratory results of samples collected during the sediment release experiments is given in Appendix G-1. Changes in concentrations of nitrogen and phosphorus over time are provided for each of the isolation chamber experiments under both aerobic and anoxic conditions. The measured concentrations of total nitrogen, SRP, and total phosphorus from each sampling date (in µg/l) are multiplied by the volume of water in each large core cylinder (liter), corrected for volume losses due to sample collection, to obtain the mass of each measured parameter in the overlying water column at the time of each monitoring event (mass in µg). The measured values reflect **net** sediment release since some of the released nutrients are likely taken up by biological processes in each tube, although this uptake is probably less than 5-10% of the total released nutrients.

The mass release rate in the incubation experiments is defined as the slope of the rising limb of the total nitrogen, SRP, and total phosphorus release plots presented in Appendix G-2. The mass of nitrogen and phosphorus is plotted as a function of time to evaluate the rate of change in mass over time, and the best-fit regression line through the points is used to calculate the release rate in terms of µg/day. In some chambers, an initial delay in nutrient release occurred as anoxic or aerobic conditions were established within each chamber. In these cases, the release rate is calculated using the data obtained between the start of the upward release trend and the maximum nutrient concentrations measured within a sample. In some experiments, nutrient concentrations began to decrease after reaching the maximum concentration, presumably due to biological uptake within the chamber, and these data are also excluded from estimation of the release rate. Regression relationships developed for estimation of sediment nutrient release rates in the incubation experiments under aerobic and anoxic conditions are included in Appendix G-2.

A summary of calculated sediment nutrient release rates in Marco Island core samples during the isolation chamber experiments is given in Table 5-13. Release rates are provided for total nitrogen, SRP, and total phosphorus at each of the 9 isolation chamber core samples under both aerobic and anoxic conditions. The release rates reflect the slope of the release rate plots for total nitrogen, SRP, and total phosphorus provided in Appendix G-2. The calculated release rates are converted into a mass release per day by dividing by the surface area of the 4-inch diameter incubation chambers resulting in an areal mass release in terms of mg/m²-day.

TABLE 5-13

**MEASURED EXPERIMENTAL SEDIMENT
RELEASE RATES AT MARCO ISLAND**

| CONDITION | SITE | MASS RELEASE (mg/day) | | | MASS RELEASE (mg/m ² -day) | | |
|-----------|--------------|--------------------------|--------------|--------------|--|-------------|-------------|
| | | SRP | Total P | Total N | SRP | Total P | Total N |
| Aerobic | S-3 | 35.7 | 35.7 | 107 | 4.46 | 4.46 | 13.4 |
| | S-4 | 20.2 | 22.4 | 226 | 2.53 | 2.80 | 28.3 |
| | S-5 | 29.8 | 29.8 | 157 | 3.73 | 3.73 | 19.6 |
| | S-9 | 41.8 | 43.7 | 168 | 5.23 | 5.46 | 21.0 |
| | S-10 | 12.8 | 17.1 | 418 | 1.60 | 2.14 | 52.3 |
| | S-15 | 7.55 | 8.46 | 268 | 0.94 | 1.06 | 33.5 |
| | S-16 | 10.2 | 11.3 | 90.6 | 1.28 | 1.41 | 11.3 |
| | S-22 | 16.4 | 18.1 | 175 | 2.05 | 2.26 | 21.9 |
| | S-23 | 70.6 | 71.8 | 214 | 8.83 | 8.98 | 26.8 |
| | MEAN: | 23.51 | 25.35 | 233.1 | 2.94 | 3.17 | 29.1 |
| Anoxic | S-3 | 70.7 | 70.8 | 193 | 8.84 | 8.85 | 24.1 |
| | S-4 | 44.6 | 46.0 | 141 | 5.58 | 5.75 | 17.6 |
| | S-5 | 25.3 | 26.0 | 90.5 | 3.16 | 3.25 | 11.3 |
| | S-9 | 47.9 | 44.4 | 47.4 | 5.99 | 5.55 | 5.9 |
| | S-10 | 14.8 | 16.3 | 247 | 1.85 | 2.04 | 30.9 |
| | S-15 | 101 | 103 | 404 | 12.63 | 12.88 | 50.5 |
| | S-16 | 37.7 | 55.9 | 135 | 4.71 | 6.99 | 16.9 |
| | S-22 | 55.0 | 60.5 | 241 | 6.88 | 7.56 | 30.1 |
| | S-23 | 155 | 156 | 328 | 19.38 | 19.50 | 41.0 |
| | MEAN: | 61.33 | 64.32 | 203.0 | 7.67 | 8.04 | 25.4 |

A summary of measured experimental sediment release rates at the Marco Island large core sites by sub-basin is given in Table 5-14. This table provides mean release rates for each sub-basin area under aerobic and anoxic conditions based upon the sediment core samples included in each sub-basin area. Under aerobic conditions, mass release rates for SRP in the 5 sub-basins ranged from 0.94-4.43 mg/m²-day, with total phosphorus release rates ranging from 1.06-4.49 mg/m²-day, and total nitrogen release rates ranging from 15.7-52.3 mg/m²-day. The highest aerobic release rates for phosphorus were observed in Sub-basins 1 and 2, with somewhat lower values observed in the remaining sub-basins. For total nitrogen, the largest aerobic sediment release rate was observed in Sub-basin 3, with substantially lower values in the remaining sub-basins.

TABLE 5-14

**MEASURED EXPERIMENTAL SEDIMENT RELEASE
RATES AT MARCO ISLAND BY SUB-BASIN**

| CONDITION | SUB-BASIN | SITES INCLUDED | MASS RELEASE (mg/m ² -day) | | | |
|-----------|-------------------------|----------------|---------------------------------------|-------------|-------------|-------------|
| | | | SRP | Total P | Total N | |
| Aerobic | 1 | S-3, S-5, S-8 | 4.43 | 4.49 | 17.7 | |
| | 2 | S-4 | 2.53 | 2.80 | 28.3 | |
| | 3 | S-10 | 1.60 | 2.14 | 52.3 | |
| | 4 | S-16, S-22 | 1.62 | 1.79 | 15.7 | |
| | 5 | S-15 | 0.94 | 1.06 | 33.5 | |
| | MEAN: | | | 2.22 | 2.46 | 29.5 |
| | BACKGROUND SITE: | S-23 | 8.83 | 8.98 | 26.8 | |
| Anoxic | 1 | S-3, S-5, S-8 | 5.51 | 5.42 | 11.7 | |
| | 2 | S-4 | 5.58 | 5.75 | 17.6 | |
| | 3 | S-10 | 1.85 | 2.04 | 30.9 | |
| | 4 | S-16, S-22 | 5.69 | 7.27 | 22.5 | |
| | 5 | S-15 | 12.63 | 12.88 | 50.5 | |
| | MEAN: | | | 6.25 | 6.67 | 26.7 |
| | BACKGROUND SITE: | S-23 | 19.38 | 19.5 | 41.0 | |

Under anoxic conditions, sediment release rates for total phosphorus increased substantially at most sites, particularly in Sub-basin 5 where anoxic release rates were approximately 10 times greater than aerobic release rates. In contrast, sediment release rates for total nitrogen under anoxic conditions were lower in value in most sub-basins than observed under aerobic conditions.

It is interesting to note that the sediment release rates for total phosphorus at the background monitoring site (S-23) are substantially higher in value for both SRP and total phosphorus than values measured within the waterway areas. Although this site was intended to reflect background conditions, the data suggest that the Marco Bay area may serve as a depositional area for nutrient loadings discharging from the waterways, eastern creeks, and channels rather than providing a truly undisturbed background site. In contrast, sediment release rates for total nitrogen appeared to be more similar between sub-basin and background monitoring sites, although a slightly higher total nitrogen release was observed at the background site under anoxic conditions.

The observed nutrient release rates in Marco Island waterways reflect a combination of release rates occurring under aerobic and anoxic conditions. Based on the field monitoring program conducted by ERD from April-September 2020, the Marco Island waterways maintained aerobic conditions throughout the water column during virtually all monitoring events to a depth of 5-6 m. In areas where the waterbody depth exceeded 6 m, anoxic conditions were routinely observed in lower portions of the water column. However, these deeper areas are relatively rare within the waterways, and for purposes of this analysis, sediments are assumed to maintain aerobic conditions approximately 90% of the time, with anoxic conditions occurring during the remaining 10% of the time. These ratios are used to calculate weighted release rates using the measured releases under aerobic and anoxic conditions.

A summary of calculated annual sediment release of total nitrogen and total phosphorus in Marco Island waterways is given in Table 5-15. This analysis assumes aerobic release rates occurred during 90% of the time, with anoxic release rates occurring during the remaining 10% of the time. Weighted release rates are calculated using this assumed distribution of aerobic and anoxic events for each sub-basin area. The weighted release rates are multiplied by the area of each waterbody to obtain estimates of overall mass release of phosphorus and nitrogen from sediments into the overlying water column on an annual basis.

Annual loadings of total phosphorus from sediment nutrient release ranged from 351 kg/yr in Sub-basin 2 to 3,884 kg/yr in Sub-basin 1, with an overall total of 7,125 kg/yr of total phosphorus generated through sediment release. Measured nitrogen release from sediments ranges from 3,080 kg/yr in Sub-basin 2 to 16,876 kg/yr in Sub-basin 3. Overall, sediment nutrient release contributes approximately 57,958 kg/yr of total nitrogen to Marco Island waterways. The information summarized in this table is used in a subsequent section to generate annual nutrient budgets for each sub-basin area.

TABLE 5-15

**CALCULATED ANNUAL SEDIMENT RELEASE OF TOTAL NITROGEN
AND TOTAL PHOSPHORUS IN MARCO ISLAND WATERWAYS**

| SUB-BASIN | FREQUENCY OF CONDITION (%) | | WEIGHTED MASS RELEASE (mg/m ² -day) | | | ASSUMED AREA (acres) | MASS RELEASE (kg/yr) | | |
|------------------------|----------------------------|--------|--|-------------|-------------|----------------------|----------------------|--------------|---------------|
| | Aerobic | Anoxic | SRP | Total P | Total N | | SRP | Total P | Total N |
| 1 | 90 | 10 | 4.54 | 4.59 | 17.1 | 565.5 | 3,792 | 3,834 | 14,268 |
| 2 | 90 | 10 | 2.83 | 3.10 | 27.2 | 76.7 | 321 | 351 | 3,080 |
| 3 | 90 | 10 | 1.63 | 2.13 | 50.1 | 227.9 | 547 | 716 | 16,876 |
| 4 | 90 | 10 | 2.02 | 2.34 | 16.4 | 374.3 | 1,120 | 1,292 | 9,083 |
| 5 | 90 | 10 | 2.11 | 2.24 | 35.2 | 281.7 | 879 | 932 | 14,652 |
| GEOMETRIC MEAN: | | | 2.46 | 2.75 | 26.7 | -- | -- | -- | -- |
| TOTAL: | | | | | | 1,526.1 | 6,659 | 7,125 | 57,959 |

5.2 Annual Nutrient Budgets

Mean annual mass budgets were developed for total nitrogen and total phosphorus for each of the 5 Marco Island waterways based upon the analyses presented in previous sections. A discussion of annual mass loadings of total nitrogen and total phosphorus is given in the following sections.

5.2.1 Nitrogen Loadings

A tabular summary of calculated mean annual mass loadings of total nitrogen to Marco Island waterways is given in Table 5-16. Estimated annual mass loadings are provided for precipitation, runoff, groundwater seepage, and sediment internal recycling.

The most significant annual mass loadings of total nitrogen to Marco Island waterbodies originates from sediment nutrient release which contributes 60.5-77.4% of the annual nitrogen loadings, depending upon sub-basin. The second most significant nitrogen loading to Marco Island waterbodies is groundwater seepage which contributes 14.6-30.1% of the estimated annual loadings. Combined together, sediment nutrient release and groundwater seepage contribute approximately 90% or more of the annual nitrogen loads for most sub-basins.

Annual mass loadings of total nitrogen from stormwater runoff to Marco Island waterbodies are low in comparison to other sources, contributing only 2.8-8.7% of the annual nitrogen inputs. The smallest annual contribution of total nitrogen originates from bulk precipitation which contributes 1.4-3.6% of the annual nitrogen loadings, depending upon the particular sub-basin. A graphical comparison of nitrogen sources for each of the 5 sub-basin areas is given on Figure 5-25.

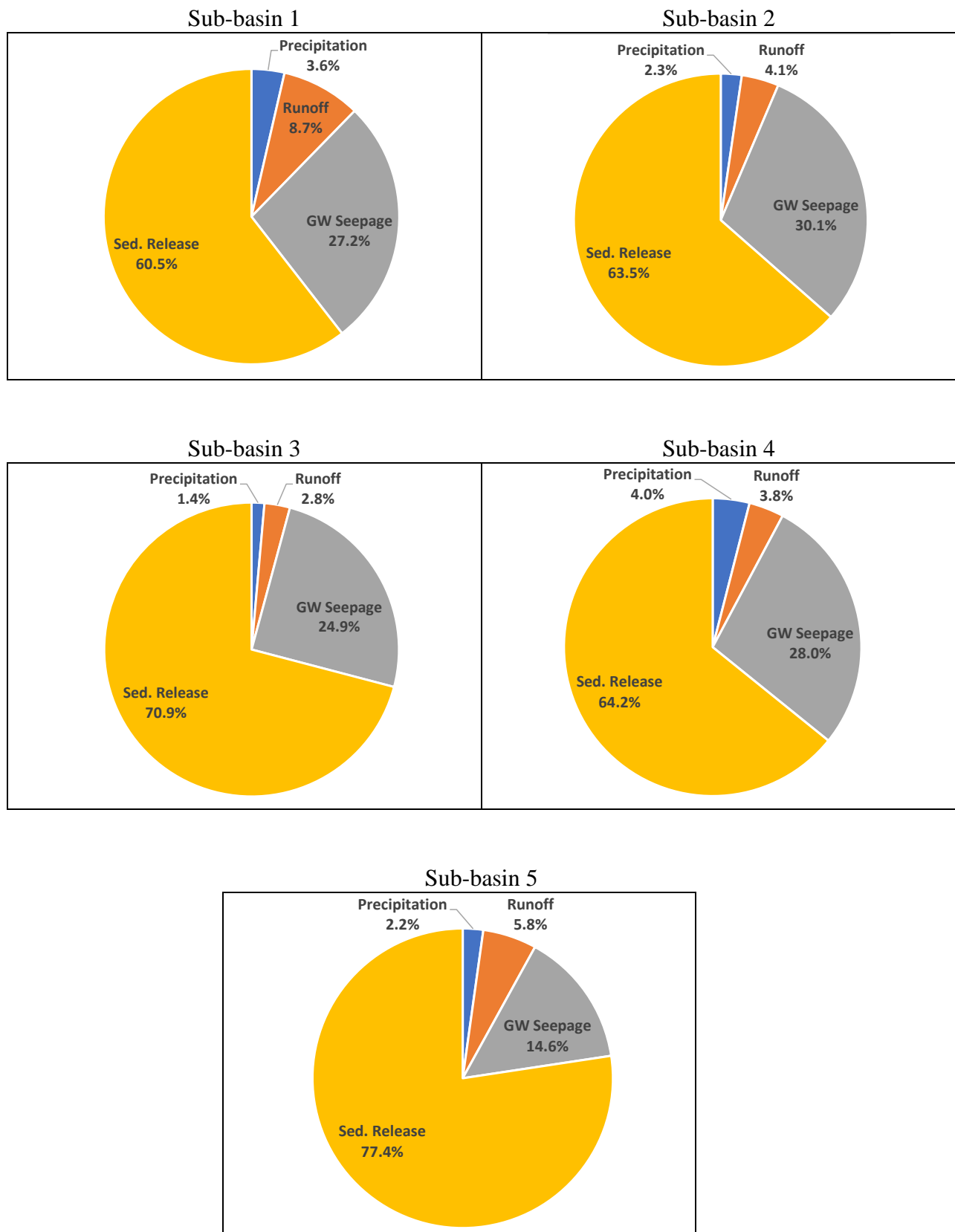

Figure 5-25. Graphical Comparison of Nitrogen Sources for the Five Marco Island Sub-basin Waterways.

TABLE 5-16
ESTIMATED ANNUAL MASS LOADINGS OF
TOTAL NITROGEN TO MARCO ISLAND WATERBODIES

| INPUT SOURCE | SUB-BASIN 1 | | SUB-BASIN 2 | | SUB-BASIN 3 | | SUB-BASIN 4 | | SUB-BASIN 5 | |
|---------------------------------------|------------------------|----------------------|------------------------|----------------------|------------------------|----------------------|------------------------|----------------------|------------------------|----------------------|
| | Annual Loading (kg/yr) | Percent of Total (%) | Annual Loading (kg/yr) | Percent of Total (%) | Annual Loading (kg/yr) | Percent of Total (%) | Annual Loading (kg/yr) | Percent of Total (%) | Annual Loading (kg/yr) | Percent of Total (%) |
| Precipitation | 845 | 3.6 | 113 | 2.3 | 340 | 1.4 | 559 | 4.0 | 421 | 2.2 |
| Runoff | 2,043 | 8.7 | 197 | 4.1 | 669 | 2.8 | 543 | 3.8 | 1,103 | 5.8 |
| Groundwater Seepage | 6,418 | 27.2 | 1,460 | 30.1 | 5,905 | 24.9 | 3,959 | 28.0 | 2,764 | 14.6 |
| Sediment Release | 14,268 | 60.5 | 3,080 | 63.5 | 16,876 | 70.9 | 9,083 | 64.2 | 14,652 | 77.4 |
| TOTAL: | 23,574 | 100.0 | 4,850 | 100.0 | 23,790 | 100.0 | 14,144 | 100.0 | 18,940 | 100.0 |
| Waterway Area (acres): | 565.5 | | 76.7 | | 227.9 | | 374.3 | | 281.7 | |
| Areal Loading (g/m ² -yr): | 10.3 | | 15.6 | | 25.8 | | 9.3 | | 16.6 | |

A comparison of annual areal loadings of nitrogen to Marco Island waterbodies associated with each of the 5 sub-basin areas is provided at the bottom of Table 5-16. This evaluation allows a comparison of relative loadings between the individual sub-basin areas based upon the area of the receiving waterbody. Areal nitrogen loadings to the 5 waterbodies range from 9.3-25.8 g N/m²-yr. Typical areal nitrogen loading rates to relatively undisturbed marine systems are substantially less than 10 g N/m²-yr. Based upon this guideline, Marco Island waterbodies receive annual nitrogen inputs which are somewhat higher than relatively undisturbed marine systems. A further analysis of areal loadings is given in Section 5.2.3.

5.2.2 Phosphorus Loadings

A tabular summary of calculated mean annual phosphorus loadings to Marco Island waterbodies is given in Table 5-17. Estimated annual mass loadings are provided for the same input sources previously discussed for total nitrogen.

On an average annual basis, the most significant loadings of total phosphorus to Marco Island waterbodies originates from sediment nutrient release which contributes 41.8-71.9% of the annual phosphorus loadings, depending upon sub-basin area. Groundwater seepage is the second most significant loading source for phosphorus in Sub-basins 1, 2, 3, and 4, contributing 17.9-41.8% of the annual phosphorus loading to adjacent waterbodies. However, for Sub-basin 5 waterways, stormwater runoff is the second most significant loading source, contributing 23.7% of the annual phosphorus loading to this waterway.

TABLE 5-17
ESTIMATED ANNUAL MASS LOADINGS OF
TOTAL PHOSPHORUS TO MARCO ISLAND WATERBODIES

| INPUT SOURCE | SUB-BASIN 1 | | SUB-BASIN 2 | | SUB-BASIN 3 | | SUB-BASIN 4 | | SUB-BASIN 5 | |
|---------------------------------------|------------------------|----------------------|------------------------|----------------------|------------------------|----------------------|------------------------|----------------------|------------------------|----------------------|
| | Annual Loading (kg/yr) | Percent of Total (%) | Annual Loading (kg/yr) | Percent of Total (%) | Annual Loading (kg/yr) | Percent of Total (%) | Annual Loading (kg/yr) | Percent of Total (%) | Annual Loading (kg/yr) | Percent of Total (%) |
| Precipitation | 133 | 2.5 | 18 | 2.4 | 53 | 3.1 | 88 | 3.9 | 66 | 3.7 |
| Runoff | 411 | 7.7 | 65 | 8.9 | 227 | 13.3 | 157 | 6.9 | 422 | 23.7 |
| Groundwater Seepage | 957 | 17.9 | 297 | 40.7 | 716 | 41.8 | 741 | 32.5 | 363 | 20.4 |
| Sediment Release | 3,834 | 71.9 | 351 | 48.0 | 716 | 41.8 | 1,292 | 56.7 | 932 | 52.2 |
| TOTAL: | 5,335 | 100.0 | 731 | 100.0 | 1,712 | 100.0 | 2,278 | 100.0 | 1,783 | 100.0 |
| Waterway Area (acres): | 565.5 | | 76.7 | | 227.9 | | 374.3 | | 281.7 | |
| Areal Loading (g/m ² -yr): | 2.3 | | 2.4 | | 1.9 | | 1.5 | | 1.6 | |

Stormwater runoff is the third most significant phosphorus source to Sub-basins 1, 2, 3, and 4, contributing 6.9-23.7% of the annual phosphorus loadings. Groundwater seepage is the third most significant phosphorus loading to Sub-basin 5. Phosphorus loadings to Marco Island waterbodies from bulk precipitation are relatively minimal, contributing only 2.4-3.8% of the annual average phosphorus inputs. A graphical comparison of phosphorus inputs to each of the 5 waterbodies is given on Figure 5-26.

A comparison of average annual areal loadings of phosphorus to Marco Island waterbodies is given in the final row of Table 5-17. Areal loading rates for phosphorus range from 1.5-2.4 g P/m²-yr. Typical areal phosphorus loading rates to a relatively undisturbed marine system ranges from 1-2 g P/m²-yr, with waterways for Sub-basins 3, 4, and 5 in this range and somewhat higher loading rates in Sub-basins 1 and 2.

5.2.3 Comparison with Other Marine Systems

A summary of annual areal nitrogen loading rates for selected marine and estuarine systems is given in Table 5-18 (Bovnton et al., 1995) as a comparison with areal nitrogen loading rates measured at Marco Island and summarized in Table 5-16. Areal nitrogen loading rates for the waterways associated with the 5 sub-basins range from 9.3-25.8 g TN/m²-yr. Areal nitrogen loading rates for Sub-basins 1 and 4 range from 9.3-10.3 g N/m²-yr which is similar to values in the North Sea and Pamlico River in North Carolina. Sub-basins 2 and 5 have nitrogen loading rates ranging from 15.6-16.6 g N/m²-yr which is similar to Mobile Bay in Alabama. The highest areal loading rate of 25.8 g N/m²-yr was measured in Sub-basin 3 which is similar to San Francisco Bay and Narragansett Bay in Rhode Island.

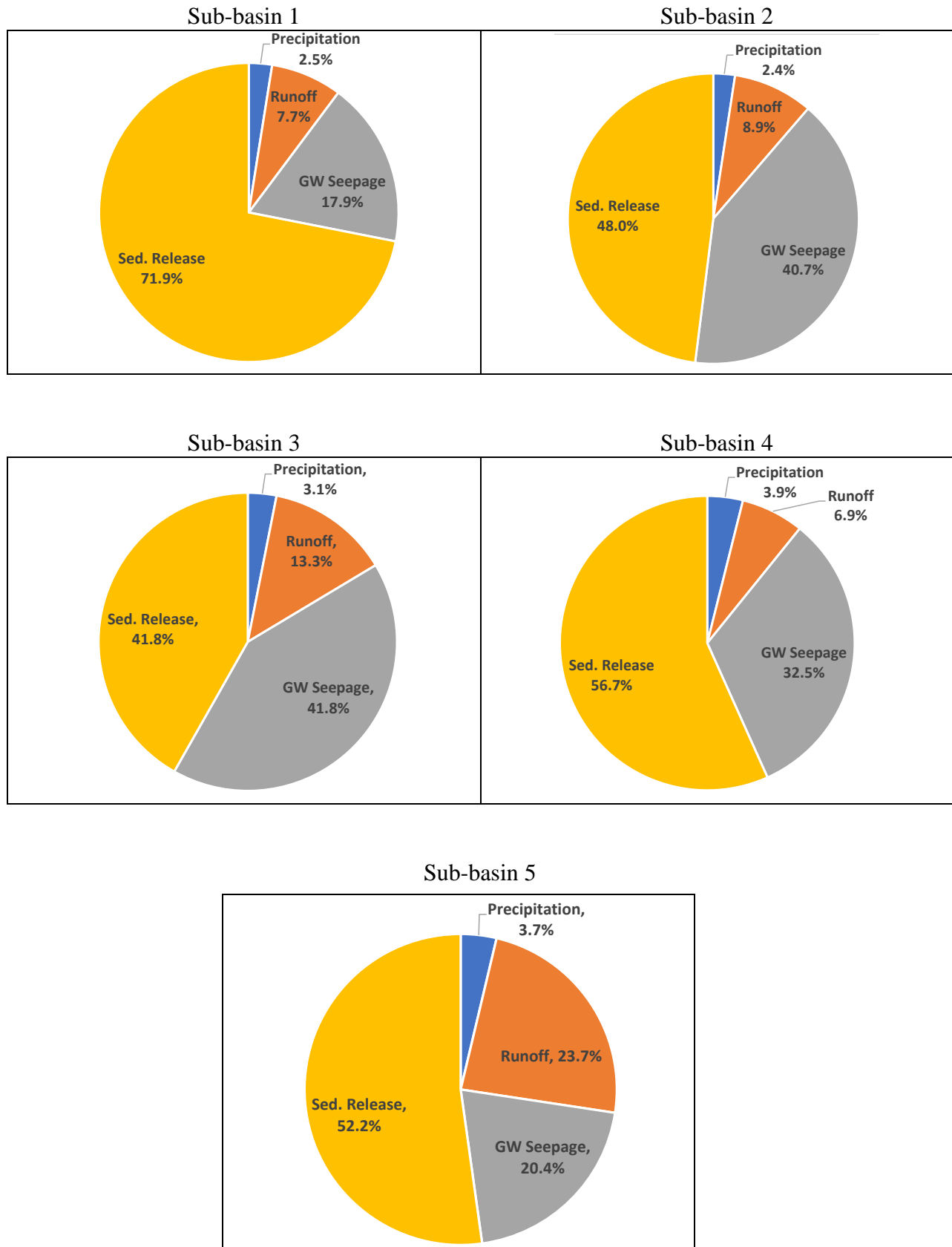

Figure 5-26. Graphical Comparison of Phosphorus Sources for the Five Marco Island Sub-basin Waterways.

TABLE 5-18

**SUMMARY OF ANNUAL AREAL TOTAL NITROGEN
LOADING RATES FOR ESTUARINE AND COASTAL SYSTEMS**

| LOCATION | TOTAL NITROGEN LOADING RATE (g N/m²-yr) |
|--------------------------------------|---|
| Kaneohe Bay (Hawaii) | 2.2 |
| Maryland Coastal Bays (lower bays) | 2.4-3.1 |
| Baltic Sea (Sweden) | 3.0 |
| Choptank River (Maryland) | 4.3 |
| Maryland Coastal Bays (upper bays) | 4.1-6.5 |
| Albermarle Sound (North Carolina) | 7.1 |
| Apalachicola Bay (Florida) | 7.8 |
| North Sea | 9.4 |
| Pamlico River (North Carolina) | 12.0 |
| Patuxent River (Maryland) | 12.7 |
| Mobile Bay (Alabama) | 17.9 |
| Delaware Bay (Delaware) | 18.2 |
| Mainstem Chesapeake Bay (Maryland) | 20.5 |
| South San Francisco Bay (California) | 22.6 |
| Narragansett Bay (Rhode Island) | 27.6 |
| Maryland Coastal Bays (tributaries) | 15.7-39.7 |
| Potomac River (Maryland) | 29.3 |
| Patapsco River (Maryland) | 49.0 |
| Tokyo Bay (Japan) | 89.1 |

Source: Bovnton, et al. (1995)

SECTION 6

ISOTOPE ANALYSIS OF INPUTS TO MARCO ISLAND WATERWAYS

6.1 Introduction

Isotopes are atoms of an element that differ in mass due to differing numbers of neutrons in the atoms' nucleus. Some isotopes are unstable and are referred to as radioisotopes. Other isotopes have no known decay constants and are referred to as stable isotopes. Isotopes of the same element have the same numbers of protons and electrons, thereby having similar chemical properties and similar chemical reactions. However, because of the difference in bond strength due to differing numbers of neutrons, different stable isotopes react at slightly different rates. In general, molecules containing heavier isotopes react more slowly. Differences in reaction rates give rise to "fractionation", such that isotopes are distributed unevenly in natural systems. Biological systems often exhibit strong fractionation effects, such that molecules containing the light isotope of an element react more quickly with a biological enzyme than do molecules containing the heavier isotope. Thus, molecules from different sources in the environment often exhibit isotopic "fingerprints" which can be useful in source partitioning studies.

There are two stable isotopes of nitrogen, ^{14}N and ^{15}N , where the superscripts describe the atomic mass of the isotope. ^{14}N contains seven protons and neutrons, whereas ^{15}N contains seven protons but eight neutrons. ^{14}N is the more abundant isotope of nitrogen since most nitrogen reservoirs in nature (e.g., the atmosphere) contain approximately 99.6% ^{14}N and only 0.4% ^{15}N . Fractionation processes cause very slight variations in this composition, differences that can be detected using isotope-ratio mass spectroscopy, routinely distinguishing samples that differ by as little as 0.0001 atom percent ^{15}N .

Nitrate (NO_3^-) in surface waters can originate from multiple sources, including fertilizer application, animal waste, septic systems, and soil and natural deposition. Stable isotope analysis can help distinguish which of the sources is more likely to contribute to contamination in a given site because these multiple sources often differ in isotope composition. Organisms preferentially use the light isotope (^{14}N) over the heavy isotope (^{15}N) so that mass created by organisms is isotopically lighter than mass created by other processes.

A summary of nitrogen sources and typical isotope signatures is given in Table 6-1. For example, high $\delta^{15}\text{N}$ values can be traced to animal waste and sewage inputs (e.g., Wassenaar, 1995; Kendall, 1998; Kendall, et al. 1996), since biological processes preferentially use the lighter ^{14}N leading to enrichment of ^{15}N . Atmospheric N deposition as NO_3^- or NH_4^+ , N derived from synthetic fertilizers, and soil-derived N typically differ in $\delta^{15}\text{N}$ and $\delta^{18}\text{O}$. Stable isotopes of oxygen are also useful in source partitioning, in some cases increasing resolution when combined with $\delta^{15}\text{N}$. Atmospherically derived NO_3^- is enriched in $\delta^{18}\text{O}$ compared to synthetic fertilizer, and both tend to be enriched compared to NO_3^- produced in soils through microbial nitrification.

TABLE 6-1
TYPICAL VALUES AND RANGES FOR $\delta^{15}\text{N}$ AND
 $\delta^{18}\text{O}$ FROM VARIOUS SOURCES OF NITROGEN LOADING
(10-90% Confidence Limits)

| SOURCE | SPECIES | $\delta^{15}\text{N}$ ‰ | $\delta^{18}\text{O}$ ‰ |
|---------------|----------|-------------------------|-------------------------|
| Fertilizer | Ammonium | -1.0 (-5.6 to 4.8) | --- |
| | Nitrate | 1.0 (-4.4 to 6.1) | 22.1 (15.5 to 25.6) |
| Precipitation | Ammonium | -1.6 (-13.4 to 12.8) | --- |
| | Nitrate | 0.2 (-7.8 to 8.7) | 57.9 (25.6 to 77.2) |
| Manure | Ammonium | 10.5 (5.3 to 25.3) | --- |
| Sewage | Ammonium | 10.0 (4.3 to 19.6) | --- |
| Nitrification | Nitrate | 3.5 (-4.1 to 7.9) | 7.4 (0.4 to 15.1)** |
| Soils | Bulk | 4.0 (-2.0 to 8.0)* | --- |

*Unpublished data of Hungate et al. from Florida spodosols shows typical values of -6 to -2 for soil organic nitrogen in the region. Negative $\delta^{15}\text{N}$ values are typical of surface horizons with low clay content.

** For the region in question, the $\delta^{18}\text{O}$ of precipitation is -2 to -6 ‰ vs SMOW (GNIP, www-naweb.iaea.org/napc/ih/GNIP/). In nitrification, two atoms of oxygen are derived from local water, and one from atmospheric O_2 (22.5 ‰), allowing theoretical prediction of the $\delta^{18}\text{O}$ of nitrate derived from nitrification, after allowing for 5 per mil enrichment of local water due to evaporative enrichment (Mayer et al. 2001). Therefore, the expected $\delta^{18}\text{O}$ of nitrate produced by nitrification is 3.8 to 11.5 ‰. Values within this range are consistent with *in situ* microbial origin.

In the Marco Island study, samples of bulk precipitation, stormwater runoff, reuse irrigation, reuse pond, and groundwater seepage were analyzed for $\delta^{15}\text{N}\text{-NO}_3^-$ and $\delta^{18}\text{O}\text{-NO}_3^-$ in addition to NO_x . It is preferred that samples submitted for isotopic analysis typically have measured NO_x concentrations of 100 $\mu\text{g/l}$ or more to enhance the accuracy of the analysis, although many of the collected Marco Island samples had NO_3^- concentrations less than this value. Two general questions were addressed with these data: (1) Are there changes in NO_3^- , $\delta^{15}\text{N}$, and $\delta^{18}\text{O}$ signatures within Marco Island samples that are consistent with internal microbial processing, and if so, is it possible to constrain the $\delta^{15}\text{N}$ and $\delta^{18}\text{O}$ signature of NO_3^- within the system?; and (2) What sources of nitrogen loading are consistent with the observed $\delta^{15}\text{N}$ and $\delta^{18}\text{O}$ signatures of NO_3^- in Marco Island samples.

ERD has previously used stable isotopes on multiple projects to identify sources of nutrients from groundwater seepage and runoff in urban areas and golf courses receiving reclaimed water for irrigation. The isotopic signature of nitrogen derived from golf courses and fertilizers is often unique, but $\delta^{15}\text{N}$ can only be used as a tracer if large verifiable differences in $\delta^{15}\text{N}$ exist between the potential nitrogen sources. For example, the fertilizer applied to golf courses is commonly derived from atmospheric nitrogen, and this causes golf course runoff to contain nitrate with $\delta^{15}\text{N}$ values similar to those of atmospheric N_2 (0-3‰). However, golf course areas which irrigate with reclaimed water derived from sewage often exhibit a sewage signal (i.e., 12-20‰).

6.2 Theory of Measurement

Stable isotopes of carbon, nitrogen, sulfur, oxygen, and hydrogen, which are the most commonly used isotopes in ecological and environmental research, are measured by gas isotope-ratio mass spectrometry. The sample is converted into a gas, such as N_2O , CO_2 , N_2 , SO_2 , or H_2 , and the gas molecules are ionized in the Ion Source (Figure 6-1) which strips an electron from each of them, causing each molecule to be positively charged. The charged molecules then enter a flight tube. The flight tube is bent, and a magnet is positioned over it such that the charged molecules separate according to their mass, with molecules containing the heavier isotope bending less than those containing the lighter isotope.

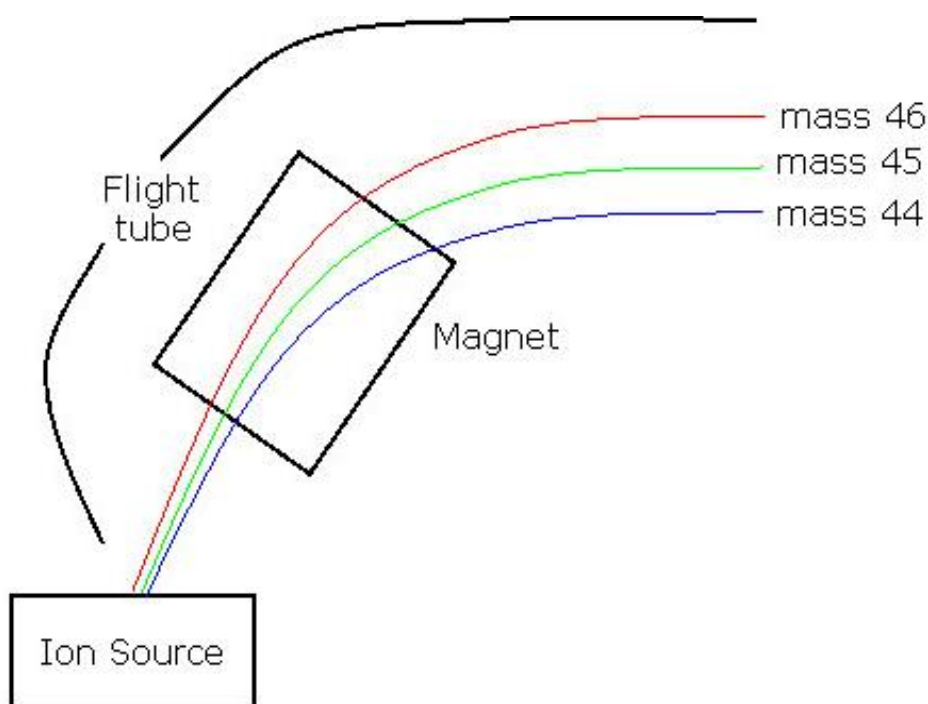

Figure 6-1. Separation of Isotopes by Gas Isotope-Ratio Mass Spectrometry.

Faraday collectors are present at the end of the flight tube to measure the intensity of each beam of ions of a given mass after they have been separated by the magnet. For N_2O , three faraday collectors are set to collect ion beams of masses 44, 45, and 46. Several masses are collected simultaneously, so that the ratios of these masses can be determined very precisely.

In the flight tube, the magnet causes the ions to be deflected, with a radius of deflection that is proportional to the mass-to-charge ratio of the ion. Heavier ions are deflected less than lighter ions. For example, N₂O, mass 46 has the largest radius of deflection, mass 44 has the smallest, and mass 45 is intermediate. Charge also affects the radius of deflection but, for the most part, this is held constant because the ion source strips only one electron from most molecules.

Stable isotope abundances are expressed as the ratio of the two most abundant isotopes in the sample compared to the same ratio in an international standard, using the “delta” (δ) notation. Because the differences in ratios between the sample and standard are very small, they are expressed as parts per thousand or “per mil” (‰) deviation from the standard:

$$\delta X \text{ sample} = \left\{ \left(\frac{{}^H X / {}^L X \text{ sample}}{({}^H X / {}^L X \text{ standard})} \right) - 1 \right\} \times 100$$

Where “^HX and ^LX” are the heavy and light stable isotopes of element X, “sample” refers to the environmental sample being analyzed, and “standard” refers to the international standard for element X. This equation defines the delta value of the standard as 0‰. For carbon, the international standard is Pee Dee Belemnite, a carbonate formation, with a generally accepted absolute ratio of ¹³C/¹²C equal to 0.0112372. Materials with ratios of ¹³C/¹²C greater than 0.0112372 have positive delta values, and those with ratios less than 0.0112372 have negative delta values.

Stable isotope techniques rely on natural differences in the ways that “heavy” and “light” isotopes are processed in the environment through chemical, biological, and physical transformations. These are referred to as “natural abundance isotope techniques”. Stable nitrogen isotopes of dissolved nutrients also provide specific information about the origin of nutrients. Pastureland, residential communities, and golf courses all produce nitrogen with unique isotopic signatures (Kendall, 1998). Land that is covered with a significant amount of cattle often produce nitrate with very heavy $\delta^{15}\text{N}$ values. This isotopic signature is due to the large amount of ¹⁴NH₃ released during ammonia volatilization of animal wastes which leaves the remaining material enriched in the heavier nitrogen isotope, ¹⁵N.

Nitrogen derived from treated sewage undergoes similar biogeochemical processing through denitrification, which is the heterotrophic breakdown of organic matter. Denitrification produces N₂ with a high concentration of ¹⁴N, leaving the remaining bulk waste material concentrated in ¹⁵N. Consequently, nitrate that originates from pastureland and sewage have similar $\delta^{15}\text{N}$ values (12- 20‰). Contrastingly, nitrate derived from residential soils often has an intermediate nitrogen isotopic range (3-8‰). Possible contributions to the residential signal may include nitrogen derived from septic tanks, fertilizer application, or soil redistribution and relocation. Residential land development may also transport the ¹⁵N-enriched organic matter that normally occurs in deeper soil layers to the surface.

6.3 Analyses

Collected samples of bulk precipitation, stormwater runoff, reuse, reuse pond, and groundwater seepage from Marco Island were filtered using a 0.2 micron filter, frozen to halt microbial processes, and shipped to the Stable Isotope Facility (SIF), based at the University of California-Davis (UC Davis) for isotope analyses. This laboratory is designed to serve students, researchers, and faculty at UC Davis who require stable isotope analyses for their research, although analyses are also conducted for researchers outside the university. All isotope analyses were overseen by Kate Ewert with SIF. Information concerning sample collection, preservation, and shipping were provided to ERD by SIF.

A summary of isotope analyses conducted on Marco Island samples is given in Table 6-2. Overall, a total of 235 separate samples was submitted to SIF for analysis.

TABLE 6-2
SUMMARY OF ISOTOPE ANALYSES
CONDUCTED ON MARCO ISLAND SAMPLES

| SAMPLE TYPE | NUMBER OF SAMPLES SUBMITTED FOR ISOTOPE ANALYSES |
|---------------------|---|
| Bulk Precipitation | 23 |
| Runoff | 97 |
| Reuse Irrigation | 27 |
| Reuse Pond | 14 |
| Groundwater Seepage | 74 |
| TOTAL: | 235 |

Samples selected for isotopic analyses were measured for NO_3^- concentrations in the ERD Laboratory, and the data were provided to SIF to determine appropriate volumes for isotope analyses. The denitrifier method was used by SIF to measure the $\delta^{15}\text{N}$ and $\delta^{18}\text{O}$ composition of nitrate in each water sample (Sigman, et al., 2001; Casciotti et al., 2002; Révész and Casciotti, 2007). In this method, isotopes of both elements are measured simultaneously after the nitrate is converted to nitrous oxide (N_2O). Mass ratios of 45:44 and 46:44 distinguish $\delta^{15}\text{N}$ and $\delta^{18}\text{O}$ signatures, respectively.

Pseudomonas aurefaciens cultures were grown in tryptic soy broth, centrifuged to concentrate bacterial cells, and then concentrated suspensions of cells are added to sealed vials with headspace. *Pseudomonas aurefaciens* lacks N₂O reductase, the enzyme that converts N₂O to N₂ during denitrification, so the reaction stops at N₂O, unlike normal denitrification which converts most of the NO₃⁻ to N₂. The headspace vials were purged with helium gas to promote the anaerobic conditions suitable for denitrification, and the environmental samples containing NO₃⁻ were added to the vials and the volume of sample adjusted to obtain sufficient N₂O for analysis. Several drops of anti-foaming agent were added to each vial to reduce bubble formation during the reaction. The vials were allowed to incubate for 8 hours, during which time NO₃⁻ is converted completely to N₂O. After the 8-hour period, 0.1 ml of 10N NaOH was added to each vial to stop the reaction and to absorb CO₂ which can interfere with N₂O analysis. The samples were then placed on an autosampler tray interfaced with the mass spectrometer, and interspersed with standards with known $\delta^{15}\text{N}$ and $\delta^{18}\text{O}$ composition.

6.4 Results

A summary of the results of isotope analyses conducted on Marco Island samples by the UC Davis SIF is given in Appendix H, with laboratory documentation provided in Appendix H-1 and sample results provided in Appendix H-2. Selection criteria for sample analysis of stable isotopes were developed jointly by ERD and SIF and generally required a minimum NO_x concentration of 100 µg/l. Groundwater seepage samples are used to assist in identifying impacts from reuse irrigation and fertilization within the drainage basin.

6.4.1 Bulk Precipitation

A listing of the results of isotope analyses for nitrogen and oxygen conducted on bulk precipitation samples is given in Appendix H-2, and summary statistics for isotope analyses conducted on bulk precipitation is given in Table 6-3. Virtually all measured $\delta^{15}\text{N}$ values were near or less than zero while enriched in $\delta^{18}\text{O}$, indicating a lack of significant biological process as would be expected for an atmospheric source.

TABLE 6-3

SUMMARY STATISTICS FOR ISOTOPE ANALYSES CONDUCTED ON BULK PRECIPITATION SAMPLES

| SAMPLE ID | $\delta^{15}\text{N}_{\text{AIR}}$ (‰) | | $\delta^{18}\text{O}_{\text{VSMOW}}$ (‰) | |
|--------------------|--|---------|--|---------|
| | Range | Average | Range | Average |
| Bulk Precipitation | -4.02 – 1.18 | -0.86 | 55.90 – 67.66 | 62.82 |

A graphical summary of relationships between $\delta^{15}\text{N}$ and $\delta^{18}\text{O}$ for bulk precipitation samples is given on Figure 6-2. All collected samples are located in the range of $\delta^{15}\text{N}$ and $\delta^{18}\text{O}$ values characteristic of atmospheric deposition. The observed isotopic signatures for atmospheric deposition can be used to partition samples impacted by multiple sources.

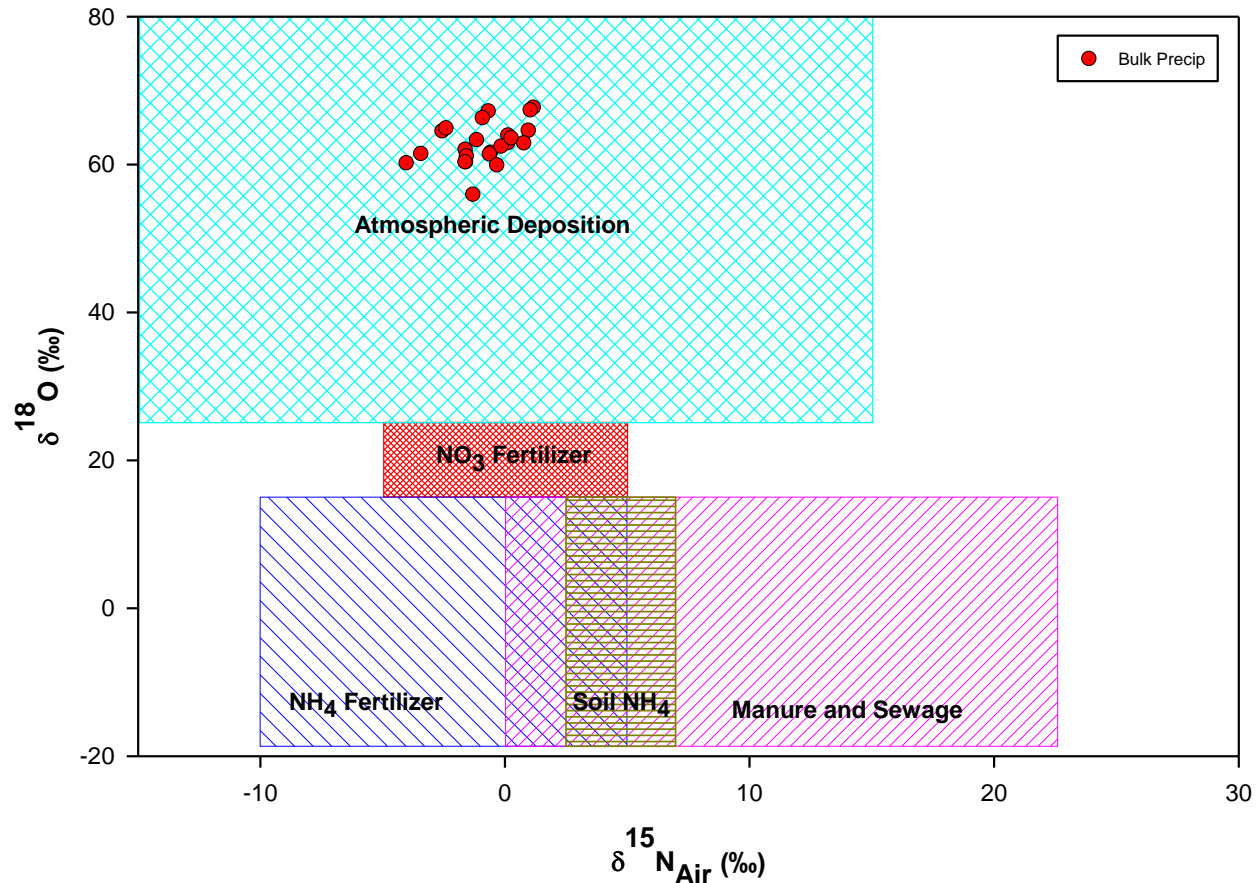

Figure 6-2. Relationships Between $\delta^{15}\text{N}$ and $\delta^{18}\text{O}$ for Bulk Precipitation Samples Collected at Marco Island.

6.4.2 Reuse Irrigation and Reuse Pond

A listing of the results of isotopic analyses for nitrogen and oxygen conducted on reuse irrigation samples and the golf course pond used to store reuse prior to use is given in Appendix H-2, and summary statistics for isotopic analyses on reuse irrigation and golf course pond samples is given in Table 6-4. Reuse samples contained moderately elevated values for both $\delta^{15}\text{N}$ and $\delta^{18}\text{O}$. Values of $\delta^{15}\text{N}$ are greater than values in atmospheric deposition, an indication of biological transformation of atmospheric nitrogen.

A graphical summary of relationships between $\delta^{15}\text{N}$ and $\delta^{18}\text{O}$ in reuse water is given on Figure 6-3. Virtually all reuse samples are constrained within typical reuse values for $\delta^{18}\text{O}$, while enrichment of $\delta^{15}\text{N}$ often exceeds typical limits for manure and sewage. However, the ranges for the boxes shown on Figure 6-3 are based on typical literature values, and the data suggest that the $\delta^{15}\text{N}$ values should be extended to include higher values of $\delta^{15}\text{N}$ for the Marco Island Water Reclamation Facility.

TABLE 6-4
SUMMARY STATISTICS FOR ISOTOPE ANALYSES
CONDUCTED ON REUSE IRRIGATION AND REUSE POND SAMPLES

| SAMPLE ID | $\delta^{15}\text{N}_{\text{AIR}}$ (‰) | | $\delta^{18}\text{O}_{\text{VSMOW}}$ (‰) | |
|------------------|--|---------|--|---------|
| | Range | Average | Range | Average |
| Reuse Irrigation | 15.76 - 31.41 | 22.89 | 4.62 - 14.79 | 9.73 |
| Reuse Pond | 2.90 - 16.53 | 12.20 | -0.69 - 18.38 | 11.22 |

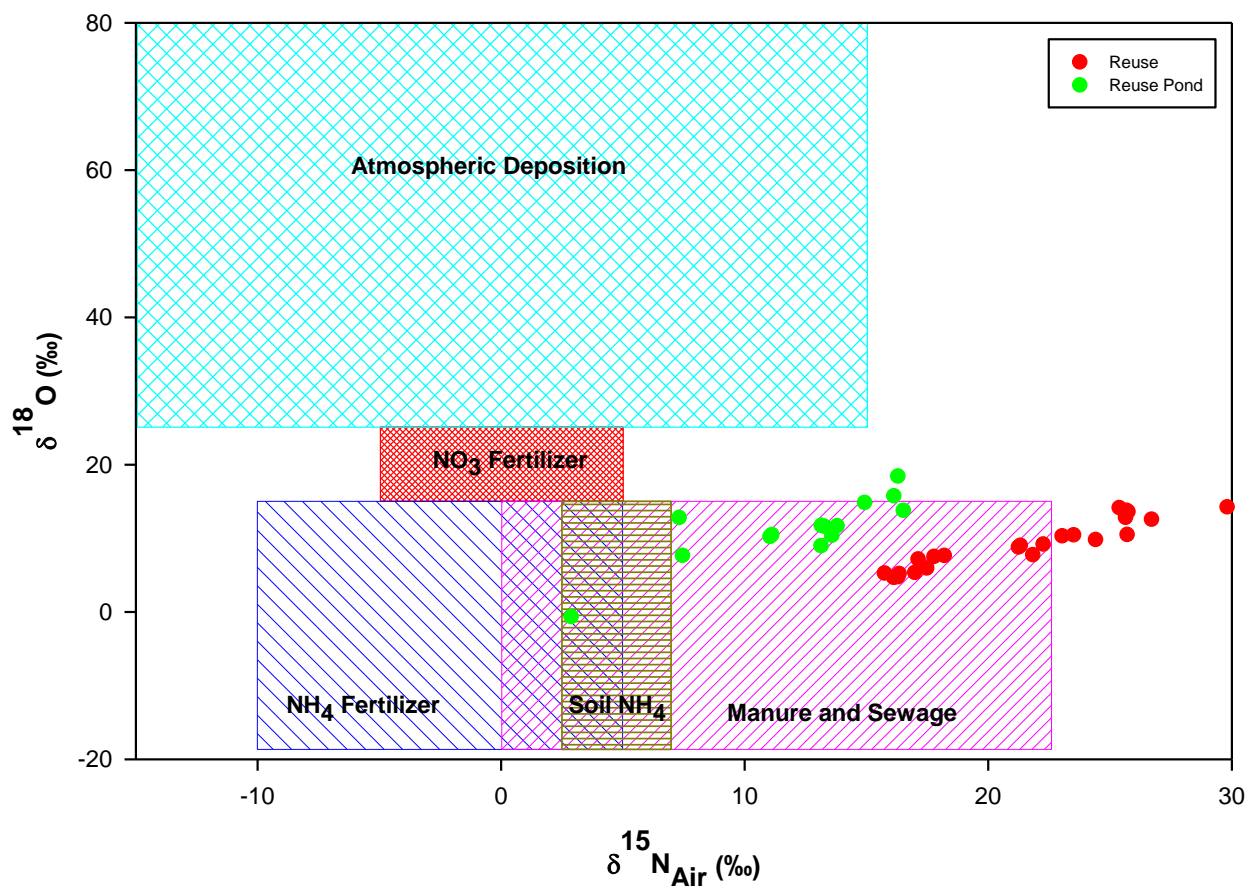

Figure 6-3. Relationships Between $\delta^{15}\text{N}$ and $\delta^{18}\text{O}$ for Reuse Irrigation and Reuse Pond Samples Collected at Marco Island.

The golf course reuse pond is used to store treated reuse water prior to use for irrigation. The pond contains an outfall structure which can be used to discharge excess reuse inflow to tide, and discharge conditions were observed by ERD on many occasions. As indicated in Table 6-4 and on Figure 6-3, water in the reuse pond has lower values for $\delta^{15}\text{N}$ and higher values for $\delta^{18}\text{O}$ than reuse samples which is likely due to dilution of the pond water by precipitation and groundwater inflows.

6.4.3 Runoff Samples

A listing of the results of isotope analyses for nitrogen and oxygen conducted on runoff and baseflow samples at the Marco Island monitoring sites is given in Appendix H-2, and summary statistics for isotope analyses conducted on runoff and baseflow samples is given in Table 6-5. Many of the measured $\delta^{15}\text{N}$ values were less than zero for the runoff samples, suggesting an inorganic fertilizer source. In contrast, the measured $\delta^{18}\text{O}$ samples exhibited a wide range of mostly positive values, reflecting samples with and without impact from biological processes.

TABLE 6-5

**SUMMARY STATISTICS FOR ISOTOPE ANALYSES
CONDUCTED ON RUNOFF / BASEFLOW SAMPLES**

| SAMPLE SITE | $\delta^{15}\text{N}_{\text{AIR}}$ (‰) | | $\delta^{18}\text{O}_{\text{VSMOW}}$ (‰) | |
|-------------|--|---------|--|---------|
| | Range | Average | Range | Average |
| MI-01 | -3.82 – 13.24 | 2.37 | 1.44 – 37.5 | 6.99 |
| MI-02 | -6.08 – 9.69 | 3.51 | -0.69 – 31.98 | 11.49 |
| MI-03 | -3.76 – 11.30 | 2.43 | -16.18 – 52.3 | 7.91 |
| MI-04 | -12.17 – 16.29 | 1.41 | -5.74 – 30.98 | 7.41 |
| MI-05 | -0.38 – 19.15 | 7.00 | -7.62 – 43.6 | 13.0 |

A graphical summary of relationships between $\delta^{15}\text{N}$ and $\delta^{18}\text{O}$ for the runoff and baseflow samples is given on Figure 6-4. A small portion of the nitrogen measured in runoff samples appears to be related to atmospheric deposition which is constrained by $\delta^{15}\text{N}$ values ranging from -20 to +15 and $\delta^{18}\text{O}$ values ranging from +25 to +80, as indicated on Table 6-1, suggesting that nitrogen concentrations in these samples primarily originate from nitrogen entrained in precipitation. The runoff samples collected as part of the Marco Island project were generated as a flow-weighted composite throughout the storm event. Runoff samples collected in this manner for small rain events generally show an isotopic signature of atmospheric deposition since atmospheric sources dominate early portions of a runoff event, and watershed sources do not begin contributing until later portions of a runoff event.

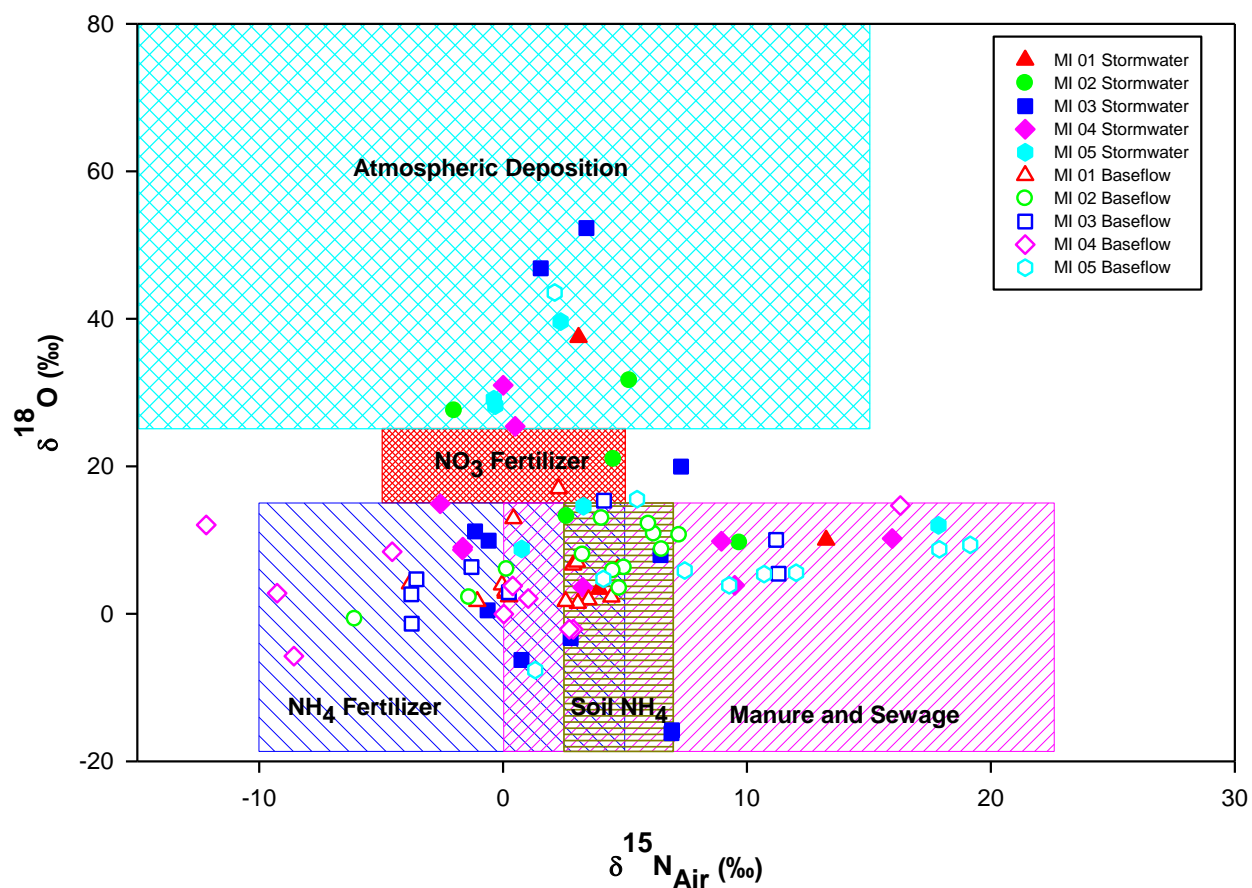

Figure 6-4. Relationships Between $\delta^{15}\text{N}$ and $\delta^{18}\text{O}$ for Stormwater and Baseflow Samples Collected at Marco Island.

However, the vast majority of collected runoff and baseflow samples indicated nitrogen signatures for NH_4 fertilizer, soil NH_4 , and manure and sewage. Nitrogen concentrations in baseflow samples appear to be dominated by NH_4 fertilizer, soil NH_4 , and manure and sewage. Signatures for NH_4 fertilizer and manure and sewage are present in some of the runoff and virtually all of the baseflow samples collected from Sub-basins 2, 3, and 5 which have reuse irrigation. Signatures from fertilizers and soil appear to be more common than reuse, suggesting that landscaping activities may be a more significant source of runoff nitrogen than reuse, although reuse impacts were observed in baseflow and runoff samples in Sub-basins 2, 3, and 5.

6.4.4 Groundwater Seepage

A listing of the results of isotope analyses for nitrogen and oxygen conducted on groundwater seepage samples is given in Appendix H-2, and summary statistics for seepage isotope analyses is given in Table 6-6. In general, seepage samples were characterized by low, and often negative, values for both $\delta^{15}\text{N}$ and $\delta^{18}\text{O}$.

TABLE 6-6
SUMMARY STATISTICS FOR ISOTOPE ANALYSES
CONDUCTED ON GROUNDWATER SEEPAGE SAMPLES

| SAMPLE SITE | $\delta^{15}\text{N}_{\text{AIR}}$ (‰) | | $\delta^{18}\text{O}_{\text{VSMOW}}$ (‰) | |
|-------------|--|---------|--|---------|
| | Range | Average | Range | Average |
| SP-1 | -0.5 – 3.22 | 0.91 | -6.81 – 1.87 | -1.69 |
| SP-2 | -2.84 – 5.51 | 2.98 | 0.50 – 5.96 | 2.75 |
| SP-3 | -1.34 – 3.62 | 1.18 | 1.04 – 6.54 | 3.98 |
| SP-4 | 9.87 – 3.92 | -4.34 | 2.0 – 3.2 | 0.70 |
| SP-5 | -6.74 – 4.83 | -3.35 | -3.90 – 6.41 | -0.16 |
| SP-6 | -25.7 – 3.38 | -2.55 | -2.46 – 6.76 | 3.54 |
| SP-7 | -6.51 – 6.09 | 1.17 | -1.55 – 2.27 | 0.57 |
| SP-8 | -5.97 – 5.61 | -0.03 | 0.86 – 7.93 | 4.43 |
| SP-9 | -1.91 – 3.23 | 1.38 | -8.65 – 3.22 | -1.83 |
| SP-10 | -19.63 – 3.23 | -4.53 | -12.6 – 1.96 | -3.17 |
| SP-11 | -5.34 – 5.43 | 1.31 | -7.32 – 8.50 | 1.90 |
| SP-12 | -1.15 – 9.77 | 3.93 | -11.8 – 2.58 | -0.67 |
| SP-13 | -10.3 – -2.13 | -5.06 | -5.26 – 4.74 | -0.03 |
| SP-14 | -7.78 – 1.63 | -2.81 | -7.50 – 1.77 | -2.82 |
| SP-15 | -2.38 – 1.46 | -0.28 | -5.47 – 2.26 | -0.64 |

A graphical summary of relationships between $\delta^{15}\text{N}$ and $\delta^{18}\text{O}$ for groundwater seepage samples is given on Figure 6-5. With only one exception out of 74 seepage samples submitted for isotopic analysis, signatures for nitrogen in seepage indicated impacts from fertilizer and soil NH_4 . The clustering of points on Figure 6-5 is quite conclusive and suggests that the landscaping activities are a significant source of nitrogen to groundwater.

6.5 Summary

The isotopic data make a strong case for landscaping activities and reuse irrigation as significant sources of nitrogen in groundwater seepage inflows to Marco Island waterways. An isotope signature indicating impacts from both fertilizer and reuse irrigation was observed in about 40% of the seepage samples, with the remaining samples dominated by fertilizer impacts. Nitrogen inputs to runoff and baseflow appear to be impacted by a variety of sources, including rainfall, fertilizer, and reuse activities, although the isotope data suggest that landscaping activities may be a more significant source than reuse irrigation in runoff samples, while reuse irrigation has a strong impact on baseflow characteristics. This information is used to develop nutrient management recommendations for the Marco Island waterways.

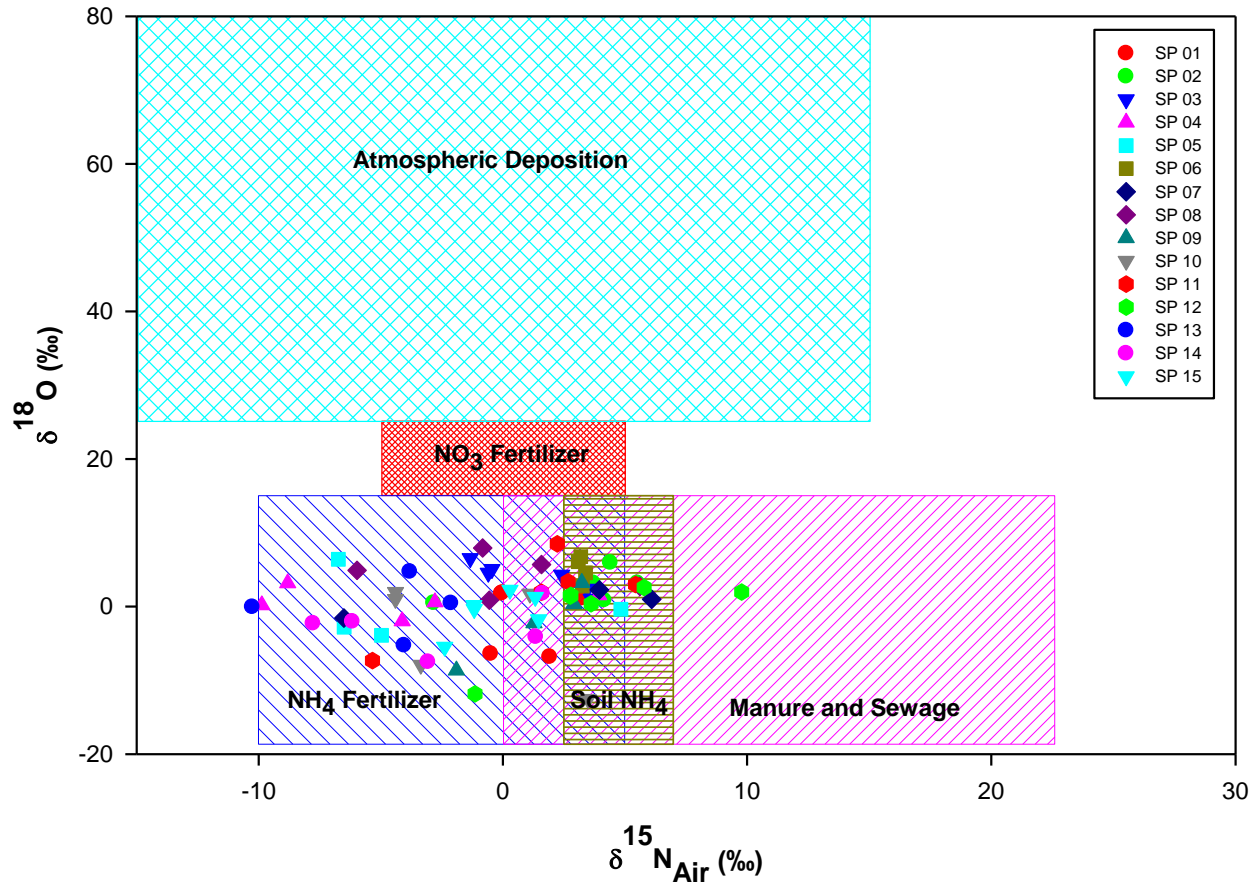

Figure 6-5. Relationships Between $\delta^{15}\text{N}$ and $\delta^{18}\text{O}$ for Groundwater Seepage Samples Collected at Marco Island.

SECTION 7

EVALUATION OF WATER QUALITY IMPROVEMENT OPTIONS

A discussion of water quality maintenance and improvement options for Marco Island waterways is presented in this section. The evaluated water quality improvement options are designed to target sources which have been identified as significant contributors of nutrient loadings to the waterways. Based on the historical and current field monitoring, it appears that nitrogen is the primary nutrient which must be controlled to maintain and improve water quality characteristics. Nitrogen inputs to the waterways occur through a wide variety of sources including bulk precipitation, stormwater runoff, irrigation water, groundwater seepage, and internal recycling, and the management plan is based upon identifying and treating the most significant treatable sources. The evaluated options include both structural and non-structural approaches to controlling and reducing nitrogen inputs.

A discussion of general management philosophy and recommended water quality improvement projects is given in the following sections. The water quality management recommendations in this section are based on over 100 years of combined experience by ERD personnel in surface water management and provide an independent, science-based approach to improving water quality in Marco Island waterways. The recommendations provide a series of guidelines for controlling existing and future nutrient loadings to the waterways but are not intended to be used for purposes of regulatory or policy decisions.

7.1 Management Philosophy

7.1.1 Water Quality Dynamics and Limitations

Marco Island is an island community located in southern Collier County about 20 miles south of Naples, and is the largest Barrier Island within southwest Florida's Ten Thousand Islands. The island is surrounded by multiple bays and islands which receive inflows from large wetland areas located west of US 41, along with portions of the Florida Everglades which are often colored and contain elevated nutrient concentrations. When these inflows combine with tidal waters, the resulting water quality characteristics represent baseline water quality in off-shore areas surrounding Marco Island. This water moves into and out of the extensive canal system with each tidal cycle and creates baseline minimum water quality in the island waterways. When the tidal water enters the waterway canals, nutrient concentrations are enhanced by watershed inputs from precipitation, runoff, irrigation water, and groundwater seepage. It would be virtually impossible to improve waterway quality to levels less than present in the inflows, and the baseline conditions cannot be improved without significant regional projects to improve the characteristics of upland inflows to the off-shore waters. Therefore, the emphasis of the water quality management options discussed in this section is to reduce enhancement of loadings to the baseline conditions, realizing that the maximum achievable water quality improvement is limited by the characteristics of off-shore water.

Both Marco Island waterways and off-shore waters are currently listed as Impaired Waters by FDEP, with Marco Island waterways listed as impaired for nitrogen and off-shore water listed as impaired for nitrogen, phosphorus, and fecal coliform bacteria. Since the baseline water entering the waterways is already impaired, Marco Island waterways will continue to be impaired until the impairment is addressed in the off-shore waters, a point discussed in the Terrell Report and in multiple presentations by Mr. Eugene Wordehoff. Even if Marco Island eliminated all inputs of water and nutrients to area waterways, the water quality impairment within the waterways would remain since the incoming water is already impaired. However, although little can be done by the City to eliminate the current impairment, both historical and current monitoring efforts indicate an enrichment in nutrients within the waterways compared with off-shore waters, and the water quality management options discussed in this section are designed to reduce the enrichment processes to prevent further degradation of inflows after entering the canal systems.

A summary of geometric mean water quality characteristics at off-shore monitoring sites during the ERD field monitoring program from April-September 2020 is given in Table 7-1. Geomean concentrations are included for total nitrogen, total phosphorus, and chlorophyll-a at each of the 4 off-shore sites. The lowest concentrations of total nitrogen and chlorophyll-a occur at the Gulf of Mexico and Caxambas sites, but there are no channel locations on the west side of the island which receive direct inflows from the Gulf, although water from Caxambas Bay does flow into waterways associated with Sub-basins 4 and 5. Inflows to waterways for Sub-basins 2 and 3 come from Marco Bay and East Marco Bay where the baseline water quality already exceeds the NNC for total nitrogen and chlorophyll-a by a factor of 2 or more. Water collected from the Gulf of Mexico by ERD from April-September 2020 indicated consistent violations of the NNC for both total nitrogen and chlorophyll-a.

TABLE 7-1

**GEOMETRIC MEAN CONCENTRATIONS AT OFF-SHORE
MONITORING SITES FROM APRIL-SEPTEMBER 2020**

| SITE | LOCATION | TOTAL NITROGEN (µg/l) | TOTAL PHOSPHORUS (µg/l) | CHLOROPHYLL-A (µg/l) |
|-------------|-----------------|--------------------------------------|--|---------------------------------|
| M-1 | Marco Bay | 584 | 38 | 10.4 |
| M-2 | East Marco Bay | 618 | 42 | 14.9 |
| M-3 | Gulf of Mexico | 579 | 35 | 9.0 |
| M-4 | Caxambas Bay | 517 | 43 | 7.8 |

ERD has been copied on correspondence between island residents and elected officials regarding complaints of “poor” water quality. Both historical and current monitoring efforts clearly document violations of applicable NNC which is manifested visually in the form of algal growth or blooms. Photographs of “poor” water quality have been provided to ERD by local residents, and the water quality issues have been observed directly by ERD.

Photographs of canal water, taken by local residents and ERD field personnel, are shown on Figure 7-1. Each of these photographs illustrate water quality concerns from material floating on the surface, but the floating material is not necessarily related to excessive nutrients. Some of the photos appear to show surface scum from pollen, vegetation debris, and perhaps zooplankton which feed on algae, while the floating foam results from organic molecules generated by decomposition of organic matter. Photographs taken by ERD show floating patches of vegetation and grass clippings from on-shore areas. Each of these items tends to accumulate in undisturbed or stagnant areas near boat docks. This material is visually unaesthetic and should be addressed as part of a management plan, but this type of pollution originates from issues other than elevated nutrients and chlorophyll-a.

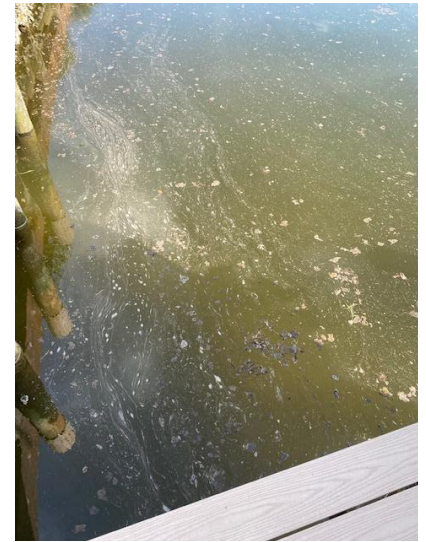

a. Photographs provided by area residents



b. Photographs taken by ERD

Figure 7-1. Photographs of Observed Water Quality Issues.

There is no “silver bullet” that will magically solve the existing water quality issues in the Marco Island waterways. There are multiple sources impacting nutrient loadings, and water quality improvement requires removal of nitrogen which is more difficult and less predictable than removal of phosphorus. Removal of nitrogen is also considerably more expensive than phosphorus and less understood. However, this report provides a series of recommendations for options with the greatest likelihood of reducing nitrogen loadings to area waterways.

7.1.2 Significance of Nutrient Sources

7.1.2.1 Sediment Nutrient Recycling

Hydrologic and nutrient budgets were developed for each of the 5 sub-basin areas discharging to Marco Island waterways which included inputs from bulk precipitation, stormwater runoff, groundwater seepage, irrigation, and sediment internal recycling. The most significant source of nitrogen loading to the waterways is sediment nutrient release which contributed 60.5-77.4% of the annual nitrogen loadings. In freshwater systems where phosphorus is the limiting nutrient, sediment nutrient release can be easily and economically controlled using a targeted application of aluminum sulfate (commonly called alum) which binds sediment phosphorus in an insoluble form. However, there is no equivalent precipitating compound or technology for retaining nitrogen in the sediments. The application of alum to sediments reduces the level of microbial activity in sediments and often indirectly reduces nitrogen release simultaneously with phosphorus. The chemistry of aluminum in saltwater sediments becomes quite complex, and this technology has never been tested in marine systems. Outside of dredging, which would be prohibitively expensive and unacceptably intrusive, there is little that can be done to eliminate this significant source, although it may be possible to reduce the annual loadings.

Field monitoring conducted by ERD from April-September 2020 indicated differences in oxygen regimes at sites located in upstream and downstream portions of the canal system. In downstream areas, such as Site M-9 (Figure 2-18), relatively isograde vertical profiles were observed for temperature, pH, and dissolved oxygen during all events at this site to the bottom at a depth of 5 m (16.4 ft), indicating a well-mixed water column. However, oxygen depletion was observed at the same 5 m depth during virtually all events at Site M-11 (Figure 2-19) which is located at the terminal end of a wide deep canal with little tidal exchange. As illustrated in Table 5-13, sediment nutrient release is 2-3 times greater under anoxic conditions compared with aerobic conditions, so enhanced recirculation which maintained aerobic conditions throughout the waterways could be used to reduce sediment nutrient release

7.1.2.2 Groundwater Seepage

Groundwater seepage is the second most significant source of nitrogen loading to the waterways, contributing 14.6-30.1% of the annual loading depending on the individual sub-basin. Seepage originates within the upland areas of each sub-basin and includes all potential groundwater inputs from precipitation, infiltrated runoff, and irrigation. Upon entering groundwater, the water moves down-gradient through the soil layer toward the closest waterway where the groundwater flow migrates beneath the seawalls and seeps up through the bottom of the canals.

There are two potential mechanisms for reducing nitrogen inputs to groundwater. The most obvious option is to reduce potential nitrogen sources before entering groundwater. Nothing can be done to reduce loadings from precipitation, but options are available to reduce loadings from runoff and irrigation, and these issues are discussed in a later section.

Nitrogen is notoriously difficult to remove in general, but recent research has indicated that denitrification walls can be effective in reducing nitrogen concentrations in seepage. These systems consist of a 1-2 ft thick vertical wall of special media containing a degradable carbon source that creates conditions conducive for denitrification, and these are currently under consideration for reducing nitrogen loadings to the Indian River Lagoon (IRL). Denitrification walls placed on the landward side of the retaining walls are a potential option which is discussed in a later section.

7.1.2.3 Stormwater Runoff

Stormwater runoff is the third most significant source of nitrogen loading to the waterways, but the annual contribution only accounts for 2.8-8.7% of the total annual inputs. Runoff monitoring conducted at the 5 monitoring sites indicated that Marco Island runoff already contains low levels of total nitrogen which is one-third to one-half of concentrations commonly observed in runoff from similar land use categories in other parts of Florida. Concentrations of particulate nitrogen, which often comprise the most dominant nitrogen form in runoff, are extremely low in value at Marco Island which is presumably due to the substantial pre-treatment for particulate matter achieved in the extensive grassed swale system used for runoff conveyance throughout the island.

Due to the highly permeable soils, most of the runoff is infiltrated into groundwater with only a small portion of the generated runoff reaching waterways as direct runoff. Other than a constructed stormwater pond or treatment facility, a swale drainage system is the best option for treating runoff. Therefore, ERD does not propose any significant structural stormwater projects other than routine maintenance of the existing system which is discussed in a subsequent section.

7.1.2.4 Reuse Irrigation

The ERD study devoted considerable effort to analyzing the chemical characteristics and potential impacts from reuse irrigation. As discussed in Section 3.8, an average daily quantity of approximately 2 MGD of reuse irrigation water is applied to golf courses and public access areas on Marco Island. Both the historical water quality data and independent measurements conducted by ERD indicate extremely elevated and highly variable concentrations of both nitrogen and phosphorus in reuse compared with measured characteristics in the waterways or stormwater runoff. Reuse application in the 5 sub-basins contributes approximately 1,581 ac-ft/yr which is 6% of the total annual hydrologic inputs of 27,373 ac-ft/yr to the 5 sub-basins from all sources.

A comparison of geomean concentrations for significant seepage sources is given in Table 7-2 which does not include additional nitrogen inputs from fertilizers. The primary premise behind using treated wastewater as an irrigation source is that the nitrogen will be absorbed by the surface vegetation and have no impact on groundwater characteristics. However, it is easy to see that excess reuse irrigation has the potential to significantly enhance nitrogen concentrations in groundwater and the resulting seepage to adjacent waterways.

TABLE 7-2
COMPARISON OF GEOMEAN TOTAL NITROGEN
CONCENTRATIONS IN SIGNIFICANT SEEPAGE SOURCES

| SUB-BASIN | GEOMETRIC MEAN TOTAL NITROGEN CONCENTRATIONS ($\mu\text{g/l}$) | | | |
|-----------|---|--------|-------|---------|
| | Precipitation | Runoff | Reuse | Seepage |
| 1 | 273 | 606 | 8,630 | 1,160 |
| 2 | 273 | 467 | 8,630 | 1,272 |
| 3 | 273 | 1,128 | 8,630 | 1,633 |
| 4 | 273 | 1,098 | 8,630 | 1,063 |
| 5 | 273 | 521 | 8,630 | 905 |

The isotopic evaluation conducted by ERD indicated the presence of signatures of manure and sewage in 16 of the 48 stormwater and baseflow samples (33%) collected at Sub-basins 2, 3, and 5 where reuse irrigation is applied which indicates that reuse irrigation does impact runoff characteristics. A signature of reuse irrigation was also observed in runoff and baseflow at Site 4 (residential area with high maintenance) where reuse is not available for public use, but reuse irrigation is applied to the landscaped medians on a periodic basis. Methods of reducing reuse irrigation impacts are discussed in a subsequent section.

7.1.2.5 General Management Options

In addition to the proposed management options summarized previously, recommendations are also included for non-structural techniques such as street sweeping, fertilizer and landscape management, and educational campaigns to inform homeowners about the link between homeowner activities and water quality. Although the specific benefits of these options are difficult to quantify, they reflect sound management practices which should be part of every community and, therefore, are included as part of the management plan.

7.2 Reduction of Loadings from Internal Recycling

Based upon the field monitoring and sediment incubation experiments conducted by ERD, it is apparent that the existing sediment accumulations contribute the most significant nitrogen loading to the waterways each year, and water quality within the waterways could be improved by reducing the observed internal nitrogen loadings. There are several basic methods which have been used in surface water management projects to mitigate impacts from internal recycling. Sediment dredging has been used in both marine and freshwater systems to remove the accumulated sediments and the source of nutrient release. Although sediment dredging is virtually impossible in Marco Island waterways, and ERD does not recommend dredging as a water quality management tool, a discussion of sediment dredging is given in the following sections for comparison with other options.

Inactivation of sediment phosphorus release using a phosphorus-binding agent, such as alum, is common in lakes and has been highly effective in improving water quality and reducing algal blooms but has not been tested in marine systems. Establishment of submerged vegetation has also been shown to reduce nutrient sediment release by creating a competing uptake mechanism and maintaining oxidized conditions at the water-sediment interface. Another option is to increase the oxygen content of the water and circulation rates to limit nutrient release to aerobic conditions which exhibits a much lower release rate. Options related to re-establishment of submerged vegetation and water recirculation are addressed in later sections.

7.2.1 Sediment Dredging

Sediment dredging is a technique which reduces internal recycling by removing the existing organic muck, leaving the original parent bottom material of the waterbody. This option is designed to reduce water quality impact from the existing sediments, with added benefits of increasing water depth and water volume.

A decision to remove accumulated bottom sediments generally occurs when there is sufficient evidence that the accumulated sediments are having an adverse impact on habitat, water quality, recreation, or navigation. The existing sediments in the Marco Island waterways do not appear to have a direct impact on recreation or navigation, but field and laboratory work conducted by ERD demonstrated an adverse impact of the sediments on existing water quality.

7.2.1.1 Dredging Methods

Sediment removal by dredging can be accomplished by either mechanical or hydraulic dredging methods. Mechanical dredging in canals can be accomplished using a shoreline-based dragline, but mechanical dredging in lakes most frequently involves either partially or completely draining the lake to expose the sediments to drying conditions. Conventional earth-moving equipment, such as bulldozers, scrapers, backhoes, and draglines, are then used to remove the dried sediments. The sediment material is stockpiled on the shore and then hauled away in dump trucks to a disposal location. This technique was used routinely by the Florida Fish and Game Commission during the 1970s and 1980s, but improvements in water quality were limited.

Given the size of the Marco Island waterway system, the direct hydraulic connection to tidal waters, high water table, large numbers of docks, extensive boating activities, and importance of the waterways for removing excess water, it is highly unlikely that even a relatively small portion of any waterway could be dried enough to allow mechanical dredging to occur. Even if portions of a waterway were isolated using sheetpile, continuous seepage of groundwater inflow would make adequate dewatering of these areas extremely difficult. Access to the waterways for earth-moving equipment would be nearly impossible given the dense residential development and roadway systems surrounding all waterways.

The most likely option for dredging in Marco Island waterways would be hydraulic dredging. During hydraulic dredging, a hydraulic dredge excavates and pumps material from the bottom through a temporary HDPE pipeline to an off-site location which is often several thousand feet to several miles away. The head of the dredging unit is equipped with a rotating cutter with steel blades to dislodge and homogenize the sediments, and a centrifugal pump is used to “suck up” the muck and water mixture, forming a slurry. Control of the dredging depth occurs by manipulation of the suction head in both a vertical and horizontal direction. Since water is removed along with the sediment, hydraulic dredging slurries are commonly 80-90% water. An advantage of hydraulic dredging is that it is generally faster than mechanical dredging, does not require dewatering, and creates less turbidity in the dredged waterbody. Hydraulic dredging is also often the most cost-effective method for large dredging projects. As a result, this analysis will assume that the proposed dredging is accomplished in Marco Island using a hydraulic dredge.

7.2.1.2 Containment Area Requirements

The dredged sediment material would be pumped to a disposal area where the sediments would be allowed to dewater and dry out over time, and the clarified water may or may not be returned to the place of origin, depending on the location of the containment pond. The disposal area must be sufficient in size to hold not only the dredged sediments, but also the large volume of pumped sediment/water slurry that occurs during the actual dredging process. When sediments are formed into a slurry by the dredge, the volume of the sediments tends to increase temporarily which is referred to as the “bulking factor”. This additional volume must also be considered when designing the disposal basin. Bulking factors ranging from 1.2-1.5 are typical, with a factor of 1.5 assumed for Marco Island.

A summary of dredging design assumptions and containment area requirements for Marco Island sediments is given on Table 7-3. Although the sediment volume is not known, this analysis assumes a waterway area of 1,525 acres (Table 3-3) and an average sediment depth of 1.5 feet. The resulting sediment volume is approximately 2,288 ac-ft which would be removed during the dredging process, equivalent to approximately 3,690,500 yd³. Assuming a bulking factor of 1.5, the total volume of sediment/water slurry which must be contained within the containment area is 5,535,750 yd³ assuming that all waterways were dredged at the same time.

Containment areas are commonly constructed on relatively flat ground, with a berm around the perimeter to contain the dredged slurry. To minimize stability issues associated with the containment berm, the depth of the dredged slurry is frequently limited to approximately 3-4 ft. An additional freeboard of approximately 1 ft would also be incorporated into the design to provide an average berm height of approximately 5 ft with a maximum slurry depth of 4 ft. Based upon these criteria, the required containment area for hydraulic dredging of Marco Island sediments would be approximately 686 acres. Assuming an additional 20% area for roadways and access to various portions of the containment area, the total required site area would be approximately 824 acres. The containment site would ideally be located close to the waterway being dredged, although remote locations can also be utilized at an increased unit cost. Assuming 0.50-acre lots, the containment area is equivalent to approximately 1,648 residential lots.

TABLE 7-3

**SUMMARY OF DREDGING DESIGN ASSUMPTIONS AND
CONTAINMENT AREA REQUIREMENTS FOR MARCO ISLAND**

| PARAMETER | UNITS | VALUE |
|---|-----------------|-------------|
| Existing Sediment Volume | ac-ft | 2,288 |
| | ft ³ | 99,665,280 |
| | yd ³ | 3,690,500 |
| Assumed Bulking Factor | -- | 1.5 |
| Containment Area Volume | ac-ft | 3,432 |
| | ft ³ | 149,497,920 |
| | yd ³ | 5,535,750 |
| Assumed Containment Area Depth, with 1 ft Freeboard | ft | 5 |
| Required Containment Area (4-ft slurry depth) | acres | 686 |
| Disposal Site Area with 20% Buffer | acres | 824 |

7.2.1.3 Dredging Costs

Costs for hydraulic dredging typically range from approximately \$15-40/yd³ which includes the actual dredging, pumping of the dredged slurry to the containment area, construction of containment area berms, construction of a return water discharge from the containment area, expenses for treatment of the dredged slurry to meet discharge requirements, and in some cases, post-dredging restoration of the containment site. The variability in cost is a function of accessibility, length of slurry pipeline required, and the composition and dewatering characteristics of the sediment material. Pumping the sediment slurry long distances to remote disposal sites often requires booster pumping systems which add substantially to the project cost.

No significant vacant parcels currently exist in the Marco Island drainage basin which could accommodate the proposed containment area, so an off-shore parcel would need to be obtained. Land costs for these parcels are assumed to be approximately \$50,000/acre, although costs could be substantially higher. For purposes of estimating dredging costs, an assumed dredging cost of \$40/yd³ is used.

A summary of estimated costs for hydraulic dredging of Marco Island sediments is given in Table 7-4 and includes costs for dredging, land costs for the disposal area, and engineering design and testing. The estimated dredging cost for removal of 3,690,500 yd³ of material from Marco Island is conservatively estimated at approximately \$147,620,000. This value does not include any cost associated with land purchase which may be required for the containment area. Assuming that land purchase is required, the estimated cost for 824 acres of vacant off-shore land at a cost of \$50,000/acre is \$41,200,000. An additional \$1,000,000 is included for engineering, design and testing during the dredging feasibility analysis phase, and dredging oversight. The estimated total project cost with land purchase is approximately \$189,820,000. However, a portion of the total cost may be recovered by restoring and selling the land required for the disposal area when dredging is completed.

TABLE 7-4

**ESTIMATED COSTS FOR HYDRAULIC
DREDGING OF MARCO ISLAND SEDIMENTS**

| PARAMETER | UNITS | VALUE |
|--------------------------------|--------------------|--------------------|
| Sediment Volume | yd ³ | 3,690,500 |
| Assumed Dredging Cost | \$/yd ³ | 40 |
| Dredging Cost | \$ | 147,620,000 |
| Assumed Land Costs (824 acres) | \$ | 41,200,000 |
| Engineering/Design | \$ | 1,000,000 |
| TOTAL COST: | \$ | 189,820,000 |

It is unlikely that dredging of Marco Island sediments would completely eliminate internal recycling for several reasons. First, previous evaluations of dredging projects have indicated that dredging is rarely 100% effective in removing sediments, and isolated pockets of sediments will remain which redistribute over the bottom of the waterway, contributing a continued internal loading. Second, the parent material which is exposed as a result of the dredging may also have a limited nitrogen release in spite of sediment removal. Finally, water quality improvements from previous dredging projects have been highly variable.

7.2.1.4 Summary

An evaluation was conducted for hydraulic dredging of Marco Island sediments to reduce internal recycling. The anticipated dredging cost is conservatively estimated to be approximately \$190 million, assuming that additional land purchase will be required for a containment area for the dredged slurry. It is unlikely that the sediment removal project would eliminate all of the existing nutrient recycling.

7.3 Stormwater Management

As discussed in Section 7.1.2.3, direct inputs of nitrogen to the waterways from stormwater runoff are relatively minimal in comparison with other sources, and no significant structural stormwater management options are recommended. The stable isotope analyses, discussed in Section 6, indicate a signature of reuse irrigation in both runoff and baseflow even in sub-basins where reuse is used only for irrigation of landscaped street medians.

7.3.1 Nutrient Management

The primary method of conveying runoff in Marco Island is through the extensive system of grassed swales used in virtually all areas except commercial and multi-family land use. Photographs of a typical swale system under dry and wet conditions are given in Figure 7-2. Swales provide extremely good pre-treatment for runoff by removing particulate matter and slightly reducing inorganic nitrogen. Swales have a tendency to become filled over time from accumulated particles present in runoff and adjacent streets, and maintenance of swales is critical to proper conveyance and runoff attenuation. Swales are often considered to be a Low Impact Development (LID) technique to reduce runoff impacts.



a. Swale system between storm events



b. Swale system during storm events

Figure 7-2. Typical Grassed Swale Systems Used at Marco Island.

During the field monitoring program, ERD noticed a wide range of swale types on Marco Island, ranging from relatively deep systems to shallow swales with minimal depression. Much of this variability is due to changes in land use and available land area, but some of it is certainly due to gradual filling. As solids accumulate over time, swales need to be configured to maintain functionality, and ERD recommends that the City conduct an inventory of existing swales and schedule maintenance activities as necessary.

The reason why direct runoff impacts are minimal on Marco Island is that more than 90% of the generated runoff either evaporates or infiltrates into shallow groundwater and becomes part of the seepage loading, converting much of the loading from a surface water load to a groundwater load, although at a lower concentration due to uptake by vegetation and soil in the vadose zone. Since much of the runoff is infiltrated within the swale system, a treatment process could be incorporated into the swales specifically to provide additional reductions in nitrogen loadings.

7.3.1.1 Swale Blocks

Two potential methods are available to enhance the performance of the existing swale systems for retaining nutrients. The first technique is to enhance the retention and infiltration of runoff within the swale system using small grassed berms placed perpendicular to the swale flow direction. These berms, often referred to as swale blocks, provide a series of small retention areas which retain or detain runoff, increasing the opportunity for infiltration into groundwater and nutrient reduction through soil filtration and plant uptake. This is a common Low Impact Development (LID) technique. Implementation of this may require a hydrologic study to evaluate potential flooding impacts. Installation of swale blocks could be easily completed by existing Public Works personnel during swale maintenance activities.

Swale blocks are generally a few inches to more than a foot in height, depending on the swale characteristics. On Marco Island, swale blocks in most areas would be less than 6 inches tall. The swale block is constructed of compacted earth which is sodded to match the swale turfgrass. The site slopes longitudinal to the direction of flow and are tapered to facilitate mowing.

A photograph of a swale block installed in a swale drainage system in Orlando is given on Figure 7-3. The swale block was constructed at a height of approximately 12 inches but is hardly visible due to the sloping sides. Swale blocks can be constructed to accommodate virtually any swale configuration. The retained runoff receives filtration in the soil and reduces runoff loadings compared with runoff which discharges to tide.



Figure 7-3.
Example of a Typical
Swale Block.

Swale blocks are inexpensive to construct and only require some fill dirt and sod. It is important to compact the earthen portion of the swale block prior to sod placement to prevent erosion and channeling. Costs for swale blocks vary depending on the type of channel, soil types, slope, and vegetation cover, but for purposes of this analysis a cost of \$250/block is assumed. This task could be easily achieved by existing personnel during maintenance activities.

7.3.1.2 Denitrification Bed

One of the most effective methods of removing nitrogen is through denitrification. Denitrification is a microbially-mediated process that occurs under anaerobic conditions and is used extensively in the wastewater industry for nitrogen removal. A schematic of the denitrification process is given in Figure 7-4. Denitrification converts inorganic forms of nitrogen into a gaseous product which is dispersed into the atmosphere. The process requires a wet environment void of oxygen with a degradable carbon source used for electron transfer.

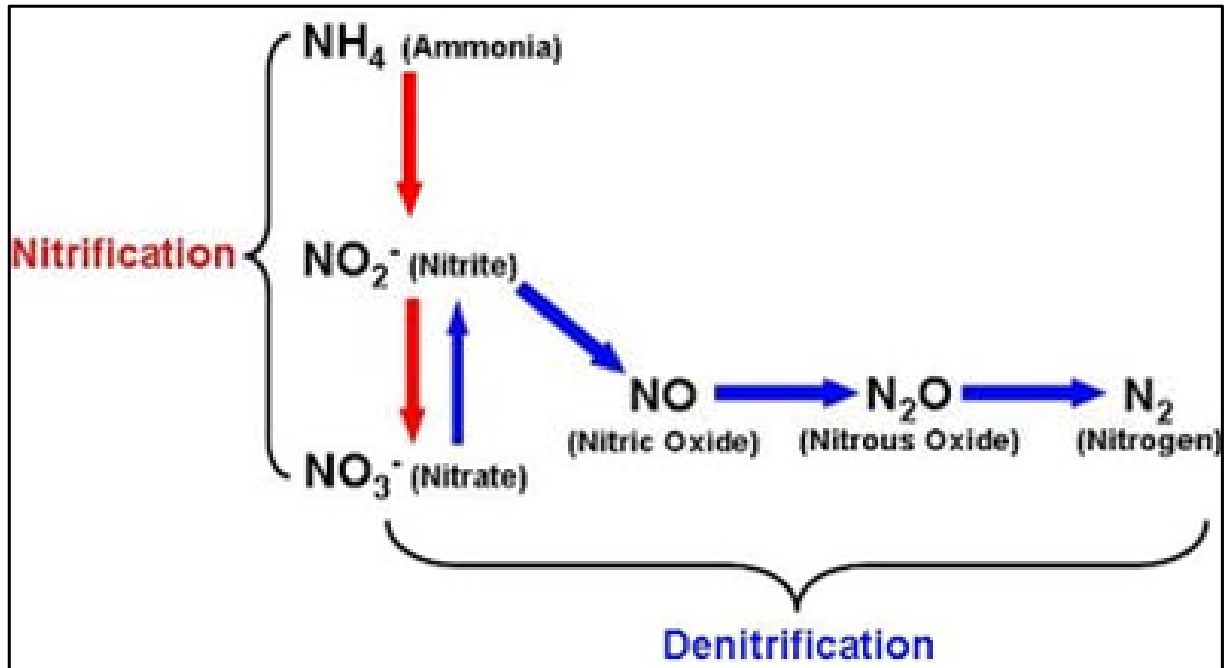

Figure 7-4. Schematic of Denitrification Process.

In recent years denitrification has been adapted for treatment of runoff and groundwater seepage. Nitrogen loadings to groundwater could be reduced by incorporating a denitrification bed into the bottom of the existing swale systems. An example of this system is given on Figure 7-5. The denitrification bed consists of a layer of media, referred to as biologically activated media (BAM), which contains a substrate to which the bacteria become attached, a degradable carbon source (such as wood chips or sawdust), and a mixture of sand to regulate permeability of the layer. The media is designed to provide a wet, anaerobic environment conducive to denitrification to occur; and saturation of the media, which would likely occur frequently under Marco Island conditions, would assist in maintaining the desired optimal environment. Multiple commercial media products are currently available.

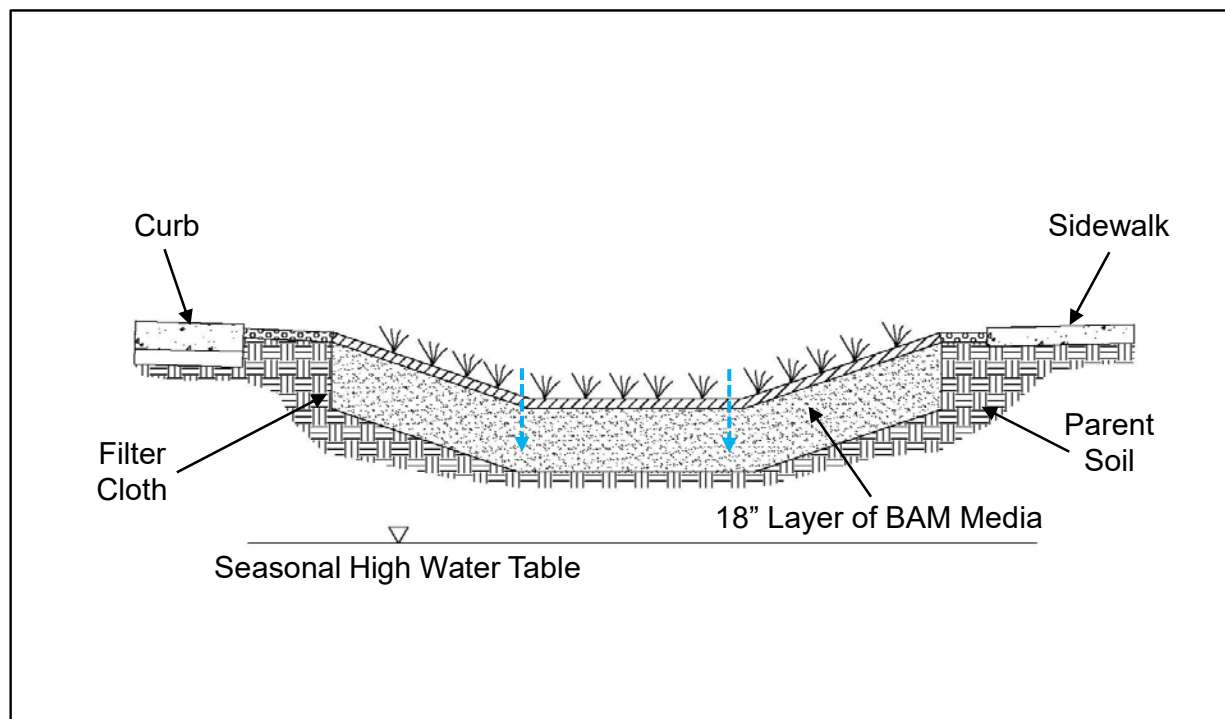

Figure 7-5. Example of Denitrification Bed Incorporated into Existing Swales.

Denitrification processes can only utilize inorganic forms of nitrogen such as ammonia (NH_4) and nitrate (NO_3), cumulatively referred to as dissolved inorganic nitrogen (DIN), so removal processes and efficiencies are limited to the amount of these forms present. Generally, denitrification only occurs at a significant rate at DIN concentrations in excess of $100 \mu\text{g/l}$, and minimum concentrations of DIN in runoff and baseflow samples collected during the field monitoring program exceed this value in all sub-basins except Sub-basins 2 and 5. Therefore, conditions appear to be favorable for use of denitrification beds in Sub-basins 1, 3, and 4. The proposed denitrification beds could be installed in swales as a stand-alone project or gradually incorporated into the swales during maintenance activities which require regrading.

The longevity of BAM media for removing nitrogen varies with on-site conditions and concentrations of DIN. Since nitrogen removal is achieved using a biological process, nitrogen removal can continue indefinitely as long as conditions are conducive for the required bacterial species. However, the limiting factor for longevity is often the carbon source. Carbon is used for exchange of electrons for the denitrification reaction and is consumed in the process. The quality of the carbon source determines which of the gaseous nitrogen forms (illustrated on Figure 7-3) is produced. High quality carbon sources, such as methanol or acetic acid, allow conversion of the nitrogen to N_2 , while less degradable sources, such as sawdust or wood chips, generate nitric oxide (NO) or nitrous oxide (N_2O), both of which are powerful greenhouse gases. Denitrification is an energy intensive and slow process, so detention times of 2-3 days are required for optimal removal.

A BAM media for nitrogen reduction was developed by the University of Central Florida Stormwater Academy and is referred to as “Bold and Gold” media. A pilot test of this material was conducted by the Stormwater Academy for a rapid infiltration basin (RIB) in Deland, Florida used to infiltrate treated wastewater into groundwater to address concerns about rising nitrate levels in adjacent springs. The 1.68-acre infiltration basin was retrofitted with a 2 ft layer of Bold and Gold consisting of a mixture of clay, tire crumb, and sand (CTS) with a measured dry bulk density of 63 pounds/cubic foot and a porosity of 32% in a dry condition without compaction. The compacted density increased to about 90 pounds/cubic foot. The average nitrate inflow concentration to the RIB from reuse was 3.62 mg/l, similar to reuse values at Marco Island, which was reduced to 0.72 mg/l (-80%) after flowing through the media. Lower nitrate concentrations, similar to those in stormwater, were reduced to concentrations less than the MDL for the laboratory. The Bold and Gold media is manufactured in Apopka and the CTS product currently costs about \$250/cubic yard plus transportation.

Assuming an average swale width of 5 ft and a Bold and Gold layer of 1.5 ft, the media requirements would be 28 yd³ per 100 ft of swale. At a cost of \$300/ yd³ (including transportation) the media cost per 100 ft would be \$8,400. The media could be added during routine recontouring and maintenance or added as a stand-alone project.

7.3.1.3 Summary and Recommendations

The current grassed swale drainage systems at Marco Island are ideal for infiltration which reduces the overall runoff volume and provides removal of solids in runoff. During the field monitoring program, ERD observed areas where swales had become partially filled over time which caused runoff to extend into impervious areas where infiltration cannot occur, reducing opportunities for important removal and treatment processes.

ERD recommends that swales which no longer have the desired cross-section or exhibit poor infiltration be regraded to restore both hydraulic and water quality functions. These regrading projects provide excellent opportunities to incorporate both swale blocks and BAM media into the systems to enhance nitrogen removal. Based on the discussion above, ERD recommends that the proposed regrading and/or installation of swale blocks and/or BAM media proceed as resources are available. This type of project would likely qualify for a variety of State grants designated for improving water quality.

7.3.2 Inlet Systems

As discussed in Section 3.5, the City has installed 1,324 inlet basket inserts to stormwater inlets which includes about 71% of the total inlets within the City. Locations of the inlet basket inserts are indicated on Figure 3-6. Many of the inlets which were not retrofitted were not suitable for the inlet basket system due to side inflows which bypass the top inlet. A schematic of the inlet filter system is given on Figure 7-6. Each system consists of a hydrocarbon adsorption mat and a basket to collect and store solids and debris. Installation of the inlet baskets was initiated during 2006, and as of 2018, the City has purchased and installed 834 inlet baskets at a cost of \$731,557, with an additional 490 filter insert baskets purchased by private and public contracts at no direct cost to the City. The City received grant funding from the SFWMD in the amount of \$740,000 to cover the cost of the inlet baskets.

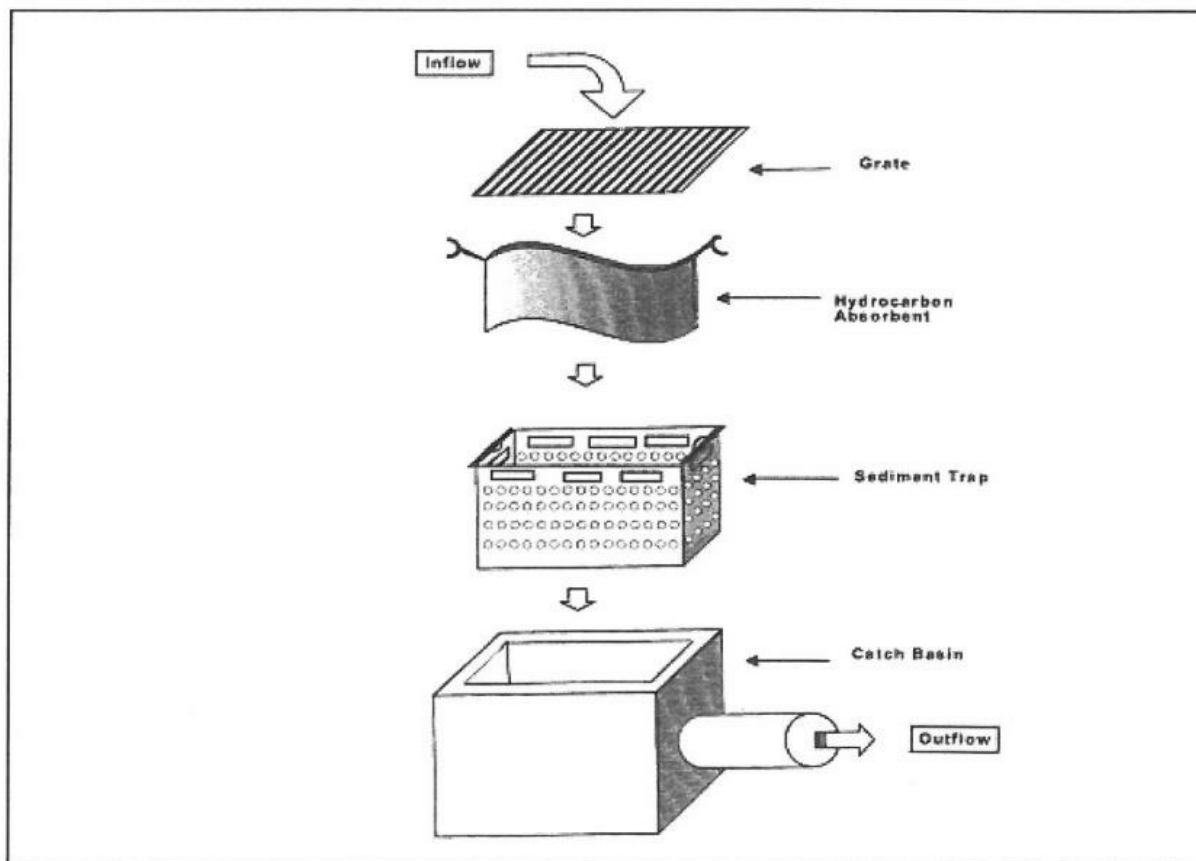

Figure 7-6. Schematic of Inlet Filter System Installed at Marco Island.

The inlet baskets are maintained on an annual basis by the City Public Works Department using the City-owned vacuum truck and current staff. Annual maintenance includes replacement of the absorbent mat and removal of collected debris in the baskets. During 2016, the City removed 13,599 lbs of debris from the 1,324 inlets, with 8,000 lbs removed during 2017 and 13,560 lbs removed during 2018. A photograph of solids collected from the units by City personnel is given on Figure 7-7.

An analysis of estimated removals for total nitrogen and total phosphorus by the inlet baskets is given in Table 7-6. Information is provided for the mass of solids removed each year in lbs and kg. Estimates of the percentage of total nitrogen and total phosphorus contained in the collected solids were obtained from the street sweeping study conducted by the Florida Stormwater Association (FSA) during 2012 which sampled street sweeping solids in municipalities throughout the State. Solids collected during this study had an average total nitrogen content of 0.105% and an average total phosphorus content of 0.0328%. Using these values, the units captured 16.7 kg of total nitrogen over the 3-year period for an annual average removal of 5.6 kg/yr for all units combined. Removal of total phosphorus was 5.2 kg over 3 years or 1.73 kg/yr. These values are a small fraction of the annual nutrient loading to area waterways.



Figure 7-7.

Solids Collected from Inlet Baskets by City Personnel.

TABLE 7-5

**ANALYSIS OF NUTRIENT LOAD REDUCTIONS
BY THE INLET BASKET SYSTEMS**

| YEAR | INLETS CLEANED | SOLIDS REMOVED | | TOTAL NITROGEN | | | TOTAL PHOSPHORUS | | |
|---------------|-------------------|-------------------|---------------|----------------|-------------|-------------|------------------|-------------|------------|
| | | lbs | kg | % by wt. | lbs | kg | % by wt. | lbs | kg |
| 2016 | 1,324 | 13,599 | 6,167 | 0.105 | 14.3 | 6.5 | 0.0328 | 4.5 | 2.0 |
| 2017 | 1,324 | 8,000 | 3,628 | 0.105 | 8.4 | 3.8 | 0.0328 | 2.6 | 1.2 |
| 2018 | 1,324 | 13,560 | 6,150 | 0.105 | 14.2 | 6.5 | 0.0328 | 4.4 | 2.0 |
| TOTAL: | 3,972 | 35,159 | 15,945 | | 36.9 | 16.7 | | 11.5 | 5.2 |
| | | Per Unit Values: | | | 0.0093 | 0.0042 | | 0.0029 | 0.0013 |

7.3.2.1 Summary and Recommendations

Even though the annual solids removal per individual inlet is small, and portions of the solids which could be collected by the inlets are already retained within the swale drainage system, the inlets provide a valuable function of removing not only sand and soil but also vegetation debris (shown on Figure 7-1) which would likely be worse without the inlets. Therefore, ERD recommends that the City retain the inlet system program and extend it to include suitable inlet locations not already included in the program, if any.

7.3.3 Stormwater Management

The City currently relies on water management criteria implemented by SFWMD for construction of stormwater management facilities for development. However, SFWMD provides an exemption from stormwater criteria for single-family homes, the dominant land use category on the island, and residential homes on the island do not have stormwater treatment systems. The existing roadside swale system provides significant pre-treatment of runoff through groundwater infiltration and removal of solids during low flow conditions, but during high flow conditions most of the runoff quickly passes through the swale system with little or no change in volume or concentration. The isotopic analyses indicate that runoff is impacted by both landscaping activities and reuse application, both of which have potentially high nutrient concentrations.

To reduce runoff impacts to waterways, it is recommended that the City consider adding stormwater management requirements for future homes or re-development. Rather than the standard surface ponds used in stormwater management, proven LID systems (such as rain gardens) can be easily incorporated into the landscape and not be recognizable as a stormwater treatment system. Some systems also incorporate a filter media to improve removal of nutrients. A schematic of a typical rain garden is provided in Figure 7-8. Rain gardens consist of a depressed landscaped area which is designed to capture and treat runoff from rooftops and pervious areas such as lawns. Runoff treatment occurs during infiltration through soil or BAM media installed in the bottom of the rain garden to reduce nutrient concentrations entering groundwater.



Figure 7-8. Typical Rain Garden Layout.

Rain gardens are a popular stormwater management technique, and design criteria for rain gardens are available from multiple sources. Photographs of rain gardens are provided in Figure 7-9. These systems would fit nicely into the existing landscaping themes currently used on Marco Island. The rain gardens should provide a volume capable of storing 1-inch of runoff over the contributing areas, including rooftops, which would achieve a removal efficiency of more than 85-90%.



Figure 7-9. Photographs of Rain Gardens.

7.3.3.1 Recommendations

ERD recommends that the City modify the City Development Code to require stormwater treatment for all new single-family homes and existing homes which have significant alterations. Although many options are available for the treatment systems, the most likely choice appears to be rain gardens which can be incorporated into landscaping. These systems would complement the existing Marco Island landscaping theme.

7.4 Seepage Management

7.4.1 Management Options

Management options for reducing loadings entering waterways through groundwater seepage involve reducing the volume or concentration of inflows to groundwater from runoff, irrigation water, and landscaping activities. Strategies for reducing impacts from seepage inflows include minimization of inputs from irrigation and fertilizer (discussed in a subsequent section) to interception and treatment of the groundwater prior to entering the waterways.

Options for reducing nitrogen loadings after entering groundwater are extremely limited and include ion exchange (which is prohibitively expensive) and denitrification, which appears to be the only practical option. Denitrification walls could be incorporated into the seawalls along the waterways to intercept nitrogen prior to entering the canal. This technique is gaining popularity in estuary areas to reduce nitrogen loadings from septic tanks and watershed inputs. As discussed in Section 5.1.3, seepage inflows contain more than adequate concentrations of DIN for denitrification to occur, and denitrification beds are a viable option in all waterways.

An example of a denitrification wall system is given in Figure 7-10. The bed consists of an 18- to 24-inch layer of BAM installed on the upstream side of a seawall so that the seepage must migrate through the bed before entering a waterway. The BAM layer could be identical to the material used in the swale systems. These beds could be added to existing seawall areas as a stand-alone project or incorporated into the seawalls during maintenance or replacement.

Figure 7-10.
Example of
Denitrification Bed
Incorporated into
Seawalls.

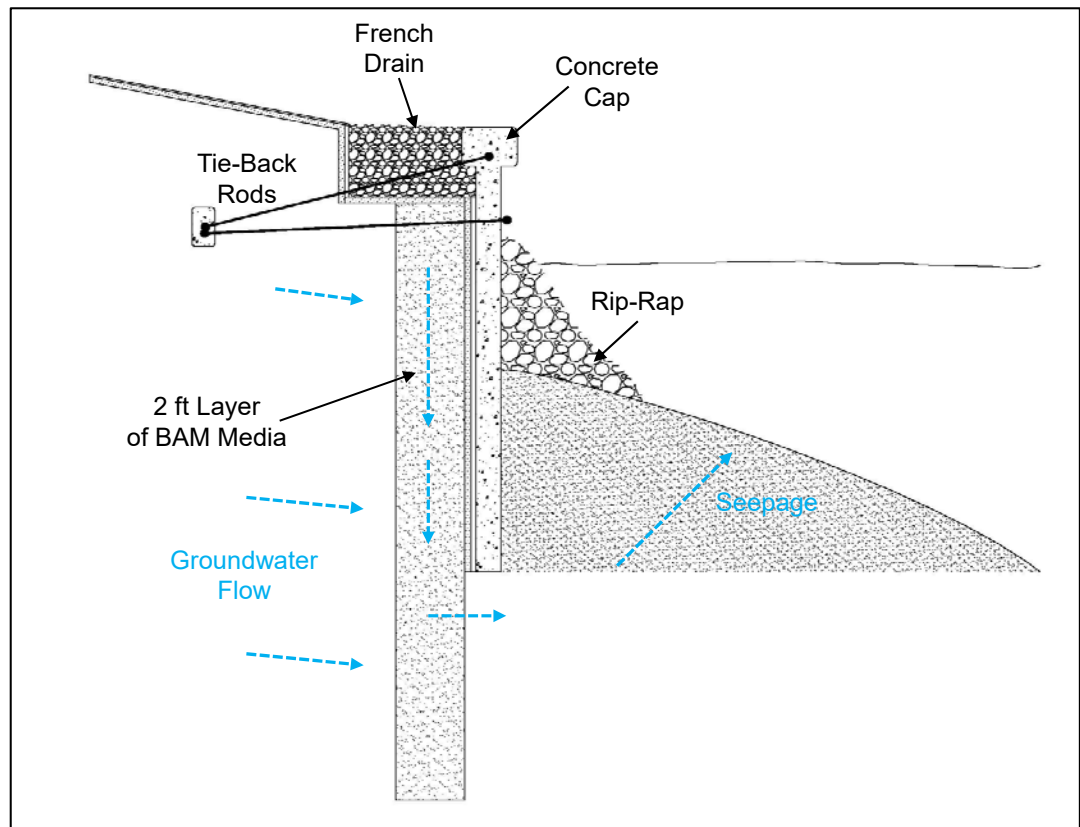

The BAM discussed in Section 7.3.1 would also be appropriate for interception of nitrogen loadings in groundwater. Assuming an average lot width (at seawall) of 100 ft, a media thickness of 2 ft, and a media wall height of 12 ft, the volume of media required per lot is 90 yd³. At a delivered cost of \$300/yd³, the media cost would be \$27,000/lot. Installation costs would vary considerably from lot to lot and will depend on the type of seawall, back yard landscaping or structures, access, and other issues. Installation would be less expensive if the media is incorporated into a repair or replacement project since excavation of all or parts of the seawall would already be included.

7.4.2 Summary and Recommendations

Due to the significance of seepage inflows as part of the overall nitrogen loadings to Marco Island waterways, ERD recommends that projects to install denitrification beds be implemented as soon as possible and as funding becomes available. Multiple grants are available from FDEP and other agencies which would fund all or portions of these projects. Installation of the recommended denitrification beds would be extremely intrusive to rear yards, and many of the waterfront homes have existing concrete surfaces or structures which extend to the seawall that would complicate installation. A pilot project is recommended for a limited area of homes to evaluate the installation process, potential issues, and effectiveness before extending the program to other areas. This appears to be the only available alternative for impacting the observed seepage loadings entering the waterways other than source control.

7.5 Reuse Irrigation

7.5.1 Overview of Issues

A discussion of the historical characteristics of reuse irrigation measured by the City was provided in Section 3.8, and characteristics of reuse water collected by ERD are provided in Section 5.1.2. Both analyses indicated extremely elevated nutrient concentrations which are often an order of magnitude greater in value than concentrations observed in stormwater runoff. Although isotopic signatures of reuse water were observed in both runoff and baseflow in virtually all sub-basins, overall nutrient concentrations in runoff samples were low in value, and reuse impacts appear to primarily be limited to groundwater.

As discussed in Section 3.8, reuse irrigation is applied at a rate of 0.56 inches/week on the golf courses and 0.88 inches to pervious surfaces in other public access areas. The Institute of Food and Agricultural Sciences (IFAS) at the University of Florida is the primary source for recommendations regarding application of fertilizers to turfgrass and agricultural areas in Florida. For decades IFAS generally ignored additional nutrients contributed by reuse irrigation, simply stating that the additional nutrients would be beneficial to the plants. However, in 2011 IFAS issued a publication titled “Urban Water Quality and Fertilizer Ordinances: Avoiding Unintended Consequences - A Review of the Scientific Literature” (IFAS Publication SL 283) which addresses the issue of nutrients in reuse irrigation:

“Reclaimed water is a nutrient solution (water plus nutrients) and should be managed to keep the solution in the root zone. Proper irrigation management with reclaimed water is required to prevent nitrogen leaching from over-application of reclaimed water. Rates of reclaimed water used in irrigation should be based primarily on the water needs of the turfgrass. Excessive irrigation with reclaimed water may result in leaching of the nitrogen contained in the reclaimed water as well as fertilizer-nitrogen previously applied to the turf grass. Irrigation with reclaimed water should be practiced with careful attention to avoid over-irrigation ...”.

The report concluded that to minimize reuse generated nutrient losses to groundwater, irrigation should be used only to supplement rainfall when evapotranspiration (ET) losses exceed rainfall.

7.5.2 Groundwater Impacts

An analysis was conducted to compare current reuse application rates on other public access areas with evapotranspiration losses for turfgrasses. A general hydrologic budget was developed for a typical turfgrass located in the public access areas on Marco Island which are irrigated with reuse water at a rate of 0.88 inches/week, as presented in Table 3-12. A summary of this analysis is given in Table 7-6. In this analysis, hydrologic inputs are included for average rainfall and applied reuse irrigation and compared with monthly evapotranspiration for turfgrass. Average monthly rainfall is obtained from the historical rainfall summary provided in Table 4-3, and irrigation inputs are assumed to be 3.52 inches/month (0.88 inches/week x 4 weeks/month), assuming that irrigation is applied evenly throughout the year. Evapotranspiration losses are based on monthly measurements taken in the South Florida area by the Florida Automated Weather Network using satellite imagery.

TABLE 7-6

HYDROLOGIC BUDGET FOR MARCO ISLAND TURFGRASS

| MONTH | AVERAGE RAINFALL (inches) | REUSE IRRIGATION INPUTS (inches) | EVAPO- TRANSPIRATION (inches) | DIFFERENCE (inches) |
|---------------|--|---|--|--------------------------------|
| January | 2.50 | 3.52 | 2.06 | +3.96 |
| February | 1.91 | 3.52 | 2.80 | +2.63 |
| March | 2.05 | 3.52 | 3.88 | +1.69 |
| April | 2.48 | 3.52 | 4.82 | +1.18 |
| May | 3.38 | 3.52 | 5.48 | +1.42 |
| June | 8.36 | 3.52 | 5.21 | +6.67 |
| July | 6.60 | 3.52 | 5.34 | +4.78 |
| August | 9.16 | 3.52 | 5.11 | +7.57 |
| September | 9.92 | 3.52 | 4.39 | +9.05 |
| October | 3.21 | 3.52 | 3.61 | +3.12 |
| November | 2.02 | 3.52 | 2.38 | +3.16 |
| December | 1.71 | 3.52 | 1.88 | +3.35 |
| TOTAL: | 53.30 | 42.24 | 46.95 | 48.58 |

Based on this analysis, normal monthly rainfall meets 100% of the evapotranspiration requirements of the turfgrass without supplemental irrigation during the months of January, June, July, August, and September, with supplemental irrigation requirements ranging from 0.17-2.34 inches for the remaining months. The current reuse irrigation application of 3.52 inches/month results in an exceedance of water application in excess of the turfgrass requirements ranging from 1.18-9.05 inches per month, with an annual surplus of 48.58 inches.

Over just the 398.96 acres of public access areas where reuse irrigation is applied, the excess water entering groundwater from excessive application of reuse is 1,615 ac-ft/yr, equivalent to 12% (526 million gallons or 1.44 MGD) of the total annual island annual seepage volume and a much higher percentage of seepage volume in the sub-basins where reuse irrigation is applied due to the large nitrogen concentrations in reuse compared with other sources. The volume of reuse applied in excess of the turfgrass requirements is 78% of the average annual reuse volume of 1.84 MGD from 2011-2020. In other words, approximately 78% of the applied reuse bypasses the turfgrass layer and enters groundwater with little change in nutrient content.

The primary issue with reuse irrigation is that there is a constant supply with a seasonally variable demand. The current reuse irrigation practice on Marco Island is simply a method of wastewater disposal with a constant amount applied each week regardless of the needs of the vegetation being irrigated. Other options are available for disposal of the treated wastewater which would not impact waterway loadings such as deep well injection and distribution to off-island customers.

ERD recommends that the City implement an educational program through utility bill inserts, signs, PSA adds, and other available means that explains that irrigation is only needed when rainfall is less than evapotranspiration. Constant application rates result in supplemental nutrient loadings which discharge to the island waterways through groundwater seepage.

7.5.3 Impacts to Fertilizer Requirements

The nutrients contained in reuse irrigation also supply necessary macro and micro elements to turfgrasses which can reduce or eliminate the need for supplemental fertilizer. The amount of nutrients supplied by reuse irrigation depends on the irrigation volume and the characteristics of the applied reuse. An analysis of nutrients generated from reuse irrigation at various weekly irrigation rates is given on Table 7-7. This analysis assumes a 1,000 ft² area irrigated at rates from 0.5-1.25 inches/week with the long-term reuse irrigation characteristics summarized in Table 3-14.

Recommendations for annual turfgrass fertilizer requirements are provided by the Florida Department of Agriculture and Consumer Services (FDACS). Annual fertilizer requirements vary depending on the type of turfgrass and location within the state. Typical values for St. Augustine grass in South Florida are given in Table 7-8. It is important to note that the FDACS recommendations are designed to provide the greenest appearance and most robust grasses, but many homeowners would be satisfied with the results provided by lower fertilization rates.

TABLE 7-7

ANNUAL MASS OF NITROGEN AND PHOSPHORUS SUPPLIED BY MARCO ISLAND REUSE IRRIGATION APPLIED AT VARIOUS WEEKLY RATES

| NUTRIENT | ANNUAL VOLUME (gallons/year) BY IRRIGATION RATE (inches/week) | | | | MEAN REUSE CONCENTRATION (mg/l) | NUTRIENT MASS (lb/1,000 ft ² -yr) BY REUSE IRRIGATION RATE ¹ (inches/week) | | | |
|------------|---|--------|--------|--------|---------------------------------------|---|------|------|------|
| | 0.5 | 0.75 | 1.0 | 1.25 | | 0.5 | 0.75 | 1.0 | 1.25 |
| Nitrogen | 16,207 | 24,310 | 32,413 | 40,517 | 8.72 | 1.18 | 1.77 | 2.36 | 2.95 |
| Phosphorus | 16,207 | 24,310 | 32,413 | 40,517 | 3.37 | 0.46 | 0.68 | 0.91 | 1.14 |

1. Assumes a 1,000 ft² irrigated area

TABLE 7-8

RECOMMENDED ANNUAL FERTILIZER APPLICATION RATES FOR SOUTH FLORIDA TURFGRASSES

| NUTRIENT | RECOMMENDED APPLICATION RATE ¹ (lbs/1000 ft ² -yr) |
|------------|--|
| Nitrogen | 4-6 (Assume 5) |
| Phosphorus | 0.5 (as P ₂ O ₅) or 0.16 (as P), if soil is phosphorus deficient |

1. FDACS. Urban Turf Fertilizer Rule for Home Lawn Fertilization, IFAS Publication #Enh 1089, Date: February 6, 2018.

A comparison of nutrients supplied by reuse irrigation and nutrient requirements for St. Augustine grass (the dominant turfgrass on Marco Island) grown in South Florida conditions is given in Table 7-9. The values provided in this table represent the percentage of annual fertilizer requirements provided by reuse irrigation at various application rates. Reuse irrigation supplied at Marco Island provides 24-59% of the annual nitrogen turfgrass requirements. At the average applied rate of 0.88 inches/week on common areas, the reuse supplies about 40% of the annual nitrogen requirements; and if fertilizers are applied, then the application rates could be reduced by 40%. The percentage of phosphorus requirements supplied by reuse irrigation is much larger, ranging from 288-713%, depending on the applied irrigation rate. Based on this analysis, the phosphorus supplied by reuse far exceeds the grass requirements, and the vast majority of applied phosphorus leaches past the root zone into groundwater, ultimately reaching the waterway system.

ERD recommends that the City implement an educational program to inform citizens about the level of nutrients in reuse water and inform both citizen and professional applicators to reduce the nitrogen application rates to lawns by the percentages listed in Table 7-9 based on weekly application rates.

TABLE 7-9

**PERCENTAGE OF ANNUAL ST. AUGUSTINE GRASS
FERTILIZATION REQUIREMENTS SUPPLIED BY
MARCO ISLAND REUSE IRRIGATION**

| NUTRIENT | ANNUAL NUTRIENT REQUIREMENT (%) SUPPLIED FROM REUSE IRRIGATION BY APPLICATION RATE (inches/week) | | | |
|------------|--|------|-----|------|
| | 0.5 | 0.75 | 1 | 1.25 |
| Nitrogen | 24 | 35 | 47 | 59 |
| Phosphorus | 280 | 420 | 569 | 713 |

7.5.4 Maintenance and Application Issues for Reuse Irrigation

In addition to indirect groundwater impacts, reuse irrigation also has significant direct impacts to stormwater loadings to receiving waters. Due to the order of magnitude difference in nutrient concentrations between runoff and reuse irrigation, only a small amount of undesired reuse overspray or discharge from broken or misdirected irrigation heads can increase loadings to waterways.

A comparison of potential loading impacts from runoff and reuse overspray is given in Table 7-10. Runoff loadings are calculated assuming a 0.25-acre pervious area with an annual runoff C-value of 0.086 which is the average C-value for Marco Island watersheds. Using the assumed annual rainfall of 53.3 inches and average field monitored runoff concentrations of 0.764 mg/l for nitrogen and 0.232 mg/l for total phosphorus, the annual runoff generated mass loadings of nitrogen and phosphorus from the 0.25-acre area are 0.090 kg/yr for total nitrogen and 0.027 kg/yr for total phosphorus. This analysis assumes 5% of the annual reuse irrigation volume is lost due to overspray or broken or misaligned spray heads. Loadings for reuse irrigation are based on irrigation of the 0.25-acre pervious surface at a rate of 0.75 inch/week at the average reuse concentrations of 8.72 mg/l for nitrogen and 3.37 mg/l for phosphorus, summarized in Table 3-14, resulting in annual overspray loadings of 0.058 kg/yr for nitrogen and 0.023 kg/yr for phosphorus.

Based on this analysis, the additional loading resulting from a routine 5% overspray of reuse irrigation is equivalent to 65% of the annual runoff nitrogen loading and 83% of the annual runoff phosphorus loading. An increase of overspray to just 8%, which is not an unlikely assumption, would increase the overspray loadings to values exceeding the runoff load. This loading is largely undocumented since the stormsewer flow rates associated with these volumes are too low to trigger sample collection using an automated sampler. A strong signature of manure and sewage was present in baseflow samples and overspray is likely the cause for this observation.

TABLE 7-10

IMPACTS FROM OVERSPRAY OF MARCO ISLAND REUSE IRRIGATION

| NUTRIENT | LOADING FROM RUNOFF | | LOADING FROM REUSE OVERSPRAY | | | |
|-------------------|-----------------------------------|---------------------|-----------------------------------|-------------------------------|------------------------------------|----------------------------|
| | Volume ¹ (gal/year) | Annual Load (kg) | Volume ² (gal/year) | Reuse Concentration (mg/l) | Annual Load from Overspray (kg) | Percent of Runoff Load (%) |
| Nitrogen (as N) | 31,115 | 0.090 | 35,393 | 8.72 | 0.058 | 65 |
| Phosphorus (as P) | 31,115 | 0.027 | 35,393 | 3.37 | 0.023 | 83 |

1. Based on a pervious area of 0.25-acre, annual rainfall of 53.3 inches, and runoff C-value of 0.086

2. Based on an irrigation area of 0.25-acres at rate of 0.75 in/week

During the field monitoring program, ERD observed multiple instances of application of reuse irrigation water which resulted in either overspray or direct runoff into stormsewer systems. Photographs of examples are given on Figure 7-11. Figure 7-11a was taken in Sub-basin 5 showing a City water truck using reuse water to irrigate the landscaped median, and water flowing onto the roadway surface is clearly visible. The photograph on Figure 7-11b was taken on April 29, 2020 at approximately midnight on Collier Blvd. During this event, much of the roadway surface was wet and irrigation water was visibly running along the gutters into the stormsewer system. Even if the excess irrigation water does not enter the stormsewer system, it dries on the roadway surface and the nutrients are available for transport with the next rain event.



a. Median irrigation with reuse water



b. Overspray of reuse irrigation along Collier Blvd.

Figure 7-11. Reuse Water Applications.

7.5.5 Golf Course Irrigation

The Marco Island golf course, also referred to as the Island Country Club, is a significant user of reuse water for on-site irrigation with a stated capacity of 0.450 MGD. According to the analysis presented in Section 3.8, the golf course areas are irrigated at a rate of approximately 0.56 inches per week. However, unlike reuse irrigation applied to public and common areas, reuse pumped to the golf course is stored in a surface pond prior to use, and irrigation water is pumped from the surface pond rather than direct use from the reuse distribution system.

Routine samples of reuse irrigation and golf course pond water used for irrigation were collected by ERD during the field monitoring program, with 24 samples of reuse and 13 samples of golf course pond water. A comparison of geomean characteristics of reuse and pond water is given in Table 7-11. The golf course pond has an outfall to tide, and reverse flow into the pond was observed on multiple occasions during high tide conditions.

TABLE 7-11

**COMPARISON OF GEOMEAN CHARACTERISTICS OF REUSE
AND GOLF COURSE POND WATER USED FOR IRRIGATION**

| PARAMETER | UNITS | REUSE | REUSE POND OUTFALL | GOLF COURSE POND REMOVAL (%) |
|---------------------|---------|-----------|-----------------------|------------------------------------|
| pH | s.u. | 7.36 | 7.49 | 2 |
| Alkalinity | mg/l | 99.1 | 134 | 35 |
| Conductivity | µmho/cm | 1,397 | 8,789 | 529 |
| NH ₃ -N | µg/l | 11 | 286 | 2419 |
| NO _x -N | µg/l | 3,263 | 9 | -99 |
| Dissolved Organic N | µg/l | 479 | 950 | 98 |
| Particulate N | µg/l | 150 | 361 | 140 |
| Total N | µg/l | 4,629 | 1,882 | -59 |
| SRP | µg/l | 2,300 | 137 | -94 |
| Dissolved Organic P | µg/l | 391 | 109 | -72 |
| Particulate P | µg/l | 121 | 68 | -44 |
| Total P | µg/l | 3,267 | 395 | -88 |
| Turbidity | NTU | 0.3 | 4.1 | 1,079 |
| Color | Pt-Co | 5 | 103 | 2,102 |
| TSS | mg/l | 0.3 | 8.8 | 2,965 |
| # of Samples | -- | 24 | 13 | |

Increases in alkalinity and conductivity were observed in the pond water compared with reuse irrigation, presumably due to the periodic influx of alkaline marine inflows. However, substantial reductions in measured concentrations of nitrogen and phosphorus were observed in the pond water from physical and biological removal processes common in wet pond systems. Concentrations of ammonia, dissolved organic nitrogen, and particulate nitrogen increased in the pond compared with reuse, but nitrate (which comprised the majority of nitrogen present) was reduced by 99%, with a reduction in total nitrogen of 59% and an average concentration of 1,882 µg/l. Substantial concentration reductions were observed for SRP, dissolved organic phosphorus, and particulate phosphorus, with an overall removal of 88% for total phosphorus and an average concentration of 395 µg/l.

The use of the storage pond provides an opportunity for nutrient removal prior to use as irrigation water. The resulting concentrations of total nitrogen and total phosphorus are similar to concentrations in runoff collected from residential communities outside of Marco Island and substantially reduces the potential impacts to groundwater from over-irrigation and unintended loadings from irrigation overspray. No significant differences were observed during the field monitoring program in characteristics of groundwater seepage collected in seepage meters located adjacent to the golf course, and the use of the storage pond may be largely responsible for the apparent lack of significant groundwater impacts.

Similar to the discussion provided in the previous section, irrigation on the golf course should only be applied as necessary to meet the monthly deficit between rainfall and evapotranspiration. A potential disadvantage of using a storage pond for reuse prior to irrigation is that the incoming flow is received at a relatively constant rate which is unrelated to potential irrigation needs. At the Marco Island golf course, pond water which is not used for irrigation is discharged to tide and becomes a direct loading source. There is currently no level recorder or flow measurement device which documents the amount of water discharged from the pond.

The use of storage ponds to pre-treat reuse irrigation prior to application has been used in other areas of Florida to address reuse impacts, and a similar regional system would be a benefit to Marco Island to reduce existing reuse impacts. However, a surface storage pond would require a multi-acre site which is likely not available on the island. One potential option could be an off-island storage pond, although this would require pumping the reuse water to the off-island pond and back to the island for use.

Golf courses in Florida generally use Bermudagrass due to the slow growth and resistance to repeated use. Recommendations for annual fertilizer requirements for Bermudagrass in South Florida is provided in Table 7-12, based on the FDACS recommendations discussed previously. The annual nitrogen application rate is 5-7 lbs/1000 ft² per year which is slightly greater than the recommendations for general turfgrasses such as St. Augustine.

TABLE 7-12**RECOMMENDED ANNUAL FERTILIZER APPLICATION RATES FOR BERMUDAGRASS IN SOUTH FLORIDA**

| NUTRIENT | RECOMMENDED APPLICATION RATE¹ (lbs/1000 ft²-yr) |
|-----------------|---|
| Nitrogen | 5-7 (Assume 6) |
| Phosphorus | 0.5 (as P ₂ O ₅) – if required based on soil test 0.16 (as P) |

1. FDACS. Urban Turf Fertilizer Rule for Home Lawn Fertilization, IFAS Publication #Enh 1089, Date: February 6, 2018.

A comparison of the percentage of nutrients supplied by reuse irrigation and Bermudagrass nutrient requirements is given in Table 7-13. The values provided in this table represent the percentage of annual fertilizer requirements provided by irrigation from the golf course pond at various application rates. Reuse irrigation obtained from the golf course pond provides 12-29% of the annual Bermudagrass nitrogen turfgrass requirements, depending on the weekly irrigation application rate. At the average applied rate of 0.56 inches/week at the golf course, the reuse supplies about 25% of the annual nitrogen requirements; and if fertilizers are applied, then the application rates could be reduced by 25%. Since soil phosphorus availability generally exceeds turfgrass requirements in Florida, any additional phosphorus application will increase loading to groundwater.

TABLE 7-13**PERCENTAGE OF ANNUAL BERMUDAGRASS FERTILIZATION REQUIREMENTS SUPPLIED BY GOLF COURSE REUSE IRRIGATION**

| NUTRIENT | ANNUAL NUTRIENT REQUIREMENT (%) SUPPLIED BY REUSE BY IRRIGATION RATE (inches/week) | | | |
|-----------------|---|-------------|----------|-------------|
| | 0.5 | 0.75 | 1 | 1.25 |
| Nitrogen | 12 | 17 | 23 | 29 |

An analysis was conducted to compare current reuse application rates on the golf course with evapotranspiration losses for Bermudagrass. A general hydrologic budget was developed for Bermudagrass located on the Marco Island golf course using the methodology previously described in Section 7.5.1, and the results of this analysis are summarized in Table 7-14. The monthly rainfall and supplemental irrigation of 0.56 in/week on the golf course causes exceedances of monthly evapotranspiration rates during 11 of the 12 months on an average basis, with a deficit of -0.10 inch during April. The surplus annual water depth of 33.22 inches from excess rainfall and reuse irrigation over the 230 acres irrigated on the golf course results in an annual surplus of 637 ac-ft (208 million gallons or 0.57 MGD) which enters groundwater, although at a much lower concentration than areas with direct reuse irrigation.

TABLE 7-14**HYDROLOGIC BUDGET FOR GOLF COURSE BERMUDAGRASS**

| MONTH | AVERAGE RAINFALL (inches) | IRRIGATION INPUTS (inches) | EVAPOTRANSPIRATION (inches) | DIFFERENCE (inches) |
|---------------|----------------------------------|-----------------------------------|------------------------------------|----------------------------|
| January | 2.50 | 2.24 | 2.06 | 2.68 |
| February | 1.91 | 2.24 | 2.80 | 1.35 |
| March | 2.05 | 2.24 | 3.88 | 0.41 |
| April | 2.48 | 2.24 | 4.82 | -0.10 |
| May | 3.38 | 2.24 | 5.48 | 0.14 |
| June | 8.36 | 2.24 | 5.21 | 5.39 |
| July | 6.60 | 2.24 | 5.34 | 3.50 |
| August | 9.16 | 2.24 | 5.11 | 6.29 |
| September | 9.92 | 2.24 | 4.39 | 7.77 |
| October | 3.21 | 2.24 | 3.61 | 1.84 |
| November | 2.02 | 2.24 | 2.38 | 188 |
| December | 1.71 | 2.24 | 1.88 | 2.07 |
| TOTAL: | 53.3 | 26.88 | 46.96 | 33.22 |

7.5.6 Summary and Recommendations

In summary, reuse irrigation is currently applied to common areas at rates which are well in excess of the evapotranspiration rates of turfgrasses, resulting in approximately 78% of the applied reuse water leaching past the root zone and entering groundwater. The amount of reuse irrigation applied to common areas, excluding golf courses, which enters groundwater is equal to 12% of the total annual groundwater seepage entering area waterways and, due to the disproportionately higher nitrogen concentrations in reuse, the annual fraction of nitrogen loadings from reuse to seepage inflows is even higher. ERD recommends that alternative disposal options for treated wastewater be evaluated, such as additional off-island customers, which would maintain the revenue stream from sale of reuse.

One method of reducing the nutrient content in reuse water is to use a storage pond where reuse is stored prior to use. ERD recommends that the City conduct an evaluation of this potential load reduction option. Although this option would be expensive, the cost must be compared with the potential load reductions from reuse which appears to be a significant source of waterway loadings.

Reuse irrigation to the golf course comes from an on-site storage pond where physical and biological processes substantially reduce nutrient concentrations and potential groundwater impacts. However, the golf course should modify the current irrigation schedule to only apply irrigation water to meet the evapotranspiration deficit instead of a fixed schedule, and nutrients supplied by reuse should be considered in fertilizer applications.

7.6 Improved Recirculation

7.6.1 Existing Conditions and Issues

An evaluation of the hydraulic function and flushing of the waterways was not part of the work efforts conducted by ERD. However, even without a thorough analysis, it is obvious that many areas have poor to non-existent flushing during tidal events. Both the historical water quality data collected by the City and the field monitoring conducted by ERD indicated higher levels of nutrients and chlorophyll-a in stagnant dead-end canals north and south of San Marco Rd. Differences in water quality and clarity between upstream and downstream portions of canals are also readily apparent on many aerial photographs of the island, with upstream stagnant areas characterized by a darker water column. These stagnant areas have little change in water quality during tidal cycles which allows nutrients to accumulate and fuel algal growth.

There appears to be little argument that enhanced recirculation and flushing would benefit water quality in the canals, particularly in upstream isolated and dead-end areas. According to Jason Tomassetti with the City of Marco Island Public Works Department, 24-inch culverts were installed between isolated canals during the original construction to encourage flushing and water exchange between canals. However, the specific locations and conditions of the culverts are not known, and many or all may have become fully or partially blocked with sediment and debris. A separate project should be undertaken to locate and clean the existing culverts, and the resulting water quality changes should be monitored over a 6- to 12-month period.

If the restored culverts do not provide noticeable water quality improvements, then other options should be considered to improve recirculation. One possible option is to install new culverts between canal sections. The most logical locations would be beneath San Marco Rd. to connect the northern and southern canal systems. Connection of the east and west canals does not appear to be feasible due to the long distances involved and existing development.

7.6.2 Recirculation Options

The most obvious option to improve recirculation in the canals is to install new, replacement, or supplemental culvert connections between areas of good and poor flushing. Locations of potential sites for installation of flushing culverts are indicated on Figure 7-12, with 3 locations for each of the west and east side systems. A potential location for an interconnection at Site 1 on Figure 7-12 is given on Figure 7-13. Both the northern and southern canals are quite stagnant, and an interconnection at the location indicated would allow water to freely exchange between the 2 and possibly introduce cleaner water from tidal sources. Most culverts would need to be installed by horizontal directional drilling (HDD), but if the open lots in the photo are still undeveloped, the culvert could possibly be installed by open cut excavation. Any piping placed in the ground would need to be able to physically support future development.



Figure 7-12. Proposed Area Options for Recirculation Improvements.

Options for an interconnection at Site 2 are shown on Figure 7-14. Multiple locations are available at this site which would satisfy the primary objectives of increasing circulation. Given the dense development, the culvert would need to be installed using horizontal drilling.



Figure 7-13.
Proposed Location
for Site 1
Interconnection.

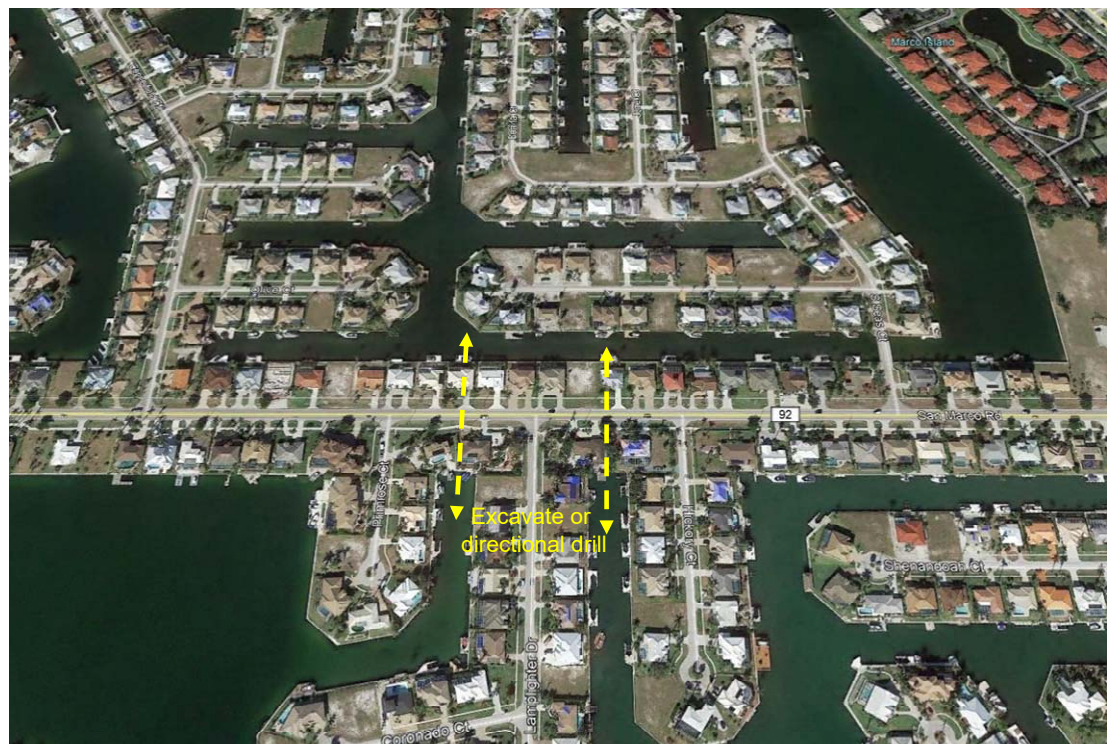

Figure 7-14.
Proposed
Location for
Site 2
Interconnection.

An option for interconnection Site 3 is shown on Figure 7-15, and this site is an important and promising location for interconnection. The southern segment has a relatively direct connection to tidal water, while the northern pathway is more complex, and interconnection of the two would likely be effective.

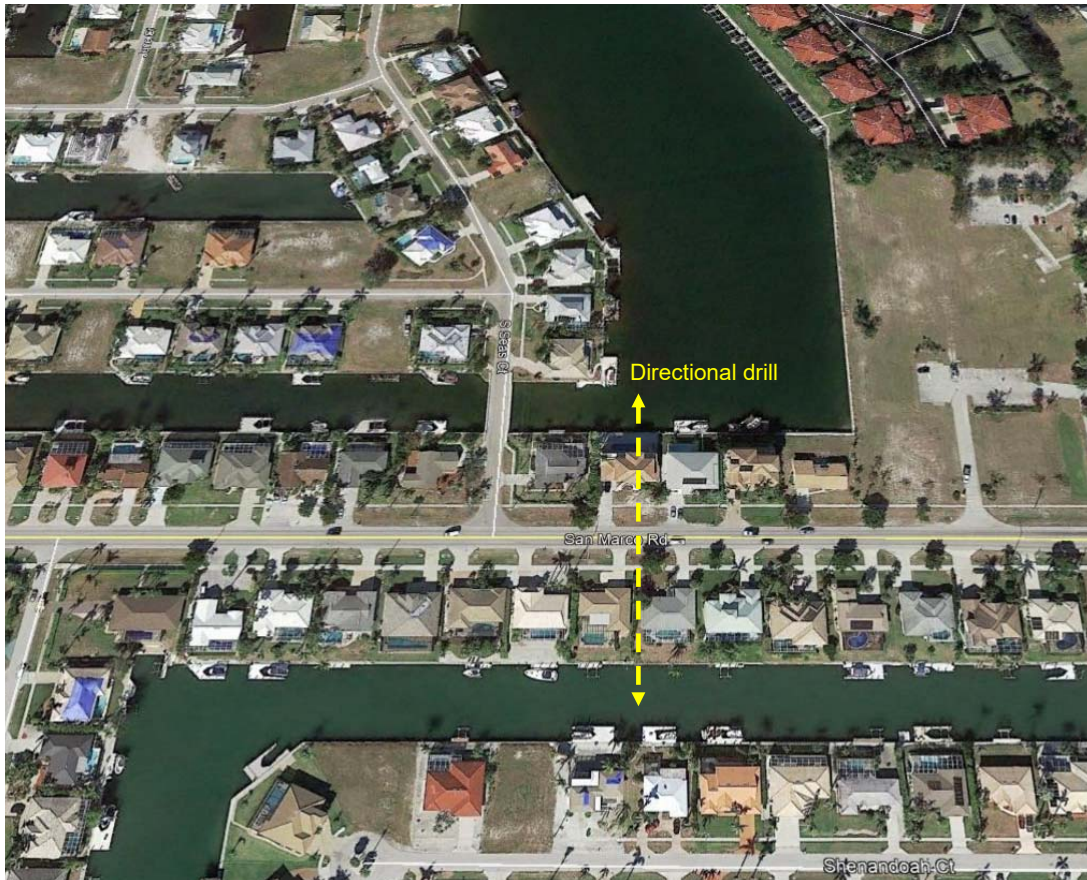

Figure 7-15.
Proposed Location
for Site 3
Interconnection.

Proposed interconnection Sites 4 and 5 are shown on Figure 7-16 and are similar in hydraulics to Site 3. Stagnant canal areas north of San Marco Road would be connected to southern canals which have an almost direct connection to tidal water. Proposed Site 6, shown on Figure 7-17, is also a site which would allow an almost direct tidal connection to tidal for the stagnant canal section.

Before any of these options can be further considered, a hydraulic study must be conducted to model the waterways and determine which combinations of interconnections, if any, would significantly improve water movement in the dead-end canals. The study should address required pipe sizes and installation costs.

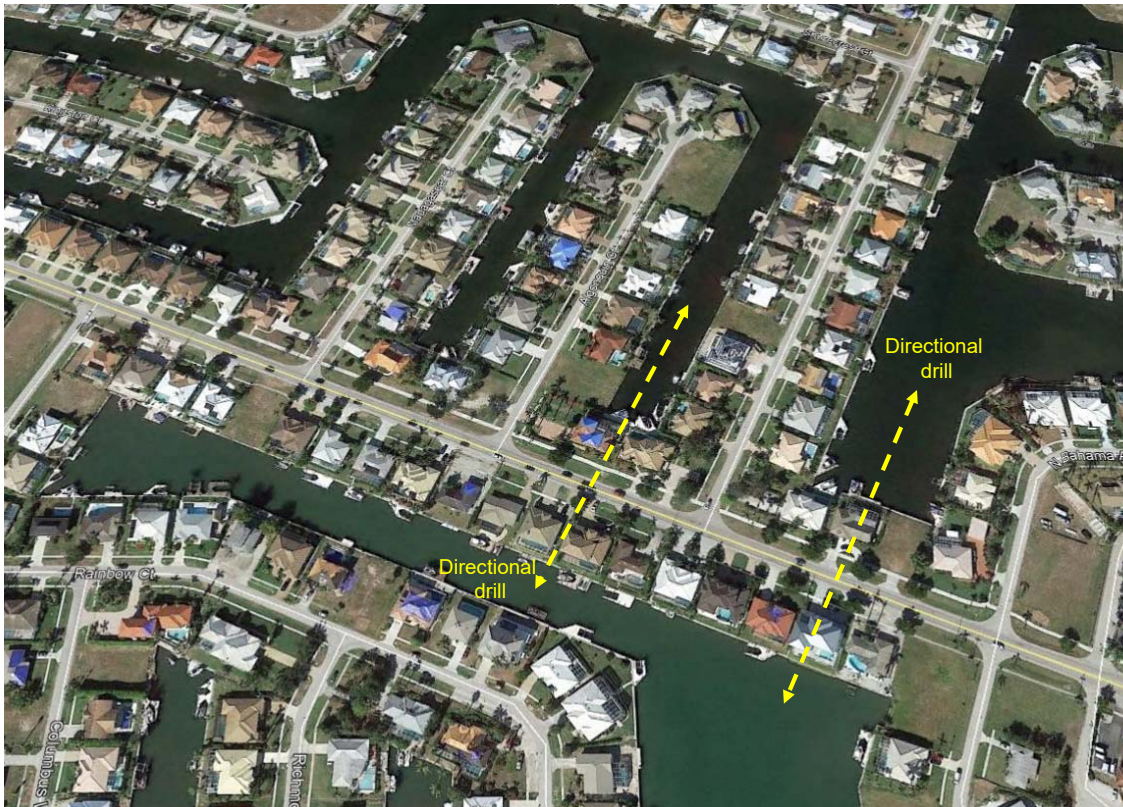

Figure 7-16.
Proposed
Location for
Sites 4 and 5
Interconnection.

Figure 7-17.
Proposed
Location for
Site 6
Interconnection.



Another potential option to improve flushing is to use a pumping system to convey water from stagnant areas to mixed areas, or vice versa. If the existing interconnecting culverts could be located, it may be possible to install a pump station in City right-of-way (ROW) or beneath the roadway which intercepts the buried culvert and moves large volumes of water from one side to the other. The feasibility of this option could be evaluated as part of the hydraulic study which could evaluate system options such as pump size, pumping rates, and operational periods.

A preliminary cost estimate for HDD at the locations shown on Figure 7-10 is given in Table 7-15. Separate costs are provided for pipe diameters ranging from 24-60 inches, depending on the size recommended in the hydraulic study. The typical distance between the northern and southern canal segments on Figure 7-10 is 350 ft. A typical cost for HDD is \$45/inch of pipe diameter per foot of length. Estimated installation costs for a single canal interconnection range from \$378,000- 945,000. However, these costs are based on land-based installations. There would be additional costs for isolation piling, dewatering, and other issues related to the water-based site conditions which could easily increase costs by 50% or more. However, grants may be available from the State that would cover all or portions of these costs.

TABLE 7-15

**ESTIMATED COSTS FOR HORIZONTAL DIRECTIONAL
DRILLING FOR CANAL INTERCONNECTIONS**

| PIPE SIZE (inches) | ESTIMATED INSTALLATION COST (\$/inch diameter/ft) | PIPE LENGTH (ft) | ESTIMATED COST (\$) |
|-------------------------------|--|-----------------------------|------------------------------------|
| 24 | 45 | 350 | 378,000 |
| 36 | 45 | 350 | 567,000 |
| 48 | 45 | 350 | 756,000 |
| 54 | 45 | 350 | 850,500 |
| 60 | 45 | 350 | 945,000 |

7.6.3 Recommendations

Based on the discussion and analysis provided in this section, ERD recommends that the City engage a qualified consultant and conduct a hydraulic study of the Marco Island waterways to evaluate current flushing in the canals and options for improving circulation.

7.7 Landscape Activities

7.7.1 Existing Conditions and Issues

ERD personnel routinely observe instances of improper landscape and lawn maintenance activities which include blowing lawn clippings, leaves, and other vegetation debris onto paved or roadway surfaces, as well as improper application of both granular and liquid fertilizers to impervious surfaces and roadways. When grass clippings and fertilizers are introduced onto impervious surfaces, they become available for mobilization by stormwater runoff during rain events, causing them to be deposited into the nearest waterbody during storm events. These types of lawn maintenance practices are needless and irresponsible activities which have the potential to significantly increase nutrient loadings to Marco Island waterbodies. At best, these activities occur as a result of lack of information and education; while at worst, they represent a disregard for water quality consequences in a misguided attempt to reduce labor time and costs.

During the field monitoring program at Marco Island, ERD observed only a few instances of maintenance personnel discharging grass clippings and vegetation debris onto paved surfaces. The number of instances is certainly less than we have observed in other areas which suggests that Marco Island residents and maintenance personnel are mostly aware of proper landscaping activities. No instances of personnel blowing grass clippings directly onto waterways were observed, but floating grass clippings and vegetation debris, similar to the photos shown on Figure 7-1, were commonly observed within the waterways, suggesting that direct discharges onto waterways do exist. A portion of this vegetation could have been blown by wind or fallen from vegetation directly into the water, but much of the observed vegetation was likely deposited intentionally.

7.7.2 Fertilizer Ordinance

On March 7, 2016, Marco Island enacted Ordinance No. 16-02 titled “Fertilizer Regulations” which regulates application of fertilizer to lawns and turf on the island. The Ordinance was codified in Chapter 18, Article III of the City Code, Sections 18-61 through 18-100. A copy of this Ordinance is included in Appendix I. The adopted Fertilizer Ordinance is based on the FDEP Model Ordinance for Florida-Friendly Fertilizer Use which is a very basic set of guidelines that are common sense to most people.

The Fertilizer Ordinance places restrictions on the timing and amount of fertilizer which can be applied in Marco Island, and a summary of restrictions follows:

- No fertilizer containing nitrogen and phosphorus may be applied during the rainy season from June 1-September 30 or when a heavy rain event is anticipated
- Fertilizers containing phosphorus are prohibited unless soil test shows deficiency. When a deficiency is verified, phosphorus fertilizer may not be applied at rates that exceed 0.25 lbs P₂O₅/1000 ft² per application and not to exceed 0.50 lbs P₂O₅/1000 ft² per year
- Fertilizers applied to turf or landscape plants must contain no less than 50% slow-release nitrogen

- Fertilizers shall not be applied more than 4 times during one calendar year to a single area
- No fertilizer or grass clippings shall be deposited on streets, driveways, or in storm drains
- No more than 4 pounds of nitrogen per 1000 ft² shall be applied to any single area during a calendar year
- Deflector shields must be in place when broadcast spreaders are used next to Fertilizer-Free zones or impervious surfaces; prior to the use of a deflector shield, the person must apply for an e-mail permit indicating the location and type of fertilizer to be used
- No fertilizer can be applied within 10 ft from waterways
- Commercial applicators must complete the 6-hour training program in Florida-Friendly Best Management Practices for Protection of Water Resources by the Green Industries offered through FDEP

Retail Businesses: Retail businesses that sell fertilizer must post a notice provided by Marco Island regarding the ordinance

Landscape Professional: Must be registered with the State and Marco Island. Must complete 6-hour training program to receive the Limited Commercial Fertilizer Applicator Certification (LCFAC) from the State. Certificate is valid for a period of 4 years.

Exemptions: Bona fide farm operations, other properties covered under the Florida Right to Farm Act, compost, athletic fields, and newly planted landscaping

Consequences of Noncompliance:

First violation: up to \$150 fine

Second and subsequent violations: not to exceed \$300 fine

The Marco Island Fertilizer Ordinance is similar in many ways to ordinances adopted by Sarasota County, Pinellas County, and the City of Tampa with one significant exception. Ordinances developed by Pinellas County and Tampa during 2010-2011 include a summer ban on both use and sales of lawn fertilizers rather than a voluntary program. Some municipalities have also banned the sale of fertilizers containing phosphorus altogether. To prevent other Florida communities from following this approach, the Florida Legislature enacted F.S. 576.181 in 2013, granting FDACS the exclusive authority to regulate the sale, composition, formulation, packaging, labeling, and distribution of fertilizer, which prevented local governments from enacting sales bans, although those in effect as of 2011 were grandfathered in.

Without a sales ban during restricted periods, educational signage at the point-of-sale is critically important to make consumers aware of local ordinances and the difference between compliant and non-compliant products. Most residents are probably unaware of the specifics of the Fertilizer Ordinance, if they are aware of it at all, and educational materials at the point of sale are an easy and inexpensive method of reaching the public. Summer-safe fertilizer products containing no nitrogen or phosphorus can be promoted as alternative lawn treatments during the restricted use period.

The first step in the educational process is for the City to seek voluntary assistance from local fertilizer retailers to add educational signage on shelving and to stock only ordinance-compliant products. This could be used as a marketing tool by retailers who could announce that they are capable of assisting citizens in selecting appropriate lawn care products. The City could provide the signage free of charge. Some cities have issued Proclamations or Resolutions designating one month as fertilizer awareness month to bring attention to the issue, and others use shrink wrap signage on City or County vehicles to provide information on issues such as fertilizer use and mosquito control. Public education has a large potential to improve fertilizer use and resulting impacts.

Recommendations

ERD makes the following recommendations regarding the Marco Island Fertilizer Ordinance and sale and use of fertilizers:

1. Amend the existing Fertilizer Ordinance to require properties with reuse irrigation to consider the loadings provided in the reuse. The information contained in Table 7-9, or similar tables, can be used to adjust fertilizer applications. This should apply to both citizens and professional landscapers. Educational information can be included in utility bills and notices.
2. The City should approach fertilizer retailers on Marco Island concerning educational signage and provide educational materials concerning responsible fertilizer use. Consider using City vehicles to advertise fertilizer issues.
3. Increase enforcement of the Fertilizer Ordinance, beginning with warnings and citations for repeat offenses. Professional landscaping companies with multiple violations should lose the ability to work on the Island.

However, in spite of the fertilizer ordinance, the isotope analyses suggest that landscaping activities and fertilizers are currently one of the primary sources of nitrogen entering groundwater. This implies that fertilizers are currently being applied at rates which exceed the uptake capacity of the vegetation. Since the vast majority of lawn maintenance on the island is conducted by professionals, the over-application most likely originates from professionals rather than citizens. The City should provide educational materials and/or seminars to landscape professionals regarding fertilizer use. Reducing fertilizer applications will save costs for fertilizers and reduce loadings to waterways.

7.7.3 Citizen Reporting

The City Fertilizer Ordinance is not specific on the process of reporting and identifying instances of violations of the provisions designed to safeguard water quality. It does not appear that any City department has specific responsibility for enforcing the Ordinance. Many counties have established a reporting center for citizens to report observations of personal activities that threaten water quality. Pollution activities, unless egregious, are not issues which are suitable for reporting to police through the 911 system. Residents could also call the Public Works Department or City Hall, but this requires additional effort to obtain the proper phone number which may discourage some citizens from reporting.

Orange, Seminole, and other Florida Counties have a “311” reporting center, similar to the “911” center, for reporting local non-emergency community incidents such as activities which threaten water quality. Local residents can use this service to anonymously report improper landscaping practices, particularly those involving fertilizer and discharge of vegetation debris into roadways or stormsewer systems. This type of system would be useful in identifying professional landscapers who conduct careless activities that threaten water quality. The City should consider implementing a similar system.

7.7.4 Recommendations

Deliberate discharge of fertilizers, yard wastes, leaves, and other vegetation debris onto paved surfaces, particularly roadways, is a needless practice since it is just as easy to blow fertilizer and yard waste back onto the landscaped surfaces as it is to discharge it onto the street or waterway. Although a Fertilizer Ordinance has been adopted and implemented in Marco Island, there appear to be some homeowners and lawn care professionals who are either unaware or ignore the Ordinance, particularly commercial landscaping companies, and evidence of excess application of nitrogen was observed in the isotope samples. The current Marco Island Ordinance does not appear to impose a significant hardship on landscape companies. When the fertilizer and yard waste is returned into the landscaped areas, it will decompose and provide additional sources of nutrients to the vegetation rather than the receiving waterbody.

In spite of the current Ordinance, instances of improper fertilizer application and discharge of vegetation debris onto paved surfaces still occur, although at a lower rate than observed in other parts of the State. Therefore, ERD recommends that Marco Island and designated agencies make enforcement of the Fertilizer Ordinance a priority and issue citations when violations are observed during routine job-related activities. Professional landscapers with multiple violations or citations should be prohibited from working on the island. The City should consider implementation of a dedicated reporting center for reporting of water quality violations.

7.8 Non-Structural Techniques

A number of non-structural techniques are also available which have the potential to reduce nutrient loadings entering waterbodies. Popular non-structural techniques include street sweeping, regulations which address landscape activities (addressed in Section 7.7), and source reduction programs which attempt to reduce pollutant accumulation within the watershed. These programs have a valid potential for improving the characteristics of stormwater runoff discharged to Marco Island waterways.

Source reduction programs have the potential to provide effective reductions in stormwater concentrations, particularly for nutrients and suspended solids. Source reduction techniques, such as street sweeping and public education, are capable of reducing loadings of pollutants entering receiving waterbodies by reducing pollutant accumulation within the watershed. If properly conducted, source reduction programs can be almost as effective as changes in stormwater regulations for reducing pollutant loadings to lakes. The two most common source reduction techniques are street sweeping and public education which are discussed in the following sections.

7.8.1 Street Sweeping

7.8.1.1 Introduction

Street sweeping is an effective best management practice (BMP) for reducing total suspended solids and associated pollutant wash-off from urban streets. Street sweeping is well suited to an urban environment where little land is available for installation of structural controls. Street sweeping can be extremely effective in commercial business districts, industrial sites, and intensely developed areas in close proximity to receiving waters.

Street sweeping involves the use of machines which basically pick-up contaminants from the street surface and deposit them in a self-contained bin or hopper. Mechanical sweepers are the most commonly used sweeping devices and consist of a series of brooms which rotate at high speeds, forcing debris from the street and gutter into a collection hopper. Water is often sprayed on the surface for dust control during the sweeping process. The effectiveness of mechanical sweepers is a function of a number of factors, including: (1) particle size distribution of accumulated surface contaminants; (2) sweeping frequency; (3) number of passes during each sweeping event; (4) equipment speed; and (5) pavement conditions. Unfortunately, mechanical sweepers perform relatively poorly for collection of particle sizes <100 microns which are commonly associated with total phosphorus loadings in stormwater runoff.

Over the past decade, improvements have been made to street sweeping devices which substantially enhance the performance efficiency. Vacuum-type sweepers, which literally vacuum the roadway surface, have become increasingly more popular, particularly for parking lots and residential roadways. The overall efficiency of vacuum-type sweepers is generally higher than that of mechanical cleaners, especially for particles larger than 3 mm. Estimated efficiencies of mechanical and vacuum-assisted sweepers are summarized in Table 7-16 based upon information provided by Young, et al. (1996). Mechanical sweepers can provide approximately 40% removal of phosphorus in roadway dust and debris, while vacuum-assisted sweepers can provide removals up to 74%. Recent studies in Hamilton County, Ohio indicated a significant reduction in runoff concentrations of nutrients after implementation of a vacuum sweeper program in residential areas.

TABLE 7-16
EFFICIENCIES OF MECHANICAL
(BROOM) AND VACUUM-ASSISTED SWEEPERS

| CONSTITUENT | MECHANICAL SWEEPER EFFICIENCY (%) | VACUUM-ASSISTED SWEEPER EFFICIENCY (%) |
|------------------|---|--|
| Total Solids | 55 | 93 |
| Total Phosphorus | 40 | 74 |
| Total Nitrogen | 42 | 77 |
| COD | 31 | 63 |
| BOD | 43 | 77 |
| Lead | 35 | 76 |

SOURCE: Young, et al. (1996)

A USGS-funded study performed by Breault, et al. (2005) conducted a side-by-side comparison of mechanical and vacuum-type sweepers in New Bedford, Massachusetts. A summary of the results of the street sweeper efficiency experiments is given on Table 7-17. The mechanical sweeper obtained weighted removal efficiencies of 31% and 20% in the two duplicate experiments compared with 60-92% using the vacuum sweeper. The study concluded that the vacuum sweeper efficiency was consistently greater than that of the mechanical sweeper, with the vacuum sweeper at least 1.6 times, and as much as 10 times, more efficient than the mechanical sweeper for all particle sizes. However, even though the vacuum sweeper exhibited substantially higher removal efficiencies, particularly for smaller diameter particles often associated with elevated nutrient concentrations, the mechanical sweepers still resulted in measurable removal efficiencies for all particle sizes encountered on roadway surfaces.

The efficiency of street sweepers is highly dependent upon the sweeping interval. To achieve a 30% annual removal of street dirt, the sweeping interval should be less than two times the average interval between storms. Since the average interval between storms in the South Florida area is approximately three days, a sweeping frequency of once every six days is necessary to achieve a 30% removal of street dirt. To achieve a 50% annual removal, sweeping must occur at least once between storm events. In the South Florida area, a 50% removal would require street sweeping to occur approximately once every three days.

Street sweeping activities can be particularly effective during periods of high leaf fall by removing solid leaf material and the associated nutrient loadings from roadside areas where they can easily become transported by stormwater flow. Previous research by ERD has indicated that leaves release large quantities of both nitrogen and phosphorus into surface water within 24-48 hours after becoming saturated in an aquatic environment. Loadings to waterbodies from leaf fall are often the most significant loadings to receiving waters during the fall and winter months.

Capital costs for street sweepers range from approximately \$70,000-150,000, with the lower end of the range associated with mechanical street sweepers and the higher end of the range associated with vacuum-type sweepers. The useful life span is typically 4-8 years, with an operating cost of approximately \$70/hour.

TABLE 7-17

**RESULTS OF STREET SWEEPER EFFICIENCY EXPERIMENTS
WITH A PELICAN SERIES P MECHANICAL SWEEPER AND A
JOHNSTON 605 SERIES VACUUM SWEEPER, BY PARTICLE SIZE
(Source: Breault, et al., 2005)**

| PARTICLE SIZE | SWEEPER EFFICIENCIES (%) | | | |
|-----------------------------|--------------------------|---------------|---------------|---------------|
| | MECHANICAL | | VACUUM | |
| | Experiment 1a | Experiment 1b | Experiment 1a | Experiment 1b |
| Gravel ¹ | 38 | 31 | 86 | 94 |
| Coarse Sand ² | 40 | 18 | 62 | 93 |
| Fine Sand ³ | 9 | 11 | 38 | 75 |
| Very Fine Sand ⁴ | 9 | 10 | 31 | 93 |
| Silt and Clay ⁵ | 13 | 13 | 39 | 81 |
| Weighted Average: | 31 | 20 | 60 | 92 |

1. Gravel: Larger than 2.0 mm
2. Coarse Sand: Smaller than 2.0 mm, larger than or equal to 250 μm
3. Fine Sand: Smaller than 250 μm , larger than or equal to 125 μm
4. Very Fine Sand: Smaller than 125 μm , larger than or equal to 63 μm
5. Silt and Clay: Smaller than 63 μm

7.8.1.2 Current City Program

According to the Public Works Department, Marco Island currently conducts limited street sweeping of intersections on Collier Blvd, approximately 8-9 curb miles, once each month. The sweeping is conducted by a local sub-contractor, since the City does not currently own a sweeper. Recently, the City Council approved purchase of a regenerative air sweeper which is a huge improvement from standard brush sweepers used in many cities. Regenerative air sweepers use a strong forced air flow to mobilize fine particles from the pavement surface which are vacuumed up by the sweeper.

The usefulness of a particular sweeper type is determined by the typical roadway section. Standard mechanical brush sweepers require a curb and gutter system for proper operation, while regenerative air and vacuum type sweepers can operate on any style roadway, including roads without defined curb and gutter systems which exist throughout much of Marco Island. The current swale drainage system provides an opportunity for particulate matter entrained by runoff to settle and accumulate prior to entering the stormsewer system. Many of these larger particles would be removed by a mechanical sweeper which could lead some to conclude that street sweeping is not necessary in areas with swale drainage. However, some of the fine particulate matter on roadway surfaces releases nutrients rapidly during rain events, and these soluble nutrients are not significantly removed in the swale system, so a street sweeping program which relies on either regenerative air or vacuum technology could reduce runoff loadings even with the present swale system.

7.8.1.3 Recommendations

ERD concurs with the efforts by the Public Works Department to purchase a City sweeper and implement an independent street sweeping program. Given the type of sweeper purchase proposed, we recommend that the City include as many streets as possible in the sweeping program, not just roads with curb and gutter systems. Although the load reduction is difficult to quantify, the effort should measurably reduce nutrient concentrations in runoff throughout the island.

7.8.2 Public Education

Public education is one of the most important nonpoint source controls which can be used in a watershed. Many residents appear to be unaware of the direct link between watershed activities and the water quality in adjacent waterbodies. The more a resident or business owner understands the relationship between nonpoint source loadings and receiving water quality, the more that person may be willing to implement source controls.

Several national studies have indicated that it is an extremely worthwhile and cost-effective activity to periodically remind property owners of the potential for water quality degradation which can occur due to misapplication of fertilizers and pesticides. Periodic information pamphlets can be distributed by hand or enclosed with water and sewer bills which will reach virtually all residents within the watershed. These educational brochures should emphasize the fact that taxpayer funds are currently being utilized to treat nonpoint source water pollution, and the homeowners have the opportunity to reduce this tax burden by modifying their daily activities. A comprehensive public education program should concentrate, at a minimum, on the following topics:

1. Relationship between land use, stormwater runoff, and pollutants
2. Functions of stormwater treatment systems
3. How to reduce stormwater runoff volume
4. Impacts of water fowl and pets on runoff characteristics and surface water quality
5. County stormwater program goals and regulations
6. Responsible use of fertilizer, pesticides, and herbicides
7. Elimination of illicit connections to the stormwater system
8. Controlling erosion and turbidity
9. Proper operation and maintenance of stormwater systems

The public education program can be implemented in a variety of ways, including homeowner and business seminars, newsletters, performing special projects with local schools (elementary, middle, and high schools), Earth Day celebrations, brochures, and special signage at stormwater treatment construction sites. Many people do not realize that stormsewers eventually drain to area lakes. Many cities and counties in Florida have implemented a signage program which places a small engraved plaque on each stormsewer inlet indicating "Do Not Dump, Drains to Waterway". ERD recommends that Marco Island implement an aggressive public education program which incorporates all of the elements discussed previously.

Anticipated load reductions for implementation of public education programs are difficult to predict and depend highly upon the degree of implementation by the homeowners within the basin. The impacts of public education programs also depend, to a large extent, on the degree to which water quality within the Marco Island waterways is currently being impacted by homeowner activities. Several regional and national studies are currently being performed which will attempt to document the pollutant removal effectiveness of public education programs.

7.8.2.1 Recommendations

Based on the potential significance of public education programs for reducing nutrient loadings to waterbodies, it is recommended that public education programs be initiated for Marco Island residents. This program should include public meetings, literature, and interaction with residents. The City should develop pamphlets and brochures which address issues related to water quality management and provide information on ways to reduce homeowner impacts to waterbodies.

7.8.3 Stormwater Utility

Given the central water-based theme of the island, on-going concerns from residents about water quality, and the Impaired status of the waterways, it was somewhat surprising to learn that there is no dedicated funding source or Stormwater Utility to address stormwater and water quality issues. A Stormwater Utility is a funding mechanism imposed on each parcel of land within the Utility boundary, such as a city or county. The Stormwater Utility imposes an annual non-ad valorem fee which is imposed on a parcel basis. Properties that have existing permitted stormwater management facilities generally have their fee reduced or pro-rated. Rates charged by Stormwater utilities throughout Florida are highly variable and are based on the needs of each community. The fees can be used to implement programs and projects to reduce pollutant loadings to waterways.

ERD strongly recommends that the City consider implementing a Stormwater Utility to provide a dedicated and constant funding source for potential water quality improvement projects. Many State-funded grants for water quality improvement projects are available only to communities that have Stormwater Utilities, and implementation of a Utility would provide a wide range of funding opportunities.

7.8.4 Water Quality Monitoring Program

After thoroughly reviewing the historical water quality data and monitoring protocol for the Marco Island waterways, ERD offers the following recommendations to improve the quality and usefulness of the monitoring program. The current monthly monitoring efforts provide an excellent basis for a program that is capable of generating a large amount of useful data, and ERD strongly recommends that the monthly monitoring program continue. However, the program could be enhanced by implementing the following recommendations:

1. Conduct vertical profiles of pH, conductivity, temperature, dissolved oxygen, and ORP at each site during each monitoring event. This only adds about 10-15 minutes per site and provides a wealth of information about the health of the waterbodies and potential sources impacting water quality. In many instances, the information gathered through vertical profiles is more useful than lab analyses on collected samples.
2. Report all nutrients in units of $\mu\text{g/l}$ (ppb) which generates integer values rather than decimals. This is an excellent common sense tool to improve the interpretative value of the data and avoid decimal errors which often occur when using units of mg/l. ERD converted all historical and current nutrient data to $\mu\text{g/l}$ for purposes of this project.
3. The current method of determining total nitrogen concentrations in the water samples is to measure TKN and add NO_x ($\text{TN} = \text{TKN} + \text{NO}_x$), but the resulting calculation for TN is impacted by the inherent inaccuracies in both the TKN and NO_x methods. TKN is a wastewater parameter which measures the combination of ammonia and organic nitrogen, while providing no specific information about either parameter, and is not well suited for nutrient concentrations commonly observed in surface water samples. Versions of the TKN test generate highly toxic mercury waste. The TKN test is not highly accurate and the current method of determining TN may result in artificially elevated TN values which could indicate an impairment when none is present. TKN provides information on a portion of the TN present that is used to calculate TN, so why measure part of something when the total can be measured directly and more accurately. A more accurate direct method of determining TN is a direct measurement method (SM-22, Method 4500 N.C) that allows simultaneous determination of TN and TP at extremely low detection limits of $3 \mu\text{g/l}$ for TN and $2 \mu\text{g/l}$ for TP. ERD has been using this method for over 25 years, and this method is also used by the LakeWatch program.
4. Contract with a qualified water quality consultant to conduct annual reviews of collected water quality data and generate general statistics and trend analyses to confirm improving or declining water quality data.

The existing Impaired designation for Marco Island waterways will eventually lead to a TMDL developed for the waterways by FDEP or approval of a 4e Plan which allows the City to control the restoration efforts. Throughout this process the City should maintain an independent evaluation of waterway water quality to provide documentation of improving water quality and to confirm data collected by state agencies and resulting conclusions. ERD strongly recommends that the City continue the existing monthly water quality monitoring program using a qualified environmental consulting firm and laboratory.

7.9 Regulatory Issues

As discussed in Section 2, the waterways surrounding Marco Island are on the FDEP Verified List of Impaired Waters with nitrogen as the causative agent. FDEP reviews available water quality for waterbodies on a 5-year rotating cycle. The data are compared with applicable water quality standards, and waterbodies which fail to meet applicable water quality criteria are listed as Impaired. Once a waterbody is placed on the Impaired Waters list, FDEP must conduct an evaluation of pollutant sources, typically using existing available data. Sources of the impaired parameter are calculated, FDEP assigns percentage load reduction goals to achieve water quality standards, and this evaluation is referred to as the Total Maximum Daily Load (TMDL) which outlines the restoration efforts. Under this program FDEP directs the sources to be reduced and the percentage reductions required.

As an alternative, FDEP has recently implemented an alternative assessment category referred to as 4e, defined to as:

“Waterbody indicates non-attainment of water quality standards and pollution control mechanisms or restoration activities are in progress or planned to address non-attainment of water quality standards, but the Department does not have enough information to fully evaluate whether proposed pollution mechanisms will result in attainment of water quality standards.”

This category allows the responsible city or county to develop an independent evaluation of sources and sinks for the Impaired Water and a water quality management plan to achieve load reductions and improve water quality. FDEP reviews water quality every 5 years, and as long as measurable improvements in water quality have been documented, the 4e designation will remain in effect and the city or county will control the improvements rather than FDEP.

This current evaluation contains more than sufficient information regarding loading sources and potential water quality improvement projects to satisfy the requirements for submittal as a 4e designation proposal. This report would be attached to the appropriate paperwork and submitted to FDEP for review. Since the Marco Island waterways have been designated as Impaired, the “do nothing” alternative is no longer an option, and water quality improvement projects must be implemented. The City must simply decide if it or FDEP controls the process.

Recommendations

ERD strongly recommends that the City pursue a 4e assessment category with FDEP. This designation will allow the City to control the restoration process rather than FDEP.

7.10 Summary of Recommended Management Options

Nutrient loadings to Marco Island waterways originate from a variety of sources, including sediment nutrient recycling, groundwater seepage, stormwater runoff, reuse irrigation, and bulk precipitation. A discussion of each of these inputs was provided in previous sections.

The largest annual nutrient loading to the waterways originates from internal recycling. Given the large cost for sediment removal and lack of research on effects of alum and other sediment treatments in marine environments, the only feasible management option is to improve water quality within the waterways through other mechanisms, such as stormwater management, and create a well-mixed and aerobic water column in all areas. Sediment nutrient release occurs at a faster rate when lower portions of the water column become anoxic, and this release can be minimized, but not eliminated, by maintaining aerobic conditions throughout the water column in all areas.

Direct stormwater runoff contributes a small portion of the annual loadings to waterways since virtually all runoff is infiltrated into groundwater through the highly permeable soils. Options were discussed for installation of swale blocks to increase runoff retention, and installation of a denitrification bed beneath existing swales which should be implemented during routine maintenance activities. Continuation of the existing system of inlet filter systems is also recommended.

Nutrient loadings from groundwater seepage constitute the second largest source of nitrogen to the waterways. This inflow reflects the combined inputs from direct rainfall, infiltrated runoff, irrigation water, and excess fertilizer applications. An option is presented for a denitrification wall to intercept the seepage and convert soluble nitrogen to a gaseous form. The denitrification option should be implemented to existing seawalls during replacement or repair projects, and incorporated into seawalls for all new development.

Reuse irrigation is currently being applied at a rate which exceeds the ability of turfgrasses to provide uptake of the water and nutrients which results in a large amount of the reuse leaching past the root zone into groundwater. The volume of currently applied reuse irrigation which exceeds the evapotranspiration requirements of the vegetation is 12% of the total annual seepage volume entering waterways and a much larger percentage of the annual mass loading. On an average basis, approximately 78% of the applied reuse irrigation bypasses the root zone and enters groundwater at elevated concentrations. Alternative methods of reuse disposal should be evaluated. The reuse irrigation system should also be inspected routinely to identify areas of overspray or broken irrigation heads. An educational program should be developed to inform residents about nutrient loadings in reuse and potential water quality impacts from excessive use.

Reuse irrigation is also used on the golf course, but the water is stored in a surface pond prior to application. Nutrient reduction occurs within the pond which reduces the nutrient loading to concentrations similar to urban runoff in other parts of Florida which reduces potential groundwater impacts. However, at the irrigation rates indicated by annual reuse summary forms provided to FDEP, the irrigation rates also exceed evapotranspiration requirements, although not to the extent observed by reuse application in other public areas, and irrigation reduction should be considered to meet evapotranspiration requirements. Nutrient loadings from reuse should be considered in fertilizer applications.

Both historical and current data collected by ERD indicate areas of dead-end canals with poor water quality resulting from lack of tidal flushing. These areas are easily identified on aerial photographs. General options are provided for improving recirculation by interconnecting canal sections on the north and south sides of San Marco Rd. Existing culverts, if present, should be located and cleaned, and the results should be monitored. If the culverts do not exist or do not provide sufficient recirculation, then additional culverts should be installed. A hydraulic study is recommended to identify optimum locations for additional interconnections.

Street sweeping is a low-cost alternative for reducing pollutants entrained in runoff. A limited street sweeping program is currently conducted by the City by a private contractor, with sweeping conducted only in intersections and along Collier Blvd. The City has approved purchase of a regenerative air sweeper in the 2022 budget, and the City should use this to increase sweeping to all roadways in Marco Island.

The Fertilizer Ordinance adopted in 2016 appears to contain many of the necessary elements to minimize water quality impacts from fertilizer applications, and fines are proposed for violations of the Ordinance. However, there are currently no personnel assigned to monitor infractions. Enhanced enforcement of this Ordinance is recommended, with repeat offenders losing the right to perform services on the island. The City should develop a voluntary educational program with local fertilizer retailers to inform residents of the fertilizer summer ban.

Public education is a powerful tool to inform residents about the link between watershed activities and water pollution in the waterways. Opportunities, such as pamphlets, billing inserts, billboards, and public meetings, should be used to educate residents.

The City currently has no dedicated funding source for water quality improvement projects other than general revenues. Adoption of a Stormwater Utility is recommended to provide additional funding sources. A Stormwater Utility is often required by FDEP or local governments to qualify for certain funding grants, and the cost of the Utility could easily be recovered several times over through these grants.

Marco Island waterways have been designated as Impaired by FDEP, and implementation of a TMDL will be initiated within the next 5-10 years. However, FDEP has developed an alternative assessment category (designated as 4e) which allows the responsible entity to conduct an independent evaluation of nutrient sources and management options. ERD recommends that the City pursue this designation to maintain control of the restoration process.

The current monthly water quality monitoring program in the Marco Island waterways generates a large amount of useful data and should be continued. Water quality data will become even more important in the future as water quality improvement projects are initiated. Recommendations are provided for enhancing the existing program.

Overall, a large number of factors impact water quality in Marco Island waterways, and groundwater seepage is a significant loading source. The two most significant nitrogen loadings to groundwater are reuse irrigation and over-fertilization. Reductions in fertilizer loadings can be achieved through education of both citizens and professionals. This is a low-cost activity for the City which could have a large return in reducing loadings. Reuse impacts can be reduced by reducing the current application rates and finding alternative customers or disposal methods which is also a low-cost option. Emphasis on reuse and fertilizers could provide measurable water quality improvements at low costs.

A summary of recommended water quality management options for Marco Island is given in Table 7-18. It is recommended that the management options be implemented as funding sources and opportunities become available.

TABLE 7-18

RECOMMENDED MANAGEMENT OPTIONS FOR MARCO ISLAND

| ISSUE | RECOMMENDATION | COST (\$) |
|--------------------------------------|--|------------------------------|
| Internal Sediment Nutrient Recycling | Sediment removal is prohibitively expensive; most feasible option is to reduce the rate of nutrient release by improving water quality by managing other sources to maintain aerobic conditions in waterways | 189,820,000 |
| Stormwater Management | a. Install shallow swale blocks in swales to increase retention of runoff | \$300/swale block |
| | b. Install denitrification beds beneath existing swales during maintenance or regrading projects. | 8,400/100 ft for media |
| | c. Continue current inlet filter system to assist in removing solids and debris from waterways | Included in current program |
| | d. Consider stormwater management requirements for single-family homes such as rain gardens | Low |
| Seepage Management | Install denitrification beds adjacent to seawalls during repair or replacement; add to new seawalls during construction | 27,000 per 100 ft of seawall |
| Reuse Irrigation | a. Evaluate alternative methods for reuse disposal which do not increase loadings to groundwater or surface water | Unknown |
| | b. Conduct routine inspection and repair of the reuse irrigation system to prevent areas of overspray | |
| | c. Provide an educational program to inform residents about nutrients contained in reuse irrigation and potential water quality impacts | |
| Golf Course | a. Evaluate potential reduction in irrigation rates | Unknown/Low |
| | b. Reduce fertilizer applications to account for nutrients in irrigation | |
| Recirculation | a. Locate and clean existing interconnecting culverts, if present | Unknown/High |
| | b. Conduct a hydraulic study to identify optimum areas for interconnecting culverts to increase recirculation | |
| | c. Install additional culverts, as necessary | |
| Street Sweeping | City to purchase regenerative air sweeper in 2022; increase sweeping to all City streets. | Low |
| Fertilizer Ordinance | a. Assist retailers with educational signage regarding summer season ban | Low |
| | b. Increase enforcement and revoke license from repeat offenders | |
| | c. Modify ordinance to require consideration of nutrients in reuse | |
| Public Education | a. Conduct public education program to inform residents of link between personal activities and water pollution | Low |
| | b. Conduct a dedicated educational program regarding responsible fertilizer use. | |
| Stormwater Utility | Adopt a Stormwater Utility to provide a dedicated funding source for water quality improvement projects | Unknown/Low |
| Regulatory Issues | The City should submit documentation for a 4e designation which would allow the City to control the process rather than FDEP | Low |
| Water Quality Monitoring | a. The City should continue the current monthly monitoring program to provide documentation on water quality improvements; improvements are recommended to enhance the existing program | Low |
| | b. Contract with a qualified water quality consultant to conduct annual reviews of data and trends and provide guidance on implementation of water quality improvement projects | |

SECTION 8

REFERENCES

- Aravena, R. and Robertson, W.D. (1998). "Use of Multiple Isotope Tracers to Evaluate Denitrification in Ground Water: Study of Nitrate from a Large-flux Septic System Plume." *Ground Water* 36: 975–982.
- APHA, AWWA, and WEF. (2012). *Standard Methods for the Examination of Water and Wastewater*, 22nd Edition.
- Belanger, T.V., and Montgomery, M.E. (1992). "Seepage Meter Errors." *Limnology and Oceanography* 37: 1787-1795.
- Breault, R.F.; Smith, K.R.; and Sorenson, J.R. (2005). "Residential Street-Dirt Accumulation Rates and Chemical Composition, and Removal Efficiencies by Mechanical- and Vacuum-Type Sweepers, New Bedford, Massachusetts, 2003-04." Scientific Investigations Report 2005-5184 (U.S. Department of the Interior/USGS).
- Bovnton, W.R.; Garber, J.H.; Summers, R.; and Kemp, W.M. (1995). "Inputs, Transformations, and Transport of Nitrogen and Phosphorus in Chesapeake Bay and Selected Tributaries." *Estuaries* 18: 285-314.
- Carlson, R.E. (1977). "A Trophic State Index for Lakes." *Limnology and Oceanography* 22: 361-369.
- Casciotti, K.L.; Sigman, D.M.; Galanter Hastings, M.; Bohlke, J.K.; and Hilkert, A. (2002). "Measurement of the Oxygen Isotopic Composition of Nitrate in Seawater and Freshwater Using the Denitrifier Method." *Anal. Chem.* 74: 4905–4912.
- Cherkauer, D.A., and McBride, M.S. (1988). "A Remotely Operated Seepage Meter for Use in Large Lakes and Rivers." *Ground Water* 26: 165-171.
- Coplen, T.B. (1996). "New Guidelines for Reporting Stable Hydrogen, Carbon, and Oxygen Isotope-ratio Data." *Geochimica et Cosmochimica Acta* 60: 3359-3360.
- Dillon, P.J., and Rigler, F.H. (1974). "The Phosphorus-Chlorophyll Relationship in Lakes." *Limnol. Oceanogra.*, Vol. 19, pp. 767-773.
- Environmental Research & Design, Inc. (ERD) (2009). "Runoff Characteristics of Natural Vegetation Communities in Florida." Prepared for the Florida Department of Environmental Protection - Contract No. SO108.

- Environmental Research & Design, Inc. (ERD). (January 2013). "Lake Killarney Hydrologic/
Nutrient Budget Evaluation." Final Report for the City of Winter Park, FL and Orange
County, FL.
- Erickson, D.R. (1981). "The Hydrology of Williams Lake, Minnesota, with Special Emphasis
on Quantification of Littoral Groundwater Contributions Using Seepage Meters and Wells."
Master's Thesis, University of Minnesota, 153 pp.
- FDACS. Urban Turf Fertilizer Rule for Home Lawn Fertilization. IFAS Publication #Enh 1089,
February 6, 2018.
- Florida Department of Environmental Protection (FDEP). (1996). "Eco Summary – Trout Lake
Near Eustis, Lake County." Report prepared October 1996.
- Florida Department of Environmental Protection (FDEP). (2006). Map prepared 4/4/06 by the
Bureau of Watershed Management, Division of Water Resource Management. Revised
8/1/06.
- Fulton, R.S., III. (1995a). "External Nutrient Budget and Trophic State Modeling for Lakes in the
Upper Ocklawaha River Basin." St. Johns River Water Management District Technical
Publication SJ95-6.
- Fulton, R.S., III. (1995b). "SWIM Plan for the Upper Ocklawaha River Basin." St. Johns River
Water Management District.
- Fulton, R.S., III; Schluter, C.; Keller, T.A.; Nagrid, S.; Godwin, W.; Smith, D.; Clapp, D.; Karama,
A.; and Richmond, J. (2003). "Interim Pollutant Load Reduction Goals for Seven Major
Lakes in the Upper Ocklawaha River Basin." (Draft) St. Johns River Water Management
District.
- Fukada, T.; Hiscock, K.M.; Dennis, P.F.; and Grischek, T. (2003). "A Dual Isotope Approach
to Identify Denitrification in Ground Water at a River Bank Infiltration Site." *Water
Res.* 37: 3070–3078.
- Harper, H.H. (1990). "Long-Term Performance Evaluation of the Alum Stormwater Treatment
System at Lake Ella." Final Report to the Florida Department of Environmental
Regulation for Project No. WM339.
- Harper, H.H., and Baker, D.M. (2007). "Evaluation of Current Stormwater Design Criteria
within the State of Florida –Final Report." Prepared for the Florida Department of
Environmental Protection - Contract No. SO108.
- Huang, X., and Smith, D.R. (2015). "Lake Apopka and the Upper Ocklawaha River – Minimum
Flows and Levels – Hydrologic Assessment Method Report" (Draft Report).
- Jones, Frank E. (1992) *Evaporation of Water*. Chelsea, MI: Lewis Publishers, Inc.

- Kendall, C. (1998). "Tracing Nitrogen Sources and Cycling in Catchments." *Isotope Tracers in Catchment Hydrology*, Edited by Kendall, C., and McDonnell, J.J. Amsterdam: Elsevier Science B.V., 839 pp.
- Kendall, C.; Silva, S.R.; Chang, C.C.Y.; Burns, D.A.; Campbell, D.H.; and Shanley, J.B. (1996). Use of the $\delta^{18}\text{O}$ and $\delta^{15}\text{N}$ of Nitrate to Determine Sources of Nitrate in Early Spring Runoff in Forested Catchments. In *Proceedings of the International Atomic Energy Agency, Symposium on Isotopes in Water Resources Management*. Vienna, Austria, March 20-24, 1995, v. 1, p. 167-176.
- Lee, D.R. (1977). "A Device for Measuring Seepage Flux in Lakes and Estuaries." *Limnology and Oceanography* 22: 140-147.
- Mayer, B.; Boyer, E.W.; Goodale, C.; Jaworski, N.A.; Van Breemen, N.; Howarth, R.W.; Seitzinger, S.; Billen, G.; Lajtha, K.; Nadelhoffer, K.; Van Dam, D.; Hetling, L.J.; Nosal, M.; and Paustian, K. (2001). "Sources of Nitrate in Rivers Draining Sixteen Watersheds in the Northeastern U.S.: Isotopic Constraints." *Biogeochemistry* 57/58: 171-197.
- McQueen, D.J., and Lean, D.R.S. (1987). "Influence of Water Temperature and Nitrogen to Phosphorus Ratios on the Dominance of Blue-Green Algae in Lake St. George, Ontario." *Can. J. Fish. Aquat. Sci.* 44: 598-604.
- Michard, J.; Aleya, L.; and Verneaux, J. (1996). "Mass Occurrence of the *Cyanobacteria Microcystis aeruginosa* in the Hypereutrophic Villerest Reservoir (Roanne, France): Usefulness of the Biyearly Examination of N/P (Nitrogen/Phosphorus) and P/C (Protein/Carbohydrate) Couplings." *Arch. Hydrobiol.* 135: 337-359.
- Miller, A.C., and Decell, J.L. (1984). "Use of the White Amur for Aquatic Plant Management." *Instruction Report A-84-1*, U.S. Army Engineer Waterways Experiment Station, Vicksburg, MS.
- Peterson, G.W., and Corey, R.B. (1966). "A Modified Chang and Jackson Procedure for Routine Fractionation of Inorganic Soil Phosphates." *Soil Sci. Soc. Am. Proc.* 30, pp. 563-565.
- Redfield, A.C. (1958). "The Biological Control of Chemical Factors in the Environment." *American Scientist*.
- Révész, K. and Casciotti, K. (2007). "Determination of the $\delta^{15}\text{N}/^{14}\text{N}$ and $\delta^{18}\text{O}/^{16}\text{O}$ of Nitrate in Water: RSIL Lab Code 2900." In Chapter C17 of *Methods of the Reston Stable Isotope Laboratory: Reston, Virginia*, Edited by Révész, Kinga, and Copen, Tyler B. U.S. Geological Survey, Techniques and Methods, book 10, sec. C, chap. 17, 24 p.
- Schindler, D.W. (1977). "The Evolution of Phosphorus Limitation in Lakes." *Science* 195: 260-262.

- Sigman, D.M.; Casciotti, K.L.; Andreani, M.; Barford, C.; Galanter, M.; and Bohlke, J.K. (2001). "A Bacterial Method for the Nitrogen Isotopic Analysis of Nitrate in Seawater and Freshwater." *Anal. Chem.* 73: 4145–4153.
- Smith, V.H. (1983). "Low Nitrogen to Phosphorus Favor Dominance by Blue-Green Algae in Lake Phytoplankton." *Science* 225: 669-671.
- Sutton, D.L., and Vandiver, V.V., Jr. (1986). "Grass Carp: A Fish for Biological Management of Hydrilla and Other Aquatic Weeds in Florida." *Bulletin No. 867*, Institute of Food and Agricultural Sciences, University of Florida, Gainesville.
- Tonno, I. (2004). Abstract: "The Impact of Nitrogen and Phosphorus Concentration and N/P Ratio on Cyanobacteria Dominance and N₂ Fixation in Some Estonian Lakes." Institute of Zoology and Hydrobiology, University of Tartu, Estonia.
- Wiley, M.J.; Tazik, P.P.; Sobaski, S.T.; and Gorden, R.W. (1984). "Biological Control of Aquatic Macrophytes by Herbivorous Carp: Part III – Stocking Recommendations for Herbivorous Carp and Description of the Illinois Herbivorous Fish Simulation System." *Aquatic Biology Technical Report 1984(12)*, Illinois Natural History Survey, Champaign, IL.
- U.S. EPA. (1981). *Procedures for Handling and Chemical Analysis of Sediments and Water Samples*. EPA/Corps of Engineers, EPA/CE-81-1.
- U.S. EPA. (1983). *Methods for Chemical Analysis of Water and Wastes*. EPA 600/4-79-020.
- U.S. EPA. (1990). *Test Methods for Evaluating Solid Wastes, Physical-Chemical Methods*, 3rd Ed. EPA-SW-846.
- Vollenweider, R.A. (1968). Water Management Research." OECD Paris. DAS/CSI/68.27. Mimeo. 183 pp.
- Vollenweider, R.A. (1968). "The Scientific Basis of Lake and Stream Eutrophication, with Particular Reference to Phosphorus and Nitrogen as Eutrophication Factors." Technical Report DAS/DSI/68.27, Organization for Economic Cooperation and Development, Paris, France.
- Vollenweider, R.A. (1976). "Advances in Defining Critical Loading Levels for Phosphorus in Lake Eutrophication." *Memorie dell' Istituto Italiano di Idrobiologia*. 33: 53-83.
- Vollenweider, R.A., and Dillon, P.J. (1974). "The Application of the Phosphorus-Loading Concept to Eutrophication Research." National Research Council, Canada, *Tech. Report 13690*.
- Wassenaar, L.I. (1995). "Evaluation of the Origin and Fate of Nitrate in the Abbotsford Aquifer Using the Isotopes of ¹⁵N and ¹⁸O in NO₃⁻." *Applied Geochemistry*, 10: 391-405.

Young, G.K.; Stein, S.; Cole, P; Kammer, T; Graziano, F; and Bank, F. (1996). "Evaluation and Management of Highway Runoff Water Quality." FHWA-PD-96-032. Federal Highway Administration, Office of Environment and Planning.

Yousef, Y.A.; McLellon, W.M.; and Zebuth, H.H. (1980). "Changes in Phosphorus Concentrations Due to Mixing by Motorboats in Shallow Lakes." *Water Research* 14, 841-852.

APPENDICES

APPENDIX A

HISTORICAL WATER QUALITY DATA FOR MARCO ISLAND AND OFF-SHORE WATERBODIES

A-1: Historical Water Quality Data for Marco Island Monitoring Sites

A-2: Mean Annual Values for Marco Island Monitoring Sites

**A-3: Temporal Plots and Regression Analyses for Marco
Island Historical Monitoring Data**

**A-4: Box and Whisker Plots for Historical Marco Island Water Quality Data
by Site**

A-5: Historical Water Quality Data for Off-Shore Waterbodies

B-6: Characteristics of Reuse Irrigation Produced by Marco Island

A-1: Historical Water Quality Data for Marco Island Monitoring Sites

Historical Water Quality Data for Marco Island Monitoring Sites from 2007 - 2020

| Station ID | Sample Date | Sample Depth | pH (s.u.) | Temp. (°C) | Diss. O ₂ (mg/L) | Diss. O ₂ (% satm.) | Cond. (µmho/cm) | Salinity (ppt) | NOx (µg/L) | TKN (µg/L) | Total N (µg/L) | Total P (µg/L) | Chl-a (mg/m ³) | Turbidity (NTU) | Secchi Depth (m) | Entero (cfu/100 mL) |
|------------|-------------|--------------|-----------|------------|-----------------------------|--------------------------------|-----------------|----------------|------------|------------|----------------|----------------|----------------------------|-----------------|------------------|---------------------|
| Hollyhock | 5/31/07 | S | | | | | | | | 790 | | | | | | 36 |
| Hollyhock | 8/1/07 | S | | | | | | | | 570 | | | | | | 260 |
| Hollyhock | 9/26/07 | S | | | | | | | | 540 | | | | | | 29 |
| Hollyhock | 11/28/07 | S | | | | | | | | 40 | | | | | | 1 |
| Hollyhock | 1/30/08 | S | | | | | | | | 260 | | | | | | 1 |
| Hollyhock | 3/12/08 | S | | | | | | | | 360 | | | | | | 20 |
| Hollyhock | 5/15/08 | S | | | | | | | | 250 | | | | | | 2 |
| Hollyhock | 7/23/08 | S | | | | | | | | 620 | | | | | | 3 |
| Hollyhock | 9/24/08 | S | | | | | | | | 610 | | | | | | 41 |
| Hollyhock | 12/10/08 | S | | | | | | | | 430 | | | | | | 1 |
| Hollyhock | 2/11/09 | S | | | | | | | | 180 | | | | | | 3 |
| Hollyhock | 4/29/09 | S | | | | | | | | 270 | | | | | | 3 |
| Hollyhock | 6/17/09 | S | | | | | | | | 138 | | | | | | 7 |
| Hollyhock | 8/27/09 | S | | | | | | | | 171 | | | | | | 42 |
| Hollyhock | 10/27/09 | S | | | | | | | | 469 | | | | | | 1 |
| Hollyhock | 12/22/09 | S | | | | | | | | 339 | | | | | | 2 |
| Hollyhock | 2/24/10 | S | | | | | | | | 150 | | | | | | 9 |
| Hollyhock | 4/21/10 | S | | | | | | | | 199 | | | | | | 2 |
| Hollyhock | 6/23/10 | S | | | | | | | | 161 | | | | | | 9 |
| Hollyhock | 9/2/10 | S | | | | | | | | 500 | | | | | | 17 |
| Hollyhock | 11/17/10 | S | | | | | | | | 59 | | | | | | 1 |
| Hollyhock | 1/26/11 | S | | | | | | | | 515 | | | | | | 227 |
| Hollyhock | 3/23/11 | S | | | | | | | | 494 | | | | | | 11 |
| Hollyhock | 5/18/11 | S | | | | | | | | 747 | | | | | | 1 |
| Hollyhock | 7/28/11 | S | | | | | | | | 513 | | | | | | 1 |
| Hollyhock | 9/28/11 | S | | | | | | | | 393 | | | | | | 4 |
| Hollyhock | 12/29/11 | S | | | | | | | | 401 | | | | | | 21 |
| Hollyhock | 2/23/12 | S | | | | | | | | 265 | | | | | | 8 |
| Hollyhock | 4/25/12 | S | | | | | | | | 384 | | | | | | 7 |
| Hollyhock | 6/27/12 | S | | | | | | | | 505 | | | | | | 3 |
| Hollyhock | 8/22/12 | S | | | | | | | | 340 | | | | | | 1 |
| Hollyhock | 10/24/12 | S | | | | | | | | 506 | | | | | | 26 |
| Hollyhock | 12/27/12 | S | | | | | | | | 420 | | | | | | 84 |
| Hollyhock | 2/27/13 | S | | | | | | | | 780 | | | | | | 83 |
| Hollyhock | 4/24/13 | S | | | | | | | | 567 | | | | | | 67 |
| Hollyhock | 6/20/13 | S | | | | | | | | 258 | | | | | | 48 |
| Hollyhock | 8/28/13 | S | | | | | | | | 250 | | | | | | 70 |
| Hollyhock | 10/30/13 | S | | | | | | | | 445 | | | | | | 58 |
| Hollyhock | 1/22/14 | S | | | | | | | | 295 | | | | | | 96 |
| Hollyhock | 3/26/14 | S | | | | | | | | 274 | | | | | | 13 |
| Hollyhock | 5/28/14 | S | | | | | | | | 375 | | | | | | 41 |
| Hollyhock | 7/30/14 | S | | | | | | | | 435 | | | | | | 10 |
| Hollyhock | 9/24/14 | S | | | | | | | | 158 | | | | | | 10 |
| Hollyhock | 1/28/15 | S | 7.84 | 19.3 | 6.8 | 90 | 53,220 | 35.2 | 27 | 63 | 185 | 28 | 1.6 | | | 10 |
| Hollyhock | 5/12/15 | S | 7.87 | 28.6 | 5.2 | 81 | 53,204 | 35.0 | 27 | 90 | 90 | 31 | 4.0 | | | 20 |
| Hollyhock | 8/25/15 | S | 7.69 | 32.0 | 5.2 | 85 | 50,277 | 32.7 | 19 | 186 | 205 | 30 | 4.1 | | | 20 |
| Hollyhock | 11/19/15 | S | 7.79 | 28.2 | 7.3 | 109 | 50,776 | 33.3 | 22 | 160 | 182 | 17 | 7.1 | | | 10 |
| Hollyhock | 2/1/16 | S | 7.73 | 19.2 | 6.2 | 78 | 40,862 | 26.2 | 133 | 376 | 509 | | | | | |
| Hollyhock | 5/10/16 | S | 7.76 | 25.8 | 4.3 | 64 | 52,976 | 34.9 | 12 | | | | | | | |
| Hollyhock | 8/11/16 | S | 7.77 | 31.0 | 4.8 | 76 | 45,163 | 29.1 | 35 | 673 | 708 | | | | | |
| Hollyhock | 11/9/16 | S | 7.79 | 23.3 | 5.0 | 71 | 53,650 | 35.5 | 16 | | | | | | 0.9 | |

Historical Water Quality Data for Marco Island Monitoring Sites from 2007 - 2020

| Station ID | Sample Date | Sample Depth | pH (s.u.) | Temp. (°C) | Diss. O ₂ (mg/L) | Diss. O ₂ (% satm.) | Cond. (µmho/cm) | Salinity (ppt) | NOx (µg/L) | TKN (µg/L) | Total N (µg/L) | Total P (µg/L) | Chyl-a (mg/m ³) | Turbidity (NTU) | Secchi Depth (m) | Entero (cfu/100 mL) |
|-------------|-------------|--------------|-----------|------------|-----------------------------|--------------------------------|-----------------|----------------|------------|------------|----------------|----------------|-----------------------------|-----------------|------------------|---------------------|
| Hummingbird | 5/31/07 | S | | | | | | | | 840 | | | | | | 2 |
| Hummingbird | 8/1/07 | S | | | | | | | | 370 | | | | | | 71 |
| Hummingbird | 9/26/07 | S | | | | | | | | 590 | | | | | | 2 |
| Hummingbird | 11/28/07 | S | | | | | | | | 560 | | | | | | 1 |
| Hummingbird | 1/30/08 | S | | | | | | | | 190 | | | | | | 1 |
| Hummingbird | 3/12/08 | S | | | | | | | | 460 | | | | | | 6 |
| Hummingbird | 5/15/08 | S | | | | | | | | 280 | | | | | | 1 |
| Hummingbird | 7/23/08 | S | | | | | | | | 680 | | | | | | 3 |
| Hummingbird | 9/24/08 | S | | | | | | | | 100 | | | | | | 1 |
| Hummingbird | 12/10/08 | S | | | | | | | | 370 | | | | | | 2 |
| Hummingbird | 2/11/09 | S | | | | | | | | 76 | | | | | | 1 |
| Hummingbird | 4/29/09 | S | | | | | | | | 790 | | | | | | 4 |
| Hummingbird | 6/17/09 | S | | | | | | | | 257 | | | | | | 2 |
| Hummingbird | 8/27/09 | S | | | | | | | | 267 | | | | | | 11 |
| Hummingbird | 10/27/09 | S | | | | | | | | 892 | | | | | | 6 |
| Hummingbird | 12/22/09 | S | | | | | | | | 238 | | | | | | 1 |
| Hummingbird | 2/24/10 | S | | | | | | | | 59 | | | | | | 1 |
| Hummingbird | 4/21/10 | S | | | | | | | | 392 | | | | | | 3 |
| Hummingbird | 6/23/10 | S | | | | | | | | 194 | | | | | | 19 |
| Hummingbird | 9/2/10 | S | | | | | | | | 1,311 | | | | | | 9 |
| Hummingbird | 11/17/10 | S | | | | | | | | 59 | | | | | | 1 |
| Hummingbird | 1/26/11 | S | | | | | | | | 592 | | | | | | 95 |
| Hummingbird | 3/23/11 | S | | | | | | | | 359 | | | | | | 4 |
| Hummingbird | 5/18/11 | S | | | | | | | | 366 | | | | | | 3 |
| Hummingbird | 7/28/11 | S | | | | | | | | 425 | | | | | | 2 |
| Hummingbird | 9/28/11 | S | | | | | | | | 499 | | | | | | 9 |
| Hummingbird | 12/29/11 | S | | | | | | | | 467 | | | | | | 6 |
| Hummingbird | 4/25/12 | S | | | | | | | | 320 | | | | | | 3 |
| Hummingbird | 6/27/12 | S | | | | | | | | 557 | | | | | | 8 |
| Hummingbird | 8/22/12 | S | | | | | | | | 729 | | | | | | 42 |
| Hummingbird | 10/24/12 | S | | | | | | | | 300 | | | | | | 2 |
| Hummingbird | 12/27/12 | S | | | | | | | | 467 | | | | | | 10 |
| Hummingbird | 4/24/13 | S | | | | | | | | 572 | | | | | | 38 |
| Hummingbird | 6/20/13 | S | | | | | | | | 634 | | | | | | 14 |
| Hummingbird | 8/28/13 | S | | | | | | | | 322 | | | | | | 97 |
| Hummingbird | 10/30/13 | S | | | | | | | | 236 | | | | | | 17 |
| Hummingbird | 1/22/14 | S | | | | | | | | 288 | | | | | | 64 |
| Hummingbird | 3/26/14 | S | | | | | | | | 175 | | | | | | 120 |
| Hummingbird | 5/28/14 | S | | | | | | | | 203 | | | | | | 10 |
| Hummingbird | 7/30/14 | S | | | | | | | | 295 | | | | | | 10 |
| Hummingbird | 9/24/14 | S | | | | | | | | 462 | | | | | | 10 |
| Hummingbird | 1/28/15 | S | 7.81 | 20.0 | 6.6 | 90 | 52,651 | 34.8 | 28 | 109 | 137 | 40 | 1.3 | | | 10 |
| Hummingbird | 5/12/15 | S | 7.86 | 29.5 | 5.1 | 81 | 52,484 | 34.4 | 18 | 51 | 69 | 29 | 5.2 | | | 10 |
| Hummingbird | 8/25/15 | S | 7.96 | 32.6 | 5.3 | 87 | 49,904 | 32.4 | 17 | 222 | 239 | 30 | 5.8 | | | 10 |
| Hummingbird | 11/19/15 | S | 7.60 | 26.4 | 5.6 | 83 | 49,788 | 32.6 | 38 | 220 | 258 | 14 | 4.8 | | | 41 |
| Hummingbird | 2/1/16 | S | 8.03 | 19.4 | 9.8 | 123 | 37,554 | 23.9 | 56 | 342 | 398 | | | | | |
| Hummingbird | 5/10/16 | S | 7.84 | 26.1 | 5.6 | 83 | 52,132 | 34.3 | 15 | | | | | | | |
| Hummingbird | 8/11/16 | S | 7.85 | 30.3 | 5.5 | 85 | 45,852 | 29.6 | 9 | 813 | 822 | | | | | |
| Hummingbird | 11/9/16 | S | 7.89 | 23.9 | 6.7 | 96 | 52,771 | 34.8 | | | | | | | | |
| Hummingbird | 2/21/17 | S | 7.73 | 23.8 | 6.3 | 90 | 52,422 | 34.6 | 4 | 458 | 462 | 21 | 5.7 | | 1.4 | 10 |
| Hummingbird | 5/18/17 | S | 7.83 | 29.1 | 5.5 | 88 | 54,502 | 36.0 | 5 | 568 | 573 | 34 | 5.8 | | 1.4 | 10 |
| Hummingbird | 8/16/17 | S | 7.99 | 33.4 | 6.2 | 101 | 43,369 | 27.7 | 4 | 499 | 503 | 22 | 4.0 | | 1.4 | |

Historical Water Quality Data for Marco Island Monitoring Sites from 2007 - 2020

| Station ID | Sample Date | Sample Depth | pH (s.u.) | Temp. (°C) | Diss. O ₂ (mg/L) | Diss. O ₂ (% satm.) | Cond. (µmho/cm) | Salinity (ppt) | NOx (µg/L) | TKN (µg/L) | Total N (µg/L) | Total P (µg/L) | Chl-a (mg/m ³) | Turbidity (NTU) | Secchi Depth (m) | Entero (cfu/100 mL) |
|------------|-------------|--------------|-----------|------------|-----------------------------|--------------------------------|-----------------|----------------|------------|------------|----------------|----------------|----------------------------|-----------------|------------------|---------------------|
| Kendall | 1/27/15 | S | 7.71 | 19.7 | 6.4 | 86 | 51,418 | 33.9 | 27 | 346 | 373 | | | | | |
| Kendall | 5/12/15 | S | 7.87 | 28.1 | 4.9 | 76 | 52,350 | 34.4 | 17 | | | | | | 1.2 | |
| Kendall | 8/25/15 | S | 7.94 | 32.4 | 5.7 | 94 | 51,136 | 33.3 | 18 | | | | | | 1.4 | |
| Kendall | 11/19/15 | S | 7.82 | 28.6 | 5.0 | 75 | 49,161 | 32.1 | 55 | 241 | 296 | | | | 2.3 | |
| Kendall | 2/1/16 | S | 7.69 | 19.5 | 7.2 | 90 | 39,577 | 25.1 | 148 | 284 | 432 | | | | 2.3 | |
| Kendall | 5/10/16 | S | 7.74 | 26.0 | 5.5 | 82 | 51,749 | 34.0 | | | | | | | | |
| Kendall | 8/11/16 | S | 7.91 | 30.6 | 5.2 | 82 | 47,263 | 30.6 | 24 | 600 | 624 | | | | | |
| Kendall | 11/9/16 | S | 7.79 | 23.9 | 6.3 | 91 | 53,250 | 35.1 | | | | | | | | |
| Kendall | 2/21/17 | S | 7.80 | 23.8 | 5.8 | 84 | 52,423 | 34.6 | 3 | 475 | 478 | 29 | 2.5 | | 1.1 | |
| Kendall | 5/18/17 | S | 7.80 | 28.6 | 5.4 | 84 | 53,447 | 35.3 | 2 | 750 | 752 | 42 | 5.7 | | 1.1 | 10 |
| Kendall | 8/16/17 | S | 8.01 | 32.6 | 5.9 | 95 | 46,639 | 30.1 | 2 | 408 | 410 | 30 | 3.9 | | 1.5 | |
| Kendall | 8/16/17 | B | 8.02 | 32.9 | 4.9 | 81 | 48,526 | 31.4 | | | | | | | | |
| Kendall | 11/13/17 | S | 7.63 | 25.5 | 5.5 | 81 | 49,715 | 32.5 | 4 | 1,160 | 1,164 | 33 | 2.8 | | 1.2 | 10 |
| Kendall | 11/13/17 | B | 7.75 | 25.4 | 5.6 | 81 | 49,855 | 32.6 | | | | | | | | |
| Kendall | 2/8/18 | S | 7.89 | 22.8 | 7.5 | 105 | 51,969 | 34.2 | | 134 | 134 | 7 | 1.4 | | 0.9 | 10 |
| Kendall | 5/21/18 | S | 7.72 | 26.1 | 4.6 | 68 | 52,137 | 34.3 | 19 | 1,130 | 1,149 | 56 | 1.6 | | 1.3 | 20 |
| Kendall | 5/21/18 | B | 7.74 | 26.1 | 4.5 | 68 | 52,145 | 34.3 | | | | | | | | |
| Kendall | 8/16/18 | S | 7.94 | 31.0 | 5.0 | 80 | 51,684 | 33.8 | 11 | 553 | 564 | 73 | 5.1 | | 1.0 | 211 |
| Kendall | 11/15/18 | S | 7.70 | 27.9 | 5.0 | 77 | 51,203 | 33.6 | 11 | 1,030 | 1,041 | 62 | 5.0 | | 0.7 | 431 |
| Kendall | 2/26/19 | S | 7.67 | 25.8 | 5.2 | 76 | 50,713 | 33.2 | 11 | 289 | 300 | 65 | 3.7 | | 1.0 | 31 |
| Kendall | 5/13/19 | S | 7.79 | 30.0 | 5.5 | 88 | 52,308 | 34.3 | 11 | 874 | 885 | 67 | 7.4 | | 1.0 | 10 |
| Kendall | 8/7/19 | S | 7.93 | 30.5 | 6.7 | 105 | 46,640 | 30.1 | 11 | 590 | 601 | 74 | 11.7 | | 0.8 | 10 |
| Kendall | 10/23/19 | S | 7.74 | 29.9 | 5.1 | 81 | 50,705 | 33.1 | | | | | | | | |
| Kendall | 10/23/19 | B | 7.75 | 30.0 | 5.2 | 82 | 50,700 | 33.1 | | | | | | | | |
| Kendall | 11/4/19 | S | 7.66 | 29.1 | 4.2 | 65 | 50,235 | 32.8 | 22 | 1,120 | 1,142 | 84 | 6.7 | 5.6 | 0.8 | 10 |
| Kendall | 12/18/19 | S | 7.83 | 24.5 | 4.9 | 71 | 51,555 | 33.9 | 32 | 626 | 658 | 69 | 3.7 | 5.7 | 0.6 | 197 |
| Kendall | 1/15/20 | S | 7.80 | 23.6 | 6.3 | 88 | 50,446 | 33.1 | 11 | 725 | 736 | 57 | 3.2 | 5.7 | 0.6 | 10 |
| Kendall | 2/4/20 | S | 7.73 | 20.0 | 6.6 | 88 | 50,127 | 32.9 | 16 | 711 | 727 | 30 | 1.5 | 3.7 | 0.9 | 10 |
| Kendall | 4/14/20 | S | 7.76 | 28.8 | 5.4 | 85 | 55,751 | 36.9 | 11 | 581 | 592 | 45 | 3.2 | 4.3 | 1.4 | 10 |
| Kendall | 5/14/20 | S | 7.86 | 25.4 | 5.6 | 83 | 54,558 | 36.1 | 33 | 510 | 543 | 93 | 5.1 | 8.0 | 1.0 | 10 |
| Kendall | 6/15/20 | S | 7.89 | 30.6 | 4.9 | 78 | 49,878 | 32.5 | 11 | 705 | 716 | 48 | 2.1 | 2.6 | 1.2 | 10 |
| Kendall | 7/28/20 | S | 7.77 | 30.6 | 5.1 | 81 | 48,535 | 31.5 | 11 | 554 | 565 | 48 | 3.1 | 3.2 | 1.0 | 10 |
| Kendall | 7/28/20 | S | 7.77 | 30.6 | 5.1 | 81 | 48,499 | 31.5 | 11 | 644 | 655 | 45 | 4.7 | 3.0 | 1.0 | 10 |
| Kendall | 8/25/20 | S | 7.83 | 30.8 | 5.0 | 79 | 48,408 | 31.4 | 11 | 775 | 786 | 44 | 4.8 | 3.1 | 1.0 | 10 |
| Kendall | 9/23/20 | S | 7.97 | 29.2 | 6.0 | 91 | 44,037 | 28.3 | 11 | | 416 | 56 | 5.3 | 2 | 0.95 | 110 |
| Kendall | 9/23/20 | B | | | | | | | | | 416 | 56 | 5.3 | | | 110 |
| Kendall | 10/22/20 | B | | | | | | | | | 370 | 9 | 4.8 | | | 50 |
| Kendall | 11/23/20 | S | 8.11 | 24.8 | 3.6 | 53 | 47,333 | 30.8 | 35 | | 430 | 18 | 2.5 | 1.4 | 1.5 | 10 |
| Kendall | 11/23/20 | B | | | | | | | | | 430 | 18 | 2.5 | | | 10 |
| Kendall | 12/10/20 | S | 8.18 | 20.1 | 5.0 | 65 | 48,206 | 31.5 | 40 | | 370 | 18 | 2.5 | 0.43 | 1.5 | 10 |
| Kendall | 12/10/20 | B | | | | | | | | | 370 | 18 | 2.5 | | | 10 |

Historical Water Quality Data for Marco Island Monitoring Sites from 2007 - 2020

| Station ID | Sample Date | Sample Depth | pH (s.u.) | Temp. (°C) | Diss. O ₂ (mg/L) | Diss. O ₂ (% satm.) | Cond. (µmho/cm) | Salinity (ppt) | NOx (µg/L) | TKN (µg/L) | Total N (µg/L) | Total P (µg/L) | Chl-a (mg/m ³) | Turbidity (NTU) | Secchi Depth (m) | Entero (cfu/100 mL) |
|------------|-------------|--------------|-----------|------------|-----------------------------|--------------------------------|-----------------|----------------|------------|------------|----------------|----------------|----------------------------|-----------------|------------------|---------------------|
| Melvaine | 5/31/07 | S | | | | | | | | 630 | | | | | | 1 |
| Melvaine | 8/1/07 | S | | | | | | | | 410 | | | | | | 413 |
| Melvaine | 9/26/07 | S | | | | | | | | 430 | 2 | | | | | 2 |
| Melvaine | 11/28/07 | S | | | | | | | | 580 | 1 | | | | | 1 |
| Melvaine | 1/30/08 | S | | | | | | | | 180 | | | | | | 1 |
| Melvaine | 3/12/08 | S | | | | | | | | 80 | | | | | | 1 |
| Melvaine | 5/15/08 | S | | | | | | | | 260 | | | | | | 1 |
| Melvaine | 7/23/08 | S | | | | | | | | 450 | | | | | | 46 |
| Melvaine | 9/24/08 | S | | | | | | | | 630 | 7 | | | | | 7 |
| Melvaine | 12/10/08 | S | | | | | | | | 210 | 4 | | | | | 4 |
| Melvaine | 2/11/09 | S | | | | | | | | 128 | 2 | | | | | 2 |
| Melvaine | 4/29/09 | S | | | | | | | | 667 | | | | | | 1 |
| Melvaine | 6/17/09 | S | | | | | | | | 76 | 1 | | | | | 1 |
| Melvaine | 8/27/09 | S | | | | | | | | 76 | | | | | | 48 |
| Melvaine | 10/27/09 | S | | | | | | | | 692 | 2 | | | | | 2 |
| Melvaine | 12/22/09 | S | | | | | | | | 185 | 4 | | | | | 4 |
| Melvaine | 2/24/10 | S | | | | | | | | 270 | | | | | | 1 |
| Melvaine | 4/21/10 | S | | | | | | | | 235 | 1 | | | | | 1 |
| Melvaine | 6/23/10 | S | | | | | | | | 102 | 1 | | | | | 1 |
| Melvaine | 9/2/10 | S | | | | | | | | 621 | | | | | | 10 |
| Melvaine | 11/17/10 | S | | | | | | | | 59 | 3 | | | | | 3 |
| Melvaine | 1/26/11 | S | | | | | | | | 554 | | | | | | 173 |
| Melvaine | 3/23/11 | S | | | | | | | | 235 | | | | | | 6 |
| Melvaine | 5/18/11 | S | | | | | | | | 298 | 1 | | | | | 1 |
| Melvaine | 7/28/11 | S | | | | | | | | 297 | 1 | | | | | 1 |
| Melvaine | 9/28/11 | S | | | | | | | | 471 | 2 | | | | | 2 |
| Melvaine | 12/29/11 | S | | | | | | | | 303 | | | | | | 1 |
| Melvaine | 2/23/12 | S | | | | | | | | 185 | 1 | | | | | 1 |
| Melvaine | 4/25/12 | S | | | | | | | | 480 | | | | | | 4 |
| Melvaine | 6/27/12 | S | | | | | | | | 433 | | | | | | 100 |
| Melvaine | 8/22/12 | S | | | | | | | | 159 | 1 | | | | | 1 |
| Melvaine | 10/24/12 | S | | | | | | | | 441 | | | | | | 10 |
| Melvaine | 12/27/12 | S | | | | | | | | 310 | | | | | | 20 |
| Melvaine | 2/27/13 | S | | | | | | | | 491 | 46 | | | | | 46 |
| Melvaine | 4/24/13 | S | | | | | | | | 372 | 1 | | | | | 1 |
| Melvaine | 6/20/13 | S | | | | | | | | 92 | | | | | | 14 |
| Melvaine | 8/28/13 | S | | | | | | | | 115 | 16 | | | | | 16 |
| Melvaine | 10/30/13 | S | | | | | | | | 387 | | | | | | 250 |
| Melvaine | 1/22/14 | S | | | | | | | | 260 | 30 | | | | | 30 |
| Melvaine | 3/26/14 | S | | | | | | | | 287 | 7 | | | | | 7 |
| Melvaine | 5/28/14 | S | | | | | | | | 256 | 10 | | | | | 10 |
| Melvaine | 7/30/14 | S | | | | | | | | 164 | 10 | | | | | 10 |
| Melvaine | 9/24/14 | S | | | | | | | | 154 | 83 | | | | | 10 |
| Melvaine | 1/28/15 | S | 7.99 | 18.5 | 7.6 | 100 | 52,818 | 34.9 | 20 | 51 | 174 | 83 | 4.3 | | 0.5 | 10 |
| Melvaine | 5/12/15 | S | 8.00 | 28.3 | 6.2 | 97 | 52,492 | 34.5 | 15 | 66 | 66 | 14 | 2.6 | | | 10 |
| Melvaine | 8/25/15 | S | 8.02 | 31.7 | 5.8 | 96 | 53,091 | 34.8 | 15 | 632 | 647 | 17 | 3.6 | | | 10 |
| Melvaine | 11/19/15 | S | 7.92 | 26.1 | 7.0 | 104 | 52,595 | 34.6 | 20 | 83 | 103 | 31 | 4.0 | | 2.8 | 10 |
| Melvaine | 2/1/16 | S | 8.00 | 18.1 | 7.5 | 96 | 48,510 | 31.7 | 24 | | 275 | | | | 1.5 | |
| Melvaine | 5/10/16 | S | 8.00 | 25.5 | 6.2 | 92 | 53,031 | 35.0 | 11 | | | | | | 1.0 | |
| Melvaine | 8/11/16 | S | 8.00 | 30.1 | 6.2 | 96 | 47,266 | 30.6 | 3 | 462 | 465 | | | | 1.2 | |
| Melvaine | 11/9/16 | S | 7.97 | 23.0 | 6.6 | 94 | 53,840 | 35.6 | 3 | | | | | | | |

Historical Water Quality Data for Marco Island Monitoring Sites from 2007 - 2020

| Station ID | Sample Date | Sample Depth | pH (s.u.) | Temp. (°C) | Diss. O ₂ (mg/L) | Diss. O ₂ (% satm.) | Cond. (µmho/cm) | Salinity (ppt) | NOx (µg/L) | TKN (µg/L) | Total N (µg/L) | Total P (µg/L) | Chl-a (mg/m ³) | Turbidity (NTU) | Secchi Depth (m) | Entero (cfu/100 mL) |
|------------|-------------|--------------|-----------|------------|-----------------------------|--------------------------------|-----------------|----------------|------------|------------|----------------|----------------|----------------------------|-----------------|------------------|---------------------|
| MelVaine | 2/8/18 | S | 7.96 | 21.4 | 6.8 | 94 | 54,238 | 35.9 | 12 | 278 | 290 | 21 | 2.1 | | 1 | 10 |
| MelVaine | 2/8/18 | B | 7.95 | 21.3 | 6.7 | 93 | 54,229 | 35.9 | | | | | | | | |
| MelVaine | 5/21/18 | S | 7.81 | 26.0 | 5.5 | 82 | 54,528 | 36.1 | 16 | 655 | 671 | 37 | 2.1 | | 1.4 | 20 |
| MelVaine | 8/16/18 | S | 8.09 | 30.5 | 5.7 | 92 | 52,439 | 34.4 | 11 | 590 | 601 | 69 | 3.4 | | 1.5 | 305 |
| MelVaine | 8/16/18 | B | 8.10 | 30.4 | 5.9 | 94 | 52,638 | 34.5 | | | | | | | | |
| MelVaine | 11/15/18 | S | | | | | | | | | 809 | 72 | 3.5 | | | |
| MelVaine | 11/15/18 | B | 7.91 | 27.0 | 5.1 | 77 | 52,881 | 34.8 | 18 | 809 | 827 | 72 | 3.5 | | 0.8 | 30 |
| MelVaine | 11/4/19 | S | | | | | | | | | 581 | 60 | 4.1 | | | |
| MelVaine | 11/15/20 | S | | | | | | | | | 230 | 69 | 4.5 | | | |
| MelVaine | 2/4/20 | S | | | | | | | | | 679 | 29 | 2.3 | | | |
| MelVaine | 4/4/20 | S | | | | | | | | | 1,990 | 53 | 3.9 | | | |
| MelVaine | 5/15/20 | S | | | | | | | | | 400 | 88 | 2.6 | | | |
| MelVaine | 6/15/20 | S | | | | | | | | | 781 | 28 | 1.6 | | | |
| MelVaine | 7/28/20 | S | | | | | | | | | 541 | 37 | 2.9 | | | |
| MelVaine | 8/25/20 | S | | | | | | | | | 637 | 25 | 3.9 | | | 10 |
| MelVaine | 9/23/20 | S | 7.99 | 28.6 | 5.4 | 83 | 49,844 | 32.5 | 11 | 578 | 589 | 36 | 2.6 | 2.4 | 2 | 10 |
| MelVaine | 9/23/20 | B | 8.03 | 28.7 | 5.5 | 86 | 51,330 | 32.6 | | | | | | | | |
| MelVaine | 10/22/20 | B | | | | | | | | | 420 | 6 | 2.5 | | | 50 |
| MelVaine | 11/23/20 | S | 8.24 | 24.7 | 4.0 | 53 | 51,440 | 33.3 | 33 | 260 | 293 | 8 | 2.5 | 1.3 | 2.2 | 10 |
| MelVaine | 11/23/20 | B | | | | | | | | | 300 | 8 | 2.5 | | | |
| MelVaine | 12/10/20 | S | 8.24 | 19.4 | 5.2 | 70 | 50,477 | 33.2 | 28 | 250 | 278 | 6 | 2.5 | 0.69 | 2.2 | 10 |
| MelVaine | 12/10/20 | B | | | | | | | | | 270 | 6 | 2.5 | | | 10 |

Historical Water Quality Data for Marco Island Monitoring Sites from 2007 - 2020

| Station ID | Sample Date | Sample Depth | pH (s.u.) | Temp. (°C) | Diss. O ₂ (mg/L) | Diss. O ₂ (% satm.) | Cond. (µmho/cm) | Salinity (ppt) | NOx (µg/L) | TKN (µg/L) | Total N (µg/L) | Total P (µg/L) | Chl-a (mg/m ³) | Turbidity (NTU) | Secchi Depth (m) | Entero (cfu/100 mL) |
|------------|-------------|--------------|-----------|------------|-----------------------------|--------------------------------|-----------------|----------------|------------|------------|----------------|----------------|----------------------------|-----------------|------------------|---------------------|
| Olde Marco | 10/23/19 | S | 7.82 | 29.1 | 4.7 | 74 | 51,819 | 34.0 | | | | | | | 0.9 | |
| Olde Marco | 11/4/19 | S | 7.90 | 27.8 | 5.1 | 79 | 52,189 | 34.3 | 11 | 1,560 | 1,571 | 64 | 3.9 | 5.5 | 1.5 | 285 |
| Olde Marco | 11/4/19 | B | 7.91 | 27.8 | 5.2 | 80 | 52,209 | 34.3 | | | | | | | | |
| Olde Marco | 12/18/19 | S | 8.02 | 22.8 | 6.9 | 96 | 47,372 | 30.9 | 11 | 322 | 333 | 40 | 2.2 | 2.3 | 1.6 | 228 |
| Olde Marco | 12/18/19 | B | 8.01 | 23.9 | 6.3 | 91 | 52,480 | 34.6 | | | | | | | | |
| Olde Marco | 1/15/20 | S | 7.62 | 22.7 | 6.1 | 86 | 51,984 | 34.2 | 11 | 567 | 578 | 57 | 2.3 | 6.4 | 1.1 | 10 |
| Olde Marco | 2/4/20 | S | 7.83 | 18.6 | 7.3 | 95 | 51,142 | 33.7 | 11 | 747 | 758 | 25 | 1.6 | 6.0 | 1.4 | 10 |
| Olde Marco | 2/4/20 | B | 7.85 | 18.6 | 7.3 | 95 | 51,174 | 33.7 | | | | | | | | |
| Olde Marco | 4/14/20 | S | 7.84 | 28.0 | 5.5 | 86 | 56,343 | 37.4 | 11 | 725 | 736 | 77 | 5.4 | 16.0 | 0.8 | 10 |
| Olde Marco | 4/14/20 | B | 7.90 | 28.0 | 5.5 | 86 | 56,347 | 37.4 | | | | | | | | |
| Olde Marco | 5/14/20 | S | 8.00 | 25.2 | 6.1 | 91 | 55,113 | 36.5 | 33 | 410 | 443 | 50 | 2.0 | 5.8 | 1.4 | 10 |
| Olde Marco | 5/14/20 | B | 8.00 | 25.3 | 5.9 | 88 | 55,117 | 36.5 | | | | | | | | |
| Olde Marco | 6/15/20 | S | 7.96 | 29.3 | 5.1 | 80 | 51,786 | 33.9 | 11 | 819 | 830 | 40 | 1.7 | 3.5 | 1.8 | 10 |
| Olde Marco | 6/15/20 | B | 8.01 | 29.5 | 5.4 | 85 | 54,183 | 35.7 | | | | | | | | |
| Olde Marco | 7/28/20 | S | 7.79 | 29.5 | 4.8 | 76 | 52,366 | 34.4 | 11 | 590 | 601 | 36 | 2.2 | 4.3 | 1.4 | 20 |
| Olde Marco | 8/25/20 | S | 7.91 | 30.0 | 5.2 | 83 | 51,961 | 34.0 | 11 | 536 | 547 | 15 | 3.7 | 2.2 | 1.6 | 10 |
| Olde Marco | 8/25/20 | B | 7.91 | 30.1 | 5.0 | 80 | 51,934 | 34.0 | | | | | | | | |
| Olde Marco | 9/23/20 | S | 7.98 | 27.6 | 5.7 | 86 | 48,907 | 31.9 | 11 | 919 | 930 | 27 | 4.0 | 2.2 | 1.85 | 10 |
| Olde Marco | 9/23/20 | B | 7.98 | 28.0 | 5.3 | 803 | 50,189 | 32.8 | | | | | | | 1.85 | |
| Olde Marco | 10/22/20 | B | | | | | | | | | | | | | | |
| Olde Marco | 11/23/20 | S | 8.21 | 24.2 | 3.8 | 55 | 51,837 | 34.2 | 16 | 270 | 286 | 5 | 4.0 | 1.2 | 1.8 | 50 |
| Olde Marco | 11/23/20 | B | | | | | | | | | | 5 | 2.5 | 1.2 | | 10 |
| Olde Marco | 12/10/20 | S | 8.21 | 18.4 | 5.4 | 70 | 50,554 | 33.2 | 10 | 290 | 300 | 5 | 8.0 | 1.4 | 1.5 | 10 |
| Olde Marco | 12/10/20 | B | | | | | | | | | 300 | 8 | 8.0 | | | 10 |

Historical Water Quality Data for Marco Island Monitoring Sites from 2007 - 2020

| Station ID | Sample Date | Sample Depth | pH (s.u.) | Temp. (°C) | Diss. O ₂ (mg/L) | Diss. O ₂ (% satm.) | Cond. (µmho/cm) | Salinity (ppt) | NOx (µg/L) | TKN (µg/L) | Total N (µg/L) | Total P (µg/L) | Chl-a (mg/m ³) | Turbidity (NTU) | Secchi Depth (m) | Entero (cfu/100 mL) |
|------------|-------------|--------------|-----------|------------|-----------------------------|--------------------------------|-----------------|----------------|------------|------------|----------------|----------------|----------------------------|-----------------|------------------|---------------------|
| Perrine | 5/30/07 | S | | | | | | | | 630 | | | | | | 1 |
| Perrine | 7/31/07 | S | | | | | | | | 480 | | | | | | 1 |
| Perrine | 9/25/07 | S | | | | | | | | 330 | 1 | | | | | 1 |
| Perrine | 11/27/07 | S | | | | | | | | 470 | 1 | | | | | 1 |
| Perrine | 1/29/08 | S | | | | | | | | 230 | 2 | | | | | 2 |
| Perrine | 3/11/08 | S | | | | | | | | 470 | 7 | | | | | 7 |
| Perrine | 5/14/08 | S | | | | | | | | 430 | 1 | | | | | 1 |
| Perrine | 7/22/08 | S | | | | | | | | 700 | 1 | | | | | 1 |
| Perrine | 9/23/08 | S | | | | | | | | 630 | 16 | | | | | 16 |
| Perrine | 12/9/08 | S | | | | | | | | 420 | 1 | | | | | 1 |
| Perrine | 2/10/09 | S | | | | | | | | 349 | 16 | | | | | 16 |
| Perrine | 4/28/09 | S | | | | | | | | 833 | 1 | | | | | 1 |
| Perrine | 6/16/09 | S | | | | | | | | 352 | 2 | | | | | 2 |
| Perrine | 8/26/09 | S | | | | | | | | 76 | 1 | | | | | 1 |
| Perrine | 10/26/09 | S | | | | | | | | 76 | 1 | | | | | 1 |
| Perrine | 12/21/09 | S | | | | | | | | 316 | 13 | | | | | 13 |
| Perrine | 2/23/10 | S | | | | | | | | 150 | 1 | | | | | 1 |
| Perrine | 4/20/10 | S | | | | | | | | 113 | 1 | | | | | 1 |
| Perrine | 6/22/10 | S | | | | | | | | 116 | 7 | | | | | 7 |
| Perrine | 9/1/10 | S | | | | | | | | 962 | 9 | | | | | 9 |
| Perrine | 11/16/10 | S | | | | | | | | 59 | 1 | | | | | 1 |
| Perrine | 1/25/11 | S | | | | | | | | 593 | 19 | | | | | 19 |
| Perrine | 3/22/11 | S | | | | | | | | 441 | 13 | | | | | 13 |
| Perrine | 5/17/11 | S | | | | | | | | 381 | 27 | | | | | 27 |
| Perrine | 7/27/11 | S | | | | | | | | 530 | 1 | | | | | 1 |
| Perrine | 9/27/11 | S | | | | | | | | 561 | 10 | | | | | 10 |
| Perrine | 12/28/11 | S | | | | | | | | 345 | 34 | | | | | 34 |
| Perrine | 2/22/12 | S | | | | | | | | 488 | 1 | | | | | 1 |
| Perrine | 4/24/12 | S | | | | | | | | 391 | 19 | | | | | 19 |
| Perrine | 6/26/12 | S | | | | | | | | 514 | 31 | | | | | 31 |
| Perrine | 8/21/12 | S | | | | | | | | 322 | 18 | | | | | 18 |
| Perrine | 10/23/12 | S | | | | | | | | 430 | 2 | | | | | 2 |
| Perrine | 12/26/12 | S | | | | | | | | 370 | 16 | | | | | 16 |
| Perrine | 2/26/13 | S | | | | | | | | 625 | 10 | | | | | 10 |
| Perrine | 4/23/13 | S | | | | | | | | 563 | 24 | | | | | 24 |
| Perrine | 6/19/13 | S | | | | | | | | 213 | 36 | | | | | 36 |
| Perrine | 8/27/13 | S | | | | | | | | 339 | 56 | | | | | 56 |
| Perrine | 10/29/13 | S | | | | | | | | 248 | 52 | | | | | 52 |
| Perrine | 1/21/14 | S | | | | | | | | 193 | 157 | | | | | 157 |
| Perrine | 3/25/14 | S | | | | | | | | 542 | 4 | | | | | 4 |
| Perrine | 5/27/14 | S | | | | | | | | 198 | 10 | | | | | 10 |
| Perrine | 7/29/14 | S | | | | | | | | 288 | 10 | | | | | 10 |
| Perrine | 9/23/14 | S | | | | | | | | 130 | 32 | | | | | 32 |
| Perrine | 1/27/15 | S | 7.81 | 19.0 | 7.4 | 98 | 51,690 | 34.1 | 22 | 152 | 179 | 27 | 2.8 | | 0.7 | 10 |
| Perrine | 5/12/15 | S | 7.89 | 27.6 | 5.2 | 79 | 51,921 | 34.1 | 18 | 161 | 200 | 16 | 2.1 | | | 10 |
| Perrine | 8/25/15 | S | 7.97 | 32.2 | 6.0 | 98 | 51,620 | 33.7 | 15 | 185 | 203 | 37 | 4.8 | | | 10 |
| Perrine | 11/19/15 | S | 7.90 | 28.6 | 5.9 | 88 | 50,483 | 33.1 | 30 | 173 | 789 | | 4.0 | | | 10 |
| Perrine | 2/1/16 | S | 7.83 | 19.1 | 7.5 | 96 | 44,419 | 28.6 | 50 | 769 | | | | | | |
| Perrine | 8/11/16 | S | 8.00 | 31.3 | 6.9 | 109 | 47,707 | 30.9 | 20 | | | | | | | |
| Perrine | 11/9/16 | S | 7.65 | 22.9 | 6.1 | 87 | 53,562 | 35.3 | | | | | | | | |
| Perrine | 2/21/17 | S | 7.80 | 22.8 | 6.4 | 90 | 52,693 | 34.8 | 23 | 574 | 597 | 29 | 2.6 | | 0.2 | 20 |

Historical Water Quality Data for Marco Island Monitoring Sites from 2007 - 2020

| Station ID | Sample Date | Sample Depth | pH (s.u.) | Temp. (°C) | Diss. O ₂ (mg/L) | Diss. O ₂ (% satm.) | Cond. (µmho/cm) | Salinity (ppt) | NOx (µg/L) | TKN (µg/L) | Total N (µg/L) | Total P (µg/L) | Chl-a (mg/m ³) | Turbidity (NTU) | Secchi Depth (m) | Entero (cfu/100 mL) |
|------------|-------------|--------------|-----------|------------|-----------------------------|--------------------------------|-----------------|----------------|------------|------------|----------------|----------------|----------------------------|-----------------|------------------|---------------------|
| Swallow | 10/23/19 | S | 7.98 | 29.7 | 7.5 | 119 | 50,953 | 33.3 | | | | | | | 1.5 | |
| Swallow | 11/4/19 | S | 7.83 | 29.2 | 3.8 | 59 | 49,589 | 32.3 | 28 | 850 | 878 | 86 | 7.9 | 4.0 | 1.3 | 10 |
| Swallow | 12/18/19 | S | 8.01 | 23.6 | 6.3 | 89 | 45,751 | 29.7 | 45 | 547 | 592 | 100 | 5.9 | 4.7 | 1.1 | 24,196 |
| Swallow | 1/15/20 | S | 7.81 | 23.0 | 5.5 | 77 | 50,346 | 33.0 | 11 | 781 | 792 | 61 | 4.1 | 3.5 | 1.2 | 10 |
| Swallow | 2/3/20 | S | 7.70 | 17.7 | 5.4 | 67 | 44,608 | 28.9 | 76 | 774 | 850 | 58 | 1.2 | 4.6 | 1.2 | 10 |
| Swallow | 2/3/20 | B | 7.81 | 20.7 | 5.1 | 69 | 51,174 | 33.7 | | | | | | | | |
| Swallow | 4/14/20 | S | 7.92 | 28.8 | 6.6 | 104 | 54,630 | 36.1 | 13 | 694 | 707 | 40 | 4.9 | 2.8 | 1.2 | 10 |
| Swallow | 4/14/20 | B | 7.80 | 28.4 | 4.1 | 64 | 54,952 | 36.3 | | | | | | | | |
| Swallow | 5/14/20 | S | 7.91 | 25.8 | 5.5 | 82 | 51,897 | 34.1 | 33 | 460 | 493 | 88 | 3.5 | 2.3 | 1.4 | 10 |
| Swallow | 5/14/20 | B | 7.92 | 25.7 | 4.2 | 64 | 54,230 | 35.8 | | | | | | | | |
| Swallow | 6/15/20 | S | 7.58 | 31.0 | 1.7 | 26 | 49,504 | 32.2 | 28 | 863 | 891 | 102 | 4.1 | 5.5 | 0.8 | 668 |
| Swallow | 7/28/20 | S | 7.87 | 30.8 | 6.2 | 97 | 46,706 | 30.2 | 28 | 638 | 666 | 56 | 4.7 | 1.6 | 2.1 | 41 |
| Swallow | 7/28/20 | B | 8.18 | 31.0 | 9.7 | 156 | 52,277 | 34.2 | | | | | | | | |
| Swallow | 8/25/20 | S | 8.00 | 29.7 | 6.3 | 98 | 47,398 | 30.7 | 11 | 675 | 686 | 42 | 5.2 | 1.3 | 1.8 | 121 |
| Swallow | 8/25/20 | B | 7.90 | 31.5 | 3.8 | 63 | 51,196 | 33.4 | | | | | | | | |
| Swallow | 9/23/20 | S | 8.02 | 28.9 | 5.6 | 85 | 44,349 | 28.5 | 14 | 1,070 | 1,084 | 125 | 173.0 | 6.9 | 1.3 | 10 |
| Swallow | 9/23/20 | B | 7.72 | 30.2 | 1.0 | | 50,733 | 33.1 | | | | | | | | |
| Swallow | 10/22/20 | S | | | | | | | | | | 5 | 4.0 | | 1.3 | 50 |
| Swallow | 11/23/20 | S | 7.94 | 25.2 | 2.8 | 38 | 49,036 | 32.0 | 60 | 300 | 360 | 32 | 2.5 | 0.98 | 2 | 110 |
| Swallow | 11/23/20 | B | | | | | | | | | | 32 | 2.5 | | | |
| Swallow | 12/10/20 | S | 8.12 | 20.6 | 3.7 | 49 | 49,169 | 32.3 | 46 | 440 | 486 | 37 | 2.5 | 1.1 | 1.5 | 10 |
| Swallow | 12/10/20 | B | | | | | | | | | 480 | 37 | 2.5 | | | 10 |

Historical Water Quality Data for Marco Island Monitoring Sites from 2007 - 2020

| Station ID | Sample Date | Sample Depth | pH (s.u.) | Temp. (°C) | Diss. O ₂ (mg/L) | Diss. O ₂ (% satm.) | Cond. (µmho/cm) | Salinity (ppt) | NOx (µg/L) | TKN (µg/L) | Total N (µg/L) | Total P (µg/L) | Chl-a (mg/m ³) | Turbidity (NTU) | Secchi Depth (m) | Entero (cfu/100 mL) |
|----------------------|-------------|--------------|-----------|------------|-----------------------------|--------------------------------|-----------------|----------------|------------|------------|----------------|----------------|----------------------------|-----------------|------------------|---------------------|
| W Winterberry Bridge | 1/28/15 | S | 7.88 | 19.4 | 7.3 | 97 | 52,938 | 35.0 | 23 | | | | | | 1.1 | |
| W Winterberry Bridge | 5/12/15 | S | 7.99 | 29.0 | 6.5 | 102 | 52,695 | 34.6 | 19 | 303 | 322 | | | | 1.3 | |
| W Winterberry Bridge | 8/25/15 | S | 7.98 | 32.4 | 5.6 | 93 | 51,698 | 33.8 | 15 | 662 | 677 | | | | 2.2 | |
| W Winterberry Bridge | 11/19/15 | S | 7.85 | 26.9 | 6.8 | 103 | 51,768 | 34.0 | | | | | | | 2.8 | |
| W Winterberry Bridge | 2/1/16 | S | 7.85 | 19.3 | 6.7 | 87 | 45,374 | 29.4 | 71 | 275 | 346 | | | | 2.4 | |
| W Winterberry Bridge | 5/10/16 | S | 7.86 | 25.9 | 5.9 | 88 | 52,211 | 34.3 | 11 | | | | | | 1.8 | |
| W Winterberry Bridge | 8/11/16 | S | 7.96 | 31.1 | 6.1 | 96 | 47,466 | 30.7 | 4 | 569 | 573 | | | | | |
| W Winterberry Bridge | 11/9/16 | S | 7.91 | 24.1 | 6.4 | 92 | 53,353 | 35.2 | | | | | | | | |
| W Winterberry Bridge | 2/21/17 | S | 7.89 | 23.2 | 6.5 | 92 | 52,963 | 35.0 | | | | | | | 2.2 | |
| W Winterberry Bridge | 5/18/17 | S | 7.88 | 29.0 | 6.0 | 95 | 54,168 | 35.7 | 6 | 589 | 595 | 14 | 3.9 | | 1.2 | 10 |
| W Winterberry Bridge | 8/18/17 | B | 7.88 | 28.7 | 5.3 | 83 | 54,895 | 36.3 | | | | | | | 1.2 | |
| W Winterberry Bridge | 8/16/17 | S | 8.08 | 33.5 | 6.1 | 101 | 47,888 | 30.9 | 2 | 311 | 313 | 344 | 5.4 | | 1.2 | 41 |
| W Winterberry Bridge | 11/13/17 | S | 7.91 | 24.9 | 5.5 | 80 | 51,873 | 34.1 | 20 | 623 | 643 | 27 | 3.4 | | 1.8 | 10 |
| W Winterberry Bridge | 11/13/17 | B | 7.91 | 24.7 | 4.8 | 70 | 52,130 | 34.3 | | | | | | | | |
| W Winterberry Bridge | 2/8/18 | S | 7.91 | 22.1 | 7.1 | 98 | 53,490 | 35.4 | | 290 | 792 | 7 | 2.3 | | 1.7 | 10 |
| W Winterberry Bridge | 5/21/18 | S | 7.87 | 26.6 | 6.7 | 101 | 51,505 | 33.8 | 11 | 781 | 792 | 19 | 4.4 | | 2.4 | 10 |
| W Winterberry Bridge | 5/21/18 | B | 7.81 | 26.5 | 5.9 | 88 | 52,154 | 34.3 | | | | | | | | |
| W Winterberry Bridge | 8/16/18 | S | 7.96 | 31.2 | 5.9 | 96 | 52,615 | 34.5 | 11 | 834 | 845 | 64 | 5.3 | | 1.8 | 52 |
| W Winterberry Bridge | 8/16/18 | B | 7.95 | 31.2 | 5.7 | 93 | 52,693 | 34.5 | | | | | | | | |
| W Winterberry Bridge | 11/15/18 | S | 7.90 | 27.2 | 5.3 | 81 | 52,488 | 34.5 | 11 | 967 | 978 | 71 | 8.3 | | 1.3 | 74 |
| W Winterberry Bridge | 11/15/18 | B | 7.90 | 27.3 | 5.2 | 80 | 52,493 | 34.5 | | | | | | | | |
| W Winterberry Bridge | 2/26/19 | S | 7.85 | 25.9 | 5.8 | 85 | 51,737 | 34.0 | 11 | 388 | 399 | 62 | 3.5 | | 1.0 | 10 |
| W Winterberry Bridge | 2/26/19 | B | 7.85 | 25.7 | 5.3 | 78 | 51,900 | 34.1 | | | | | | | | |
| W Winterberry Bridge | 5/13/19 | S | 7.87 | 29.9 | 6.4 | 103 | 53,384 | 35.1 | 16 | 1,020 | 1,036 | 53 | 5.5 | | 1.3 | 10 |
| W Winterberry Bridge | 5/13/19 | B | 7.86 | 29.6 | 5.3 | 84 | 53,486 | 35.2 | | | | | | | | |
| W Winterberry Bridge | 8/7/19 | S | 8.00 | 30.9 | 6.8 | 108 | 47,139 | 30.5 | 11 | 668 | 679 | 70 | 6.4 | | 1.6 | 10 |
| W Winterberry Bridge | 8/7/19 | B | 7.90 | 30.8 | 4.9 | 79 | 49,784 | 32.4 | | | | | | | | |
| W Winterberry Bridge | 10/23/19 | S | 7.91 | 29.6 | 5.7 | 90 | 52,613 | 34.5 | | | | | | | 1.4 | |
| W Winterberry Bridge | 11/4/19 | S | 7.85 | 28.8 | 4.7 | 73 | 51,015 | 33.4 | 15 | 757 | 772 | 76 | 6.6 | | 0.7 | 10 |
| W Winterberry Bridge | 12/18/19 | S | 7.96 | 23.9 | 6.6 | 95 | 49,928 | 32.7 | 19 | 537 | 556 | 58 | 2.2 | | 2.2 | 733 |
| W Winterberry Bridge | 12/18/19 | B | 7.95 | 23.9 | 6.5 | 94 | 50,446 | 33.1 | | | | | | | | |
| W Winterberry Bridge | 1/15/20 | S | 7.84 | 22.8 | 6.2 | 87 | 51,353 | 33.8 | 35 | 540 | 575 | 78 | 4.4 | | 1.3 | 10 |
| W Winterberry Bridge | 1/15/20 | B | 7.87 | 22.8 | 6.3 | 89 | 51,478 | 33.9 | | | | | | | | |
| W Winterberry Bridge | 2/3/20 | S | 7.83 | 19.4 | 6.4 | 84 | 50,764 | 33.4 | 16 | 701 | 717 | 21 | 1.2 | | 1.4 | 10 |
| W Winterberry Bridge | 2/3/20 | B | 7.86 | 19.1 | 6.4 | 84 | 51,041 | 33.6 | | | | | | | | |
| W Winterberry Bridge | 4/14/20 | S | 7.82 | 28.3 | 5.6 | 87 | 55,185 | 36.5 | 11 | 561 | 572 | 55 | 3.0 | | 1.5 | 10 |
| W Winterberry Bridge | 4/14/20 | B | 7.81 | 28.3 | 5.1 | 81 | 55,256 | 36.5 | | | | | | | | |
| W Winterberry Bridge | 5/14/20 | S | 7.94 | 25.8 | 5.8 | 87 | 54,598 | 36.1 | 33 | 430 | 463 | 92 | 1.7 | | 1.1 | 10 |
| W Winterberry Bridge | 6/15/20 | S | 7.95 | 30.1 | 6.4 | 101 | 49,609 | 32.3 | 11 | 2,180 | 2,191 | 43 | 4.5 | | 1.6 | 10 |
| W Winterberry Bridge | 6/15/20 | B | 7.92 | 29.8 | 5.0 | 79 | 53,055 | 34.9 | | | | | | | | |
| W Winterberry Bridge | 7/28/20 | S | 8.07 | 30.9 | 7.1 | 112 | 49,639 | 32.3 | 11 | 606 | 617 | 47 | 5.4 | | 1.5 | 10 |
| W Winterberry Bridge | 8/25/20 | S | 7.99 | 30.8 | 5.3 | 86 | 50,684 | 33.1 | 11 | 573 | 584 | 30 | 7.8 | | 2.0 | 10 |
| W Winterberry Bridge | 8/25/20 | B | 7.98 | 30.8 | 4.9 | 79 | 50,715 | 33.1 | | | | | | | | |
| W Winterberry Bridge | 9/23/20 | S | 7.95 | 29.2 | 5.9 | 91 | 46,885 | 30.5 | 11 | 792 | 803 | 38 | 5.1 | | 2 | 10 |
| W Winterberry Bridge | 9/23/20 | B | 7.92 | 29.7 | 4.8 | 74 | 48,607 | 31.6 | | | | | | | 2 | |
| W Winterberry Bridge | 10/22/20 | S | | | | | | | | | | | | | | |
| W Winterberry Bridge | 11/23/20 | S | 8.21 | 24.8 | 4.1 | 59 | 49,502 | 32.3 | 74 | 280 | 354 | 20 | 2.5 | | 1.6 | 50 |
| W Winterberry Bridge | 11/23/20 | B | | | | | | | | | | | | | | |
| W Winterberry Bridge | 12/10/20 | S | 8.18 | 19.8 | 5.2 | 66 | 50,249 | 33.0 | 39 | 350 | 389 | <5 | 2.5 | | 1.6 | 10 |
| W Winterberry Bridge | 12/10/20 | B | | | | | | | | | | 5 | 2.5 | | | 10 |

Historical Water Quality Data for Marco Island Monitoring Sites from 2007 - 2020

| Station ID | Sample Date | Sample Depth | pH (s.u.) | Temp. (°C) | Diss. O ₂ (mg/L) | Diss. O ₂ (% satm.) | Cond. (µmho/cm) | Salinity (ppt) | NOx (µg/L) | TKN (µg/L) | Total N (µg/L) | Total P (µg/L) | Chl-a (mg/m ³) | Turbidity (NTU) | Secchi Depth (m) | Entero (cfu/100 mL) |
|------------|-------------|--------------|-----------|------------|-----------------------------|--------------------------------|-----------------|----------------|------------|------------|----------------|----------------|----------------------------|-----------------|------------------|---------------------|
| Windmill | 2/21/17 | S | 7.68 | 23.5 | 6.1 | 87 | 52,949 | 35.0 | 2 | 575 | 577 | 24 | 3.1 | | 2.2 | |
| Windmill | 2/21/17 | B | 7.73 | 23.5 | 6.0 | 86 | 53,159 | 35.1 | | | | | | | 2.2 | |
| Windmill | 5/18/17 | S | 7.72 | 28.5 | 4.6 | 75 | 55,033 | 36.4 | 6 | 575 | 581 | 40 | 5.9 | | 1.1 | 10 |
| Windmill | 5/18/17 | B | 7.73 | 28.3 | 4.8 | 71 | 55,408 | 36.7 | | | | | | | 1.1 | |
| Windmill | 8/16/17 | S | 7.99 | 33.0 | 5.4 | 87 | 44,654 | 28.6 | 3 | 575 | 578 | 14 | 4.9 | | 2.0 | 20 |
| Windmill | 8/16/17 | B | 7.98 | 33.0 | 4.9 | 80 | 45,811 | 29.5 | | | | | | | | |
| Windmill | 11/13/17 | S | 7.78 | 24.9 | 6.2 | 89 | 49,452 | 32.3 | 6 | 353 | 359 | 39 | 3.8 | | 1.6 | 20 |
| Windmill | 11/13/17 | B | 7.89 | 24.7 | 5.8 | 84 | 50,591 | 33.2 | | | | | | | | |
| Windmill | 2/8/18 | S | 7.76 | 22.5 | 6.7 | 94 | 53,536 | 35.4 | | 231 | | 8 | 2.8 | | 1.5 | 10 |
| Windmill | 2/8/18 | B | 7.78 | 22.6 | 6.2 | 87 | 54,118 | 35.8 | | | | | | | | |
| Windmill | 5/21/18 | S | 7.48 | 26.1 | 4.7 | 70 | 49,878 | 32.6 | 16 | 1,210 | 1,226 | 61 | 5.6 | | 1.4 | 74 |
| Windmill | 5/21/18 | B | 7.57 | 25.9 | 4.8 | 71 | 51,239 | 33.6 | | | | | | | | |
| Windmill | 8/16/18 | S | 8.07 | 30.8 | 5.8 | 93 | 51,327 | 33.5 | 11 | 595 | 606 | 84 | 9.6 | | 1.8 | 63 |
| Windmill | 8/16/18 | B | 8.05 | 30.5 | 5.1 | 81 | 51,624 | 33.8 | | | | | | | | |
| Windmill | 11/15/18 | S | 7.78 | 27.4 | 5.3 | 81 | 52,186 | 34.3 | 11 | 1,170 | 1,181 | 78 | 5.5 | | 1.1 | 488 |
| Windmill | 11/15/18 | B | 7.81 | 27.5 | 4.7 | 73 | 53,249 | 35.1 | | | | | | | | |
| Windmill | 2/26/19 | S | 7.85 | 25.8 | 6.0 | 88 | 51,272 | 33.7 | 11 | 324 | 335 | 73 | 7.6 | | 1.0 | 10 |
| Windmill | 2/26/19 | B | 7.83 | 25.8 | 5.5 | 80 | 51,692 | 34.0 | | | | | | | | |
| Windmill | 5/13/19 | S | 7.82 | 29.3 | 5.6 | 89 | 53,216 | 35.0 | 11 | 230 | 241 | 64 | 5.7 | | 1.2 | 450 |
| Windmill | 5/13/19 | B | 7.84 | 29.2 | 5.4 | 86 | 53,249 | 35.0 | | | | | | | | |
| Windmill | 8/7/19 | S | 7.78 | 30.4 | 4.7 | 74 | 46,308 | 29.9 | 11 | 665 | 676 | 84 | 6.8 | | 1.8 | 10 |
| Windmill | 8/7/19 | B | 7.79 | 30.3 | 4.6 | 72 | 46,763 | 30.2 | | | | | | | | |
| Windmill | 10/23/19 | S | 7.78 | 29.7 | 5.6 | 88 | 51,830 | 34.0 | | | | | | | | |
| Windmill | 10/23/19 | B | 7.75 | 29.5 | 5.0 | 79 | 51,964 | 34.1 | | | | | | | | |
| Windmill | 11/4/19 | S | 7.86 | 29.5 | 5.9 | 93 | 50,204 | 32.8 | 11 | 819 | 830 | 76 | 11.3 | | 1.2 | 10 |
| Windmill | 11/4/19 | B | 7.87 | 29.5 | 5.8 | 91 | 50,205 | 32.8 | | | | | | | | |
| Windmill | 12/18/19 | S | 7.78 | 23.5 | 7.0 | 97 | 46,295 | 30.1 | 11 | 511 | 522 | 58 | 5.0 | | 1.2 | 4,106 |
| Windmill | 12/18/19 | B | 7.82 | 24.4 | 6.0 | 88 | 52,665 | 34.7 | | | | | | | | |
| Windmill | 1/15/20 | S | 7.78 | 23.3 | 6.3 | 88 | 50,835 | 33.4 | 11 | 543 | 554 | 47 | 4.7 | | 1.2 | 10 |
| Windmill | 1/15/20 | B | 7.79 | 23.3 | 6.0 | 85 | 51,155 | 33.6 | | | | | | | | |
| Windmill | 2/3/20 | S | 7.67 | 18.7 | 6.5 | 84 | 50,585 | 33.2 | 12 | 689 | 701 | 29 | 2.3 | | 1.3 | 10 |
| Windmill | 2/3/20 | B | 7.71 | 18.7 | 6.5 | 84 | 50,762 | 33.4 | | | | | | | | |
| Windmill | 4/14/20 | S | 7.75 | 28.7 | 5.3 | 84 | 55,265 | 36.5 | 11 | 796 | 807 | 48 | 5.7 | | 1.3 | 10 |
| Windmill | 4/14/20 | B | 7.74 | 28.6 | 5.2 | 82 | 55,412 | 36.7 | | | | | | | | |
| Windmill | 5/14/20 | S | 7.91 | 25.7 | 5.8 | 87 | 54,776 | 36.3 | 33 | 480 | 513 | 110 | 3.7 | | 0.8 | 10 |
| Windmill | 5/14/20 | B | 7.92 | 25.7 | 5.8 | 87 | 54,805 | 36.3 | | | | | | | | |
| Windmill | 6/15/20 | S | 7.79 | 31.0 | 7.5 | 119 | 48,432 | 31.4 | 11 | 967 | 978 | 57 | 10.3 | | 1.0 | 10 |
| Windmill | 6/15/20 | B | 7.76 | 30.3 | 5.5 | 87 | 50,250 | 32.8 | | | | | | | | |
| Windmill | 7/28/20 | S | 7.87 | 30.3 | 5.6 | 88 | 47,776 | 31.0 | 11 | 767 | 778 | 59 | 5.5 | | 1.5 | 10 |
| Windmill | 7/28/20 | B | 7.90 | 30.3 | 5.2 | 82 | 50,372 | 32.9 | | | | | | | | |
| Windmill | 8/25/20 | S | 7.83 | 30.4 | 5.3 | 84 | 49,212 | 32.0 | 11 | 777 | 788 | 29 | 4.8 | | 1.6 | 10 |
| Windmill | 8/25/20 | B | 7.86 | 30.4 | 5.1 | 81 | 49,744 | 32.4 | | | | | | | | |
| Windmill | 9/23/20 | S | 7.93 | 28.8 | 6.5 | 98 | 42,133 | 27.0 | 11 | 319 | 330 | 41 | 7.6 | | 1.7 | 20 |
| Windmill | 9/23/20 | B | 7.89 | 28.7 | 5.0 | 77 | 47,827 | 31.1 | | | | | | | | |
| Windmill | 10/22/20 | S | | | | | | | | | | | | | | |
| Windmill | 11/23/20 | S | 8.16 | 27.8 | 3.9 | 57 | 49,001 | 32.2 | 42 | 390 | 400 | 5 | 6.4 | | 1.7 | 50 |
| Windmill | 11/23/20 | B | | | | | | | | | | | | | | |
| Windmill | 12/10/20 | S | 8.29 | 19.3 | 4.7 | 60 | 48,274 | 32.3 | 10 | 390 | 400 | 5 | 4.0 | | 1.5 | 20 |
| Windmill | 12/10/20 | B | | | | | | | | | | | | | | |
| Windmill | 12/10/20 | S | | | | | | | | | | | | | | |
| Windmill | 12/10/20 | B | | | | | | | | | | | | | | |

Questionable value, not included in data analysis

Measured value less than MDL; listed value = MDL

A-2: Mean Annual Values for Marco Island Monitoring Sites

Annual Geometric Mean Values for Historical Marco Island Monitoring Sites from 2007 -2020

| Sample Site | Year | pH (s.u.) | Temp. (°C) | Diss. O ₂ (mg/L) | Diss. O ₂ (% satn.) | Cond. (µmho/cm) | Salinity (ppt) | NOx (µg/L) | TKN (µg/L) | Total N (µg/L) | Total P (µg/L) | Chyl-a (mg/m ³) | Turbidity (NTU) | Secchi Depth (m) | Entero (cfu/100 mL) |
|----------------------|------|-----------|------------|-----------------------------|--------------------------------|-----------------|----------------|------------|------------|----------------|----------------|-----------------------------|-----------------|------------------|---------------------|
| Barfield Bridge | 2007 | - | - | - | - | - | - | - | 540 | - | - | - | - | - | 4 |
| | 2008 | - | - | - | - | - | - | - | 273 | - | - | - | - | - | 5 |
| | 2009 | - | - | - | - | - | - | - | 247 | - | - | - | - | - | 2 |
| | 2010 | - | - | - | - | - | - | - | 399 | - | - | - | - | - | 4 |
| | 2011 | - | - | - | - | - | - | - | 395 | - | - | - | - | - | 3 |
| | 2012 | - | - | - | - | - | - | - | 374 | - | - | - | - | - | 7 |
| | 2013 | - | - | - | - | - | - | - | 350 | - | - | - | - | - | 63 |
| | 2014 | - | - | - | - | - | - | - | 274 | - | - | - | - | - | 27 |
| | 2015 | 7.82 | 25.76 | 5.9 | 89 | 51,729 | 34.0 | 25 | 280 | 305 | 27 | - | 3.2 | 1.62 | 26 |
| | 2016 | 7.84 | 24.15 | 6.5 | 93 | 48,751 | 31.8 | 29 | 395 | 424 | - | - | - | 1.80 | - |
| | 2017 | 7.88 | 27.45 | 6.0 | 91 | 51,114 | 33.5 | 2 | 538 | 540 | 21 | 2.4 | - | 1.77 | 5 |
| | 2018 | 7.87 | 26.22 | 6.0 | 90 | 51,595 | 33.9 | 45 | 479 | 524 | 43 | 4.4 | - | 1.63 | 92 |
| 2019 | 7.84 | 27.87 | 6.3 | 96 | 50,949 | 33.4 | 11 | 545 | 556 | 73 | 6.6 | 6.2 | 1.27 | 17 | |
| 2020 | 7.91 | 25.60 | 5.9 | 87 | 51,504 | 33.8 | 14 | 572 | 586 | 39 | 3.7 | 3.2 | 1.48 | 12 | |
| Collier Bridge | 2007 | - | - | - | - | - | - | - | 580 | - | - | - | - | - | 9 |
| | 2008 | - | - | - | - | - | - | - | 417 | - | - | - | - | - | 3 |
| | 2009 | - | - | - | - | - | - | - | 423 | - | - | - | - | - | 2 |
| | 2010 | - | - | - | - | - | - | - | 181 | - | - | - | - | - | 2 |
| | 2011 | - | - | - | - | - | - | - | 385 | - | - | - | - | - | 4 |
| | 2012 | - | - | - | - | - | - | - | 371 | - | - | - | - | - | 13 |
| | 2013 | - | - | - | - | - | - | - | 389 | - | - | - | - | - | 149 |
| | 2014 | - | - | - | - | - | - | - | 299 | - | - | - | - | - | 29 |
| | 2015 | 7.77 | 26.72 | 5.0 | 76 | 50,336 | 32.9 | 36 | 233 | 268 | 31 | 3.0 | - | 1.47 | 21 |
| | 2016 | 7.76 | 24.98 | 5.3 | 77 | 48,004 | 31.2 | 31 | 415 | 446 | - | - | - | 1.97 | - |
| | 2017 | 7.86 | 28.68 | 5.8 | 89 | 48,471 | 31.5 | 3 | 489 | 492 | 27 | 3.7 | - | 1.83 | 10 |
| | 2018 | 7.83 | 28.24 | 6.4 | 97 | 48,048 | 31.2 | 19 | 517 | 536 | 72 | 2.7 | 3.3 | 1.45 | 91 |
| 2019 | 7.89 | 26.83 | 5.0 | 75 | 48,847 | 31.7 | 16 | 502 | 518 | 32 | 3.0 | 1.7 | 1.76 | 16 | |
| 2020 | 7.89 | 26.83 | 5.0 | 75 | 48,847 | 31.7 | 16 | 502 | 518 | 47 | 3.0 | 1.7 | 1.76 | 16 | |
| E Winterberry Bridge | 2015 | 7.92 | 26.43 | 6.1 | 92 | 52,327 | 34.4 | 26 | 689 | 715 | - | - | - | 1.51 | - |
| | 2016 | 7.92 | 24.60 | 6.0 | 86 | 50,488 | 33.1 | 15 | 745 | 760 | - | - | - | - | - |
| | 2017 | 7.90 | 26.79 | 6.1 | 92 | 51,722 | 33.9 | 3 | 332 | 335 | 20 | 4.2 | - | 1.61 | 10 |
| | 2018 | 7.90 | 26.68 | 5.7 | 86 | 52,411 | 34.5 | 15 | 651 | 666 | 44 | 6.4 | - | 1.43 | 43 |
| | 2019 | 7.87 | 28.34 | 5.9 | 92 | 50,794 | 33.2 | 16 | 651 | 667 | 64 | 5.7 | 3.1 | 1.41 | 29 |
| | 2020 | 7.96 | 26.37 | 5.8 | 88 | 51,054 | 33.5 | 16 | 614 | 630 | 33 | 3.7 | 2.5 | 1.64 | 12 |

Annual Geometric Mean Values for Historical Marco Island Monitoring Sites from 2007 -2020

| Sample Site | Year | pH (s.u.) | Temp. (°C) | Diss. O ₂ (mg/L) | Diss. O ₂ (% satn.) | Cond. (µmho/cm) | Salinity (ppt) | NOx (µg/L) | TKN (µg/L) | Total N (µg/L) | Total P (µg/L) | Cnvl-a (mg/m ³) | Turbidity (NTU) | Secchi Depth (m) | Entero (cfu/100 mL) |
|-------------|------|-----------|------------|-----------------------------|--------------------------------|-----------------|----------------|------------|------------|----------------|----------------|-----------------------------|-----------------|------------------|---------------------|
| HC Center | 2007 | - | - | - | - | - | - | - | 550 | - | - | - | - | - | 3 |
| | 2008 | - | - | - | - | - | - | - | 337 | - | - | - | - | - | 2 |
| | 2009 | - | - | - | - | - | - | - | 387 | - | - | - | - | - | 2 |
| | 2010 | - | - | - | - | - | - | - | 171 | - | - | - | - | - | 2 |
| | 2011 | - | - | - | - | - | - | - | 336 | - | - | - | - | - | 3 |
| | 2012 | - | - | - | - | - | - | - | 336 | - | - | - | - | - | 3 |
| | 2013 | - | - | - | - | - | - | - | 244 | - | - | - | - | - | 15 |
| | 2014 | - | - | - | - | - | - | - | 260 | - | - | - | - | - | 18 |
| | 2015 | 7.80 | 27.06 | 5.3 | 81 | 50,280 | 32.9 | 25 | 205 | 229 | 24 | 2.5 | - | - | 10 |
| | 2016 | 7.83 | 24.93 | 5.7 | 83 | 48,197 | 31.4 | 33 | 460 | 493 | - | - | - | - | - |
| | 2017 | 7.79 | 27.78 | 5.7 | 86 | 49,320 | 32.2 | 3 | 533 | 536 | 28 | 3.8 | - | 1.81 | 13 |
| 2018 | 7.81 | 26.62 | 5.9 | 88 | 51,158 | 33.5 | 12 | 840 | 852 | 22 | 3.6 | - | 1.85 | 32 | |
| 2019 | 7.88 | 28.42 | 7.1 | 109 | 48,772 | 31.7 | 11 | 461 | 472 | 54 | 7.0 | - | 1.30 | 27 | |
| 2020 | 7.86 | 25.92 | 5.4 | 79 | 48,904 | 31.9 | 20 | 488 | 508 | 48 | 3.7 | - | 1.70 | 12 | |
| Hollyhock | 2007 | - | - | - | - | - | - | - | 624 | - | - | - | - | - | 23 |
| | 2008 | - | - | - | - | - | - | - | 395 | - | - | - | - | - | 4 |
| | 2009 | - | - | - | - | - | - | - | 238 | - | - | - | - | - | 4 |
| | 2010 | - | - | - | - | - | - | - | 221 | - | - | - | - | - | 5 |
| | 2011 | - | - | - | - | - | - | - | 521 | - | - | - | - | - | 8 |
| | 2012 | - | - | - | - | - | - | - | 390 | - | - | - | - | - | 8 |
| | 2013 | - | - | - | - | - | - | - | 413 | - | - | - | - | - | 66 |
| | 2014 | - | - | - | - | - | - | - | 358 | - | - | - | - | - | 31 |
| | 2015 | 7.80 | 26.08 | 6.0 | 91 | 51,851 | 34.0 | 23 | 168 | 191 | 26 | 3.7 | - | - | 14 |
| | 2016 | 7.76 | 24.44 | 5.0 | 72 | 47,856 | 31.2 | 31 | 503 | 534 | - | - | - | 0.90 | - |
| | 2017 | 7.80 | 27.24 | 5.6 | 86 | 50,366 | 32.9 | 6 | 510 | 515 | 31 | 3.9 | - | 1.32 | 24 |
| 2018 | 7.74 | 26.62 | 4.6 | 70 | 51,944 | 34.1 | 21 | 646 | 667 | 41 | 3.6 | - | 1.19 | 30 | |
| 2019 | 7.70 | 28.08 | 5.0 | 76 | 50,789 | 33.2 | 27 | 601 | 627 | 74 | 10.5 | - | 1.31 | 24 | |
| 2020 | 7.86 | 25.82 | 5.2 | 77 | 50,587 | 33.1 | 16 | 572 | 588 | 42 | 4.3 | - | 1.38 | 18 | |
| Hummingbird | 2007 | - | - | - | - | - | - | - | 566 | - | - | - | - | - | 4 |
| | 2008 | - | - | - | - | - | - | - | 292 | - | - | - | - | - | 2 |
| | 2009 | - | - | - | - | - | - | - | 409 | - | - | - | - | - | 3 |
| | 2010 | - | - | - | - | - | - | - | 464 | - | - | - | - | - | 3 |
| | 2011 | - | - | - | - | - | - | - | 440 | - | - | - | - | - | 7 |
| | 2012 | - | - | - | - | - | - | - | 449 | - | - | - | - | - | 7 |
| | 2013 | - | - | - | - | - | - | - | 407 | - | - | - | - | - | 31 |
| | 2014 | - | - | - | - | - | - | - | 268 | - | - | - | - | - | 24 |
| | 2015 | 7.80 | 26.69 | 5.6 | 85 | 51,188.36 | 33.5 | 24 | 175 | 198 | 26 | 3.7 | - | - | 14 |
| | 2016 | 7.90 | 24.58 | 6.7 | 95 | 46,653 | 30.3 | 20 | 527 | 547 | - | - | - | - | - |
| | 2017 | 7.85 | 28.49 | 6.0 | 93 | 49,854 | 32.5 | 4 | 506 | 511 | 25 | 5.1 | - | 1.40 | 10 |
| 2018 | 7.76 | 28.44 | 4.8 | 74 | 51,239 | 33.6 | 13 | 961 | 974 | 70 | 6.9 | - | 1.15 | 79 | |
| 2019 | 7.77 | 28.28 | 5.7 | 87 | 49,869 | 32.5 | 13 | 602 | 615 | 75 | 8.1 | - | 1.33 | 54 | |
| 2020 | 7.88 | 25.94 | 5.6 | 83 | 48,946 | 31.9 | 18 | 551 | 570 | 33 | 3.9 | - | 1.43 | 13 | |

Annual Geometric Mean Values for Historical Marco Island Monitoring Sites from 2007 -2020

| Sample Site | Year | pH (s.u.) | Temp. (°C) | Diss. O ₂ (mg/L) | Diss. O ₂ (% satn.) | Cond. (µmho/cm) | Salinity (ppt) | NOx (µg/L) | TKN (µg/L) | Total N (µg/L) | Total P (µg/L) | CNyl-a (mg/m ³) | Turbidity (NTU) | Secchi Depth (m) | Entero (cfu/100 mL) |
|-------------|------|-----------|------------|-----------------------------|--------------------------------|-----------------|----------------|------------|------------|----------------|----------------|-----------------------------|-----------------|------------------|---------------------|
| JH Park | 2007 | - | - | - | - | - | - | - | 524 | - | - | - | - | - | 3 |
| | 2008 | - | - | - | - | - | - | - | 347 | - | - | - | - | - | 3 |
| | 2009 | - | - | - | - | - | - | - | 494 | - | - | - | - | - | 3 |
| | 2010 | - | - | - | - | - | - | - | 236 | - | - | - | - | - | 2 |
| | 2011 | - | - | - | - | - | - | - | 409 | - | - | - | - | - | 3 |
| | 2012 | - | - | - | - | - | - | - | 370 | - | - | - | - | - | 3 |
| | 2013 | - | - | - | - | - | - | - | 369 | - | - | - | - | - | 46 |
| | 2014 | - | - | - | - | - | - | - | 303 | - | - | - | - | - | 17 |
| | 2015 | 7.74 | 26.30 | 5.6 | 84 | 50,376 | 32.9 | 27 | 188 | 215 | 22 | 2.9 | - | 1.33 | 20 |
| | 2016 | 7.80 | 24.56 | 6.0 | 86 | 48,122 | 31.3 | 39 | 477 | 516 | - | - | - | 1.63 | - |
| | 2017 | 7.85 | 27.57 | 5.9 | 90 | 50,270 | 32.9 | 2 | 580 | 582 | 26 | 4.1 | - | 1.43 | 13 |
| | 2018 | 7.80 | 26.73 | 5.3 | 80 | 51,738 | 34.0 | 15 | 638 | 652 | 33 | 3.5 | - | 2.18 | 76 |
| 2019 | 7.79 | 28.14 | 5.7 | 88 | 50,308 | 32.9 | 12 | 571 | 583 | 65 | 6.3 | 4.1 | 1.35 | 31 | |
| 2020 | 7.91 | 25.82 | 5.6 | 83 | 49,875 | 32.6 | 17 | 498 | 515 | 41 | 3.5 | 2.1 | 1.63 | 13 | |
| Kendall | 2015 | 7.83 | 26.27 | 5.5 | 82 | 51,003 | 33.4 | 26 | 289 | 315 | - | - | - | 1.57 | - |
| | 2016 | 7.78 | 24.68 | 6.0 | 86 | 47,648 | 31.0 | 60 | 413 | 472 | - | - | - | 2.30 | - |
| | 2017 | 7.81 | 27.43 | 5.6 | 86 | 50,486 | 33.0 | 3 | 641 | 643 | 33 | 3.5 | - | 1.21 | 10 |
| | 2018 | 7.81 | 26.78 | 5.4 | 81 | 51,747 | 34.0 | 13 | 542 | 555 | 36 | 2.7 | - | 0.95 | 65 |
| | 2019 | 7.77 | 28.20 | 5.2 | 80 | 50,326 | 32.9 | 16 | 637 | 652 | 71 | 6.0 | 5.6 | 0.87 | 23 |
| | 2020 | 7.88 | 26.45 | 5.3 | 78 | 49,521 | 32.3 | 16 | 645 | 660 | 41 | 3.2 | 2.7 | 1.06 | 12 |
| Landmark | 2019 | 7.68 | 27.56 | 5.2 | 80 | 52,036 | 34.2 | 11 | 820 | 831 | 81 | 8.6 | 1.9 | 1.69 | 41 |
| | 2020 | 8.01 | 25.76 | 5.8 | 85 | 49,434 | 32.3 | 15 | 548 | 563 | 68 | 3.5 | 1.0 | 1.88 | 23 |
| McIlvaine | 2007 | - | - | - | - | - | - | - | 504 | - | - | - | - | - | 5 |
| | 2008 | - | - | - | - | - | - | - | 308 | - | - | - | - | - | 3 |
| | 2009 | - | - | - | - | - | - | - | 323 | - | - | - | - | - | 3 |
| | 2010 | - | - | - | - | - | - | - | 252 | - | - | - | - | - | 2 |
| | 2011 | - | - | - | - | - | - | - | 352 | - | - | - | - | - | 4 |
| | 2012 | - | - | - | - | - | - | - | 306 | - | - | - | - | - | 4 |
| | 2013 | - | - | - | - | - | - | - | 284 | - | - | - | - | - | 12 |
| | 2014 | - | - | - | - | - | - | - | 261 | - | - | - | - | - | 22 |
| | 2015 | 7.98 | 25.64 | 6.6 | 99 | 52,748 | 34.7 | 17 | 312 | 329 | 28 | 3.6 | - | 1.18 | 10 |
| | 2016 | 7.99 | 23.76 | 6.6 | 94 | 50,563 | 33.2 | 9 | 462 | 471 | - | - | - | 1.22 | - |
| | 2017 | - | - | - | - | - | - | - | - | - | - | - | - | - | - |
| | 2018 | 7.95 | 25.70 | 6.0 | 89 | 53,727 | 35.4 | 13 | 475 | 488 | 44 | 2.7 | - | 1.28 | 39 |
| 2019 | - | - | - | - | - | - | - | - | - | 60 | 4.1 | - | - | - | |
| 2020 | 8.16 | 23.93 | 4.8 | 67 | 50,563 | 33.0 | 22 | 335 | 357 | 41 | 2.8 | 1.3 | 2.13 | 10 | |
| Olde Marco | 2019 | 7.91 | 26.42 | 5.5 | 82 | 50,412 | 33.0 | 11 | 709 | 720 | 51 | 2.9 | 3.6 | 1.29 | 255 |
| | 2020 | 7.93 | 24.99 | 5.4 | 80 | 52,161 | 34.3 | 13 | 546 | 558 | 37 | 2.9 | 3.7 | 1.43 | 11 |

Annual Geometric Mean Values for Historical Marco Island Monitoring Sites from 2007 -2020

| Sample Site | Year | pH (s.u.) | Temp. (°C) | Diss. O ₂ (mg/L) | Diss. O ₂ (% satn.) | Cond. (µmho/cm) | Salinity (ppt) | NOx (µg/L) | TKN (µg/L) | Total N (µg/L) | Total P (µg/L) | Cnyl-a (mg/m ³) | Turbidity (NTU) | Secchi Depth (m) | Entero (cfu/100 mL) | |
|-------------|----------------------|-----------|------------|-----------------------------|--------------------------------|-----------------|----------------|------------|------------|----------------|----------------|-----------------------------|-----------------|------------------|---------------------|-----|
| Perrine | 2007 | - | - | - | - | - | - | - | 465 | - | - | - | - | - | 1 | |
| | 2008 | - | - | - | - | - | - | - | 453 | - | - | - | - | - | 2 | |
| | 2009 | - | - | - | - | - | - | - | 424 | - | - | - | - | - | 3 | |
| | 2010 | - | - | - | - | - | - | - | 209 | - | - | - | - | - | 2 | |
| | 2011 | - | - | - | - | - | - | - | 495 | - | - | - | - | - | 11 | |
| | 2012 | - | - | - | - | - | - | - | 409 | - | - | - | - | - | 8 | |
| | 2013 | - | - | - | - | - | - | - | 393 | - | - | - | - | - | 24 | |
| | 2014 | - | - | - | - | - | - | - | 272 | - | - | - | - | - | 20 | |
| | 2015 | 7.89 | 25.89 | 6.0 | 90 | 51,425 | 33.7 | 21 | 161 | 181 | 27 | 3.3 | - | 0.70 | 10 | |
| | 2016 | 7.83 | 23.92 | 6.8 | 97 | 48,418 | 31.5 | 32 | 769 | 801 | - | - | - | - | - | |
| | 2017 | 7.80 | 22.80 | 6.4 | 90 | 52,693 | 34.8 | 23 | 574 | 597 | 29 | 2.6 | - | 0.20 | 20 | |
| | Swallow | 2019 | 7.94 | 27.35 | 5.7 | 85 | 48,714 | 31.7 | 35 | 682 | 717 | 93 | 6.8 | 4.3 | 1.29 | 492 |
| | | 2020 | 7.89 | 25.76 | 4.6 | 67 | 48,672 | 31.7 | 26 | 632 | 657 | 58 | 4.9 | 2.5 | 1.40 | 30 |
| | W Winterberry Bridge | 2015 | 7.92 | 26.45 | 6.5 | 99 | 52,272 | 34.3 | 19 | 448 | 467 | - | - | - | 1.71 | - |
| 2016 | | 7.89 | 24.73 | 6.3 | 91 | 49,491 | 32.3 | 15 | 396 | 410 | - | - | - | 2.08 | - | |
| 2017 | | 7.94 | 27.37 | 6.0 | 92 | 51,668 | 33.9 | 6 | 485 | 491 | 51 | 4.2 | - | 1.55 | 16 | |
| 2018 | | 7.91 | 26.58 | 6.2 | 94 | 52,515 | 34.5 | 11 | 654 | 665 | 28 | 4.6 | - | 1.76 | 25 | |
| 2019 | | 7.91 | 26.58 | 6.2 | 94 | 52,515 | 34.5 | 11 | 654 | 665 | 28 | 4.6 | - | 1.76 | 25 | |
| 2020 | | 7.98 | 25.84 | 5.7 | 85 | 50,794 | 33.3 | 20 | 593 | 613 | 46 | 3.5 | 2.5 | 1.54 | 12 | |
| 2007 | | - | - | - | - | - | - | - | 539 | - | - | - | - | - | 2 | |
| 2008 | | - | - | - | - | - | - | - | 324 | - | - | - | - | - | 4 | |
| 2009 | - | - | - | - | - | - | - | 332 | - | - | - | - | - | 3 | | |
| 2010 | - | - | - | - | - | - | - | 269 | - | - | - | - | - | 2 | | |
| 2011 | - | - | - | - | - | - | - | 470 | - | - | - | - | - | 6 | | |
| 2012 | - | - | - | - | - | - | - | 455 | - | - | - | - | - | 10 | | |
| 2013 | - | - | - | - | - | - | - | 417 | - | - | - | - | - | 34 | | |
| 2014 | - | - | - | - | - | - | - | 211 | - | - | - | - | - | 23 | | |
| 2015 | 7.89 | 26.41 | 6.2 | 94 | 51,650 | 33.9 | 21 | 260 | 281 | 31 | 4.1 | - | 1.49 | 12 | | |
| 2016 | 7.82 | 24.27 | 6.1 | 86 | 47,247 | 30.7 | 23 | 474 | 498 | - | - | - | 1.59 | - | | |
| 2017 | 7.79 | 27.24 | 5.6 | 84 | 50,365 | 32.9 | 4 | 509 | 513 | 27 | 4.3 | - | 1.67 | 16 | | |
| 2018 | 7.77 | 26.53 | 5.6 | 84 | 51,715 | 33.9 | 12 | 664 | 677 | 74 | 5.4 | - | 1.43 | 69 | | |
| 2019 | 7.81 | 27.91 | 5.8 | 88 | 49,782 | 32.5 | 11 | 461 | 472 | 70 | 7.0 | 3.4 | 1.23 | 71 | | |
| 2020 | 7.90 | 26.01 | 5.7 | 83 | 49,501 | 32.4 | 14 | 576 | 590 | 48 | 5.1 | 3.0 | 1.35 | 13 | | |

**A-3: Temporal Plots and Regression Analyses for Marco
Island Historical Monitoring Data**

Barfield Bridge

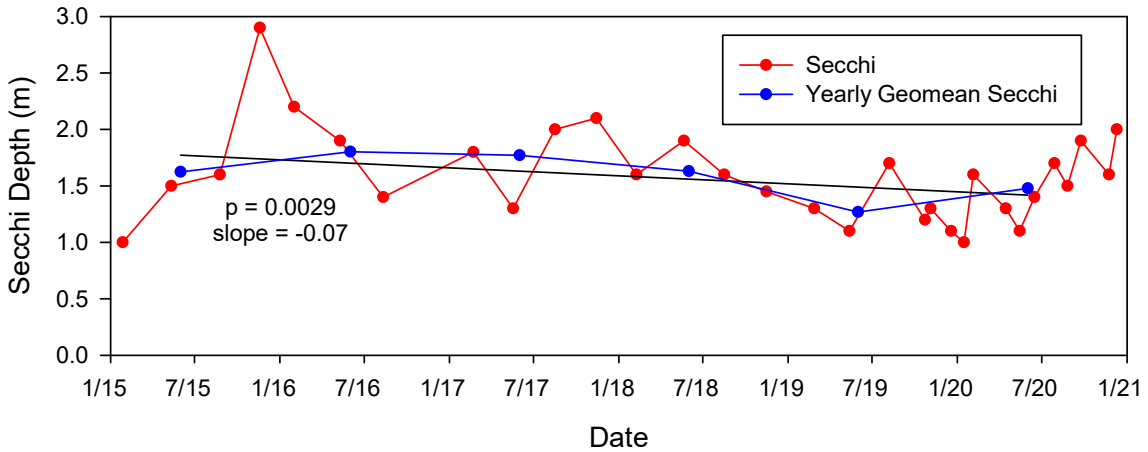
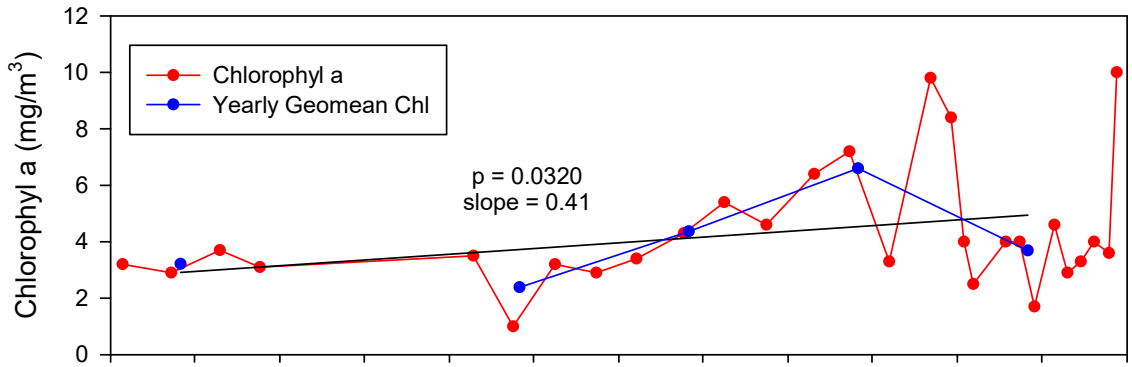
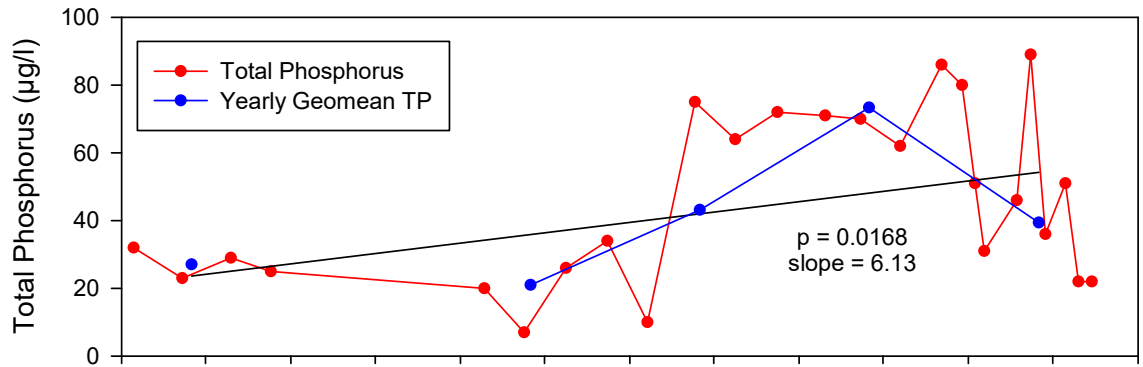
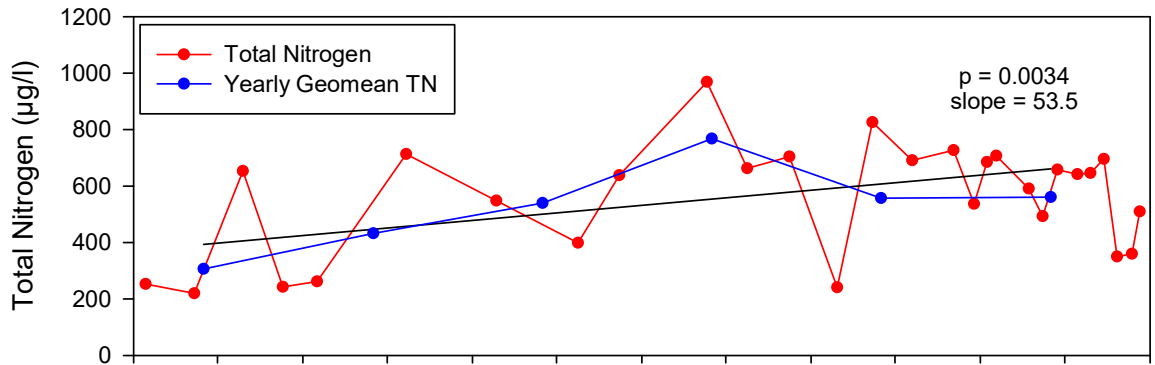

Collier Bridge

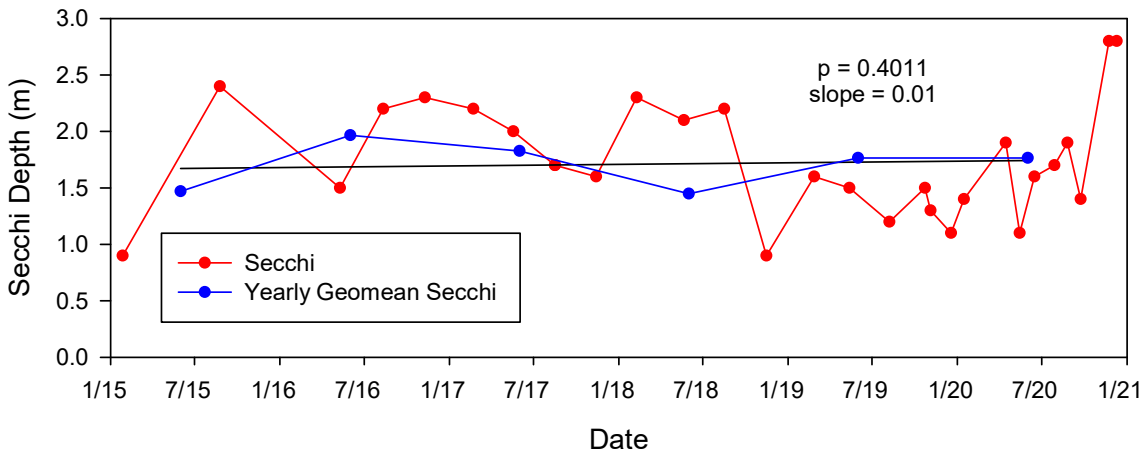
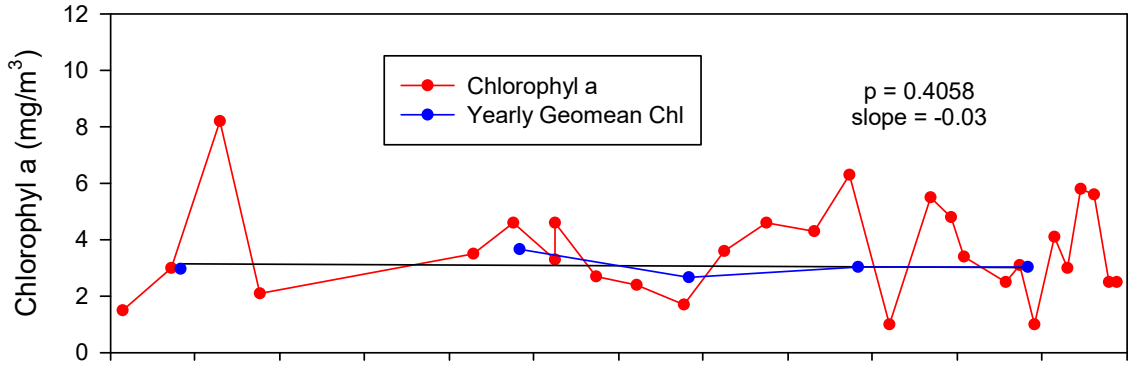
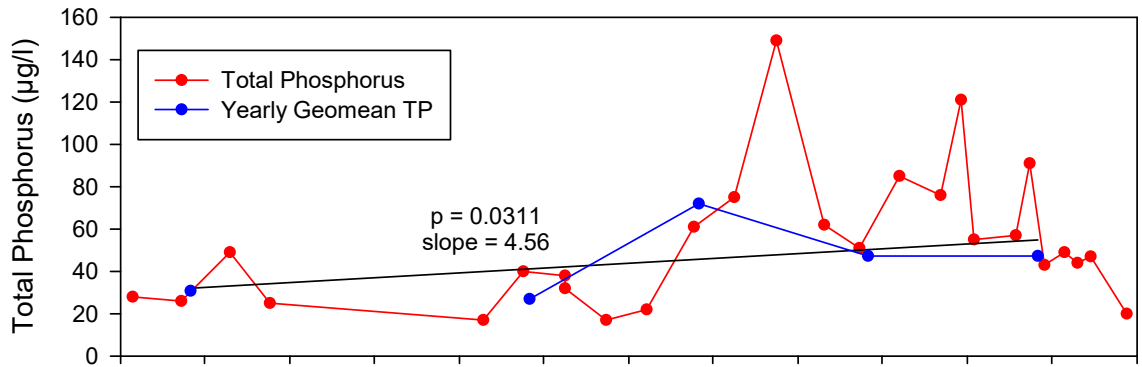
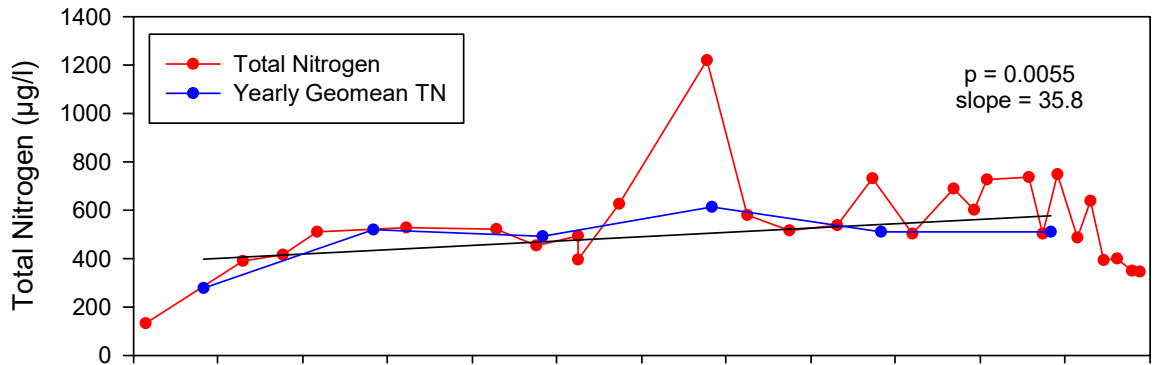

E Winterberry Bridge

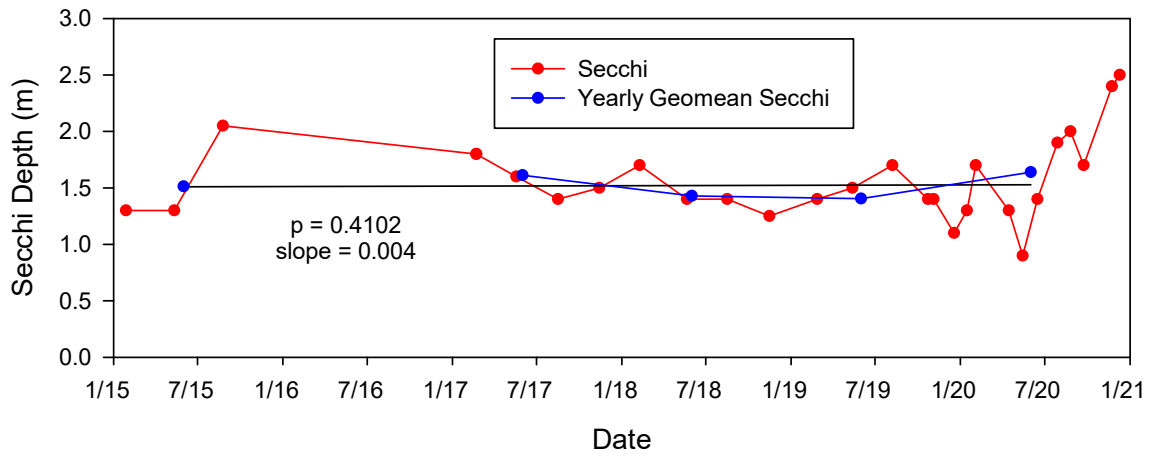
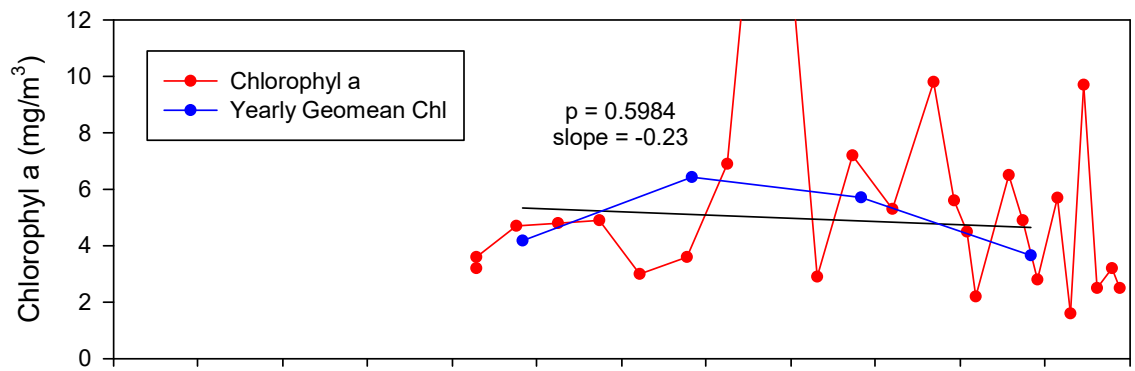
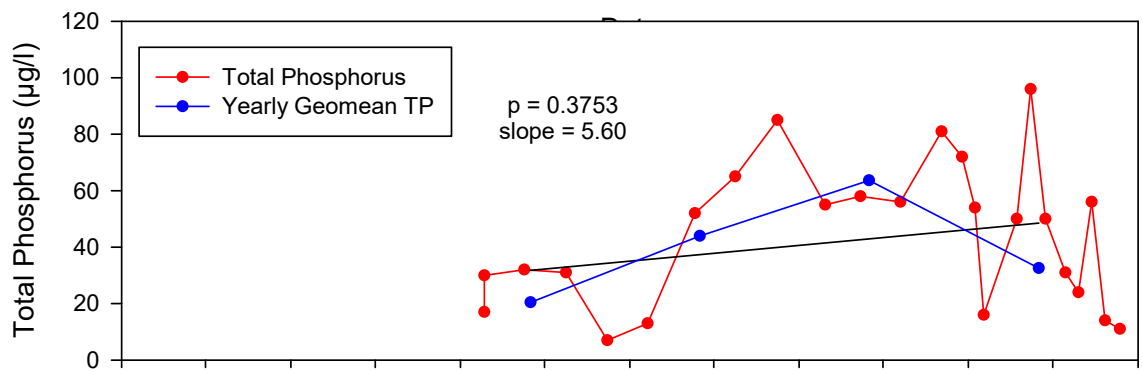
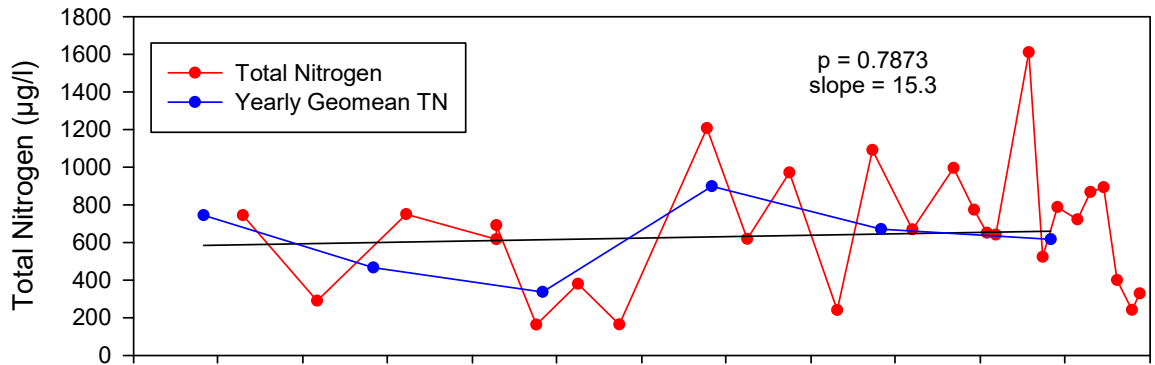

HC Center

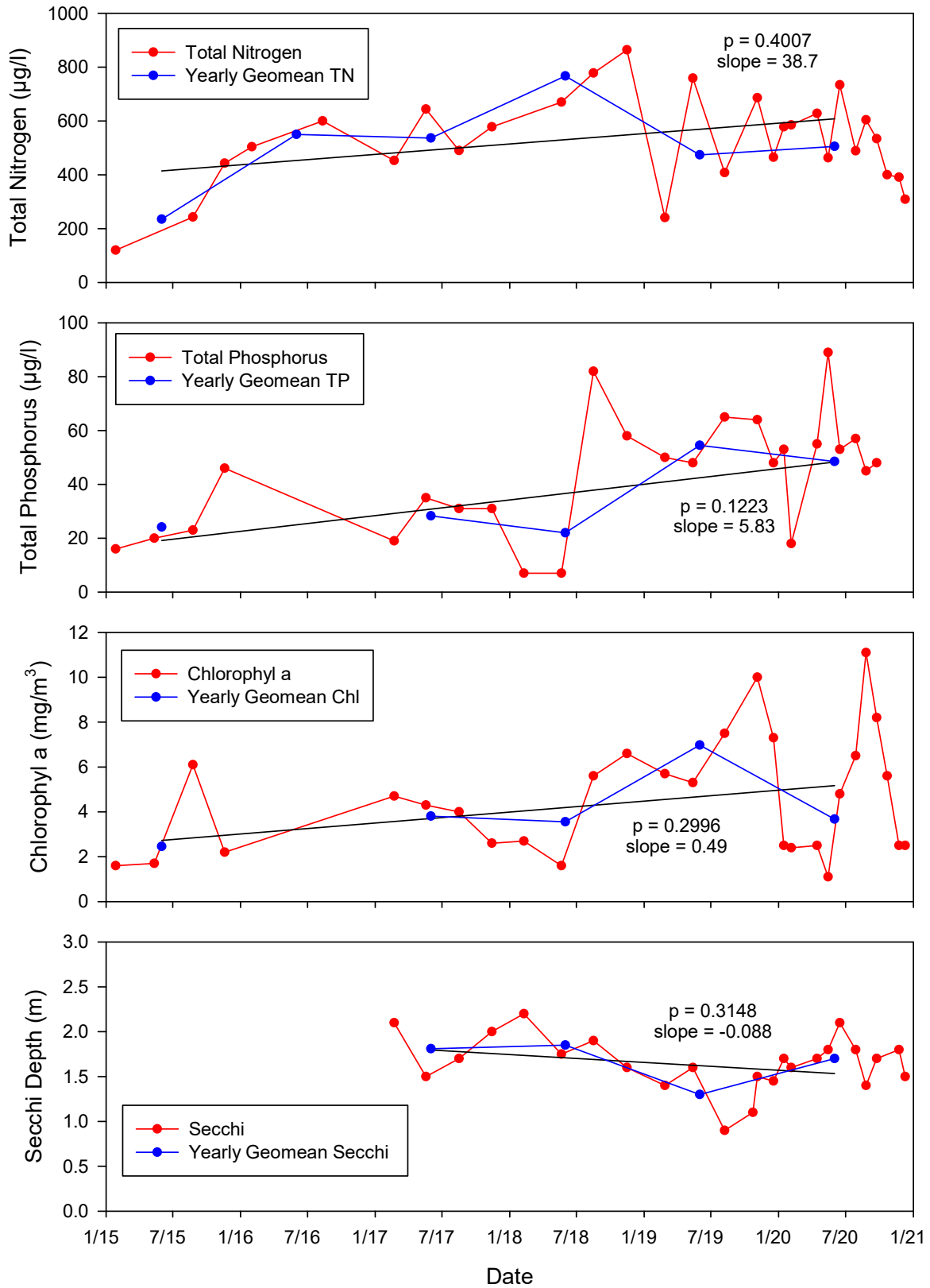

Hollyhock

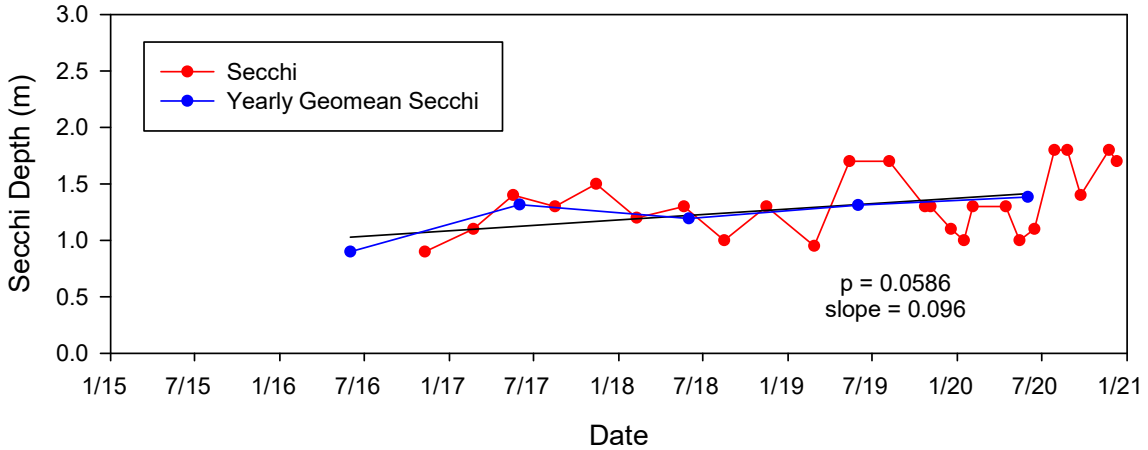
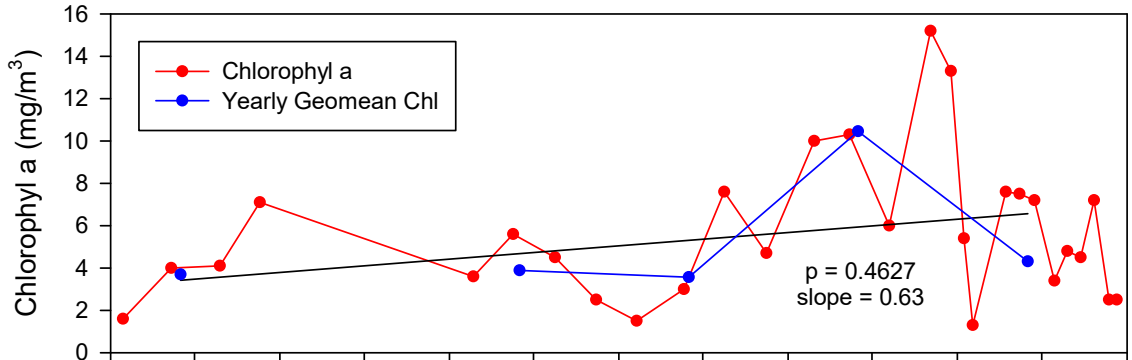
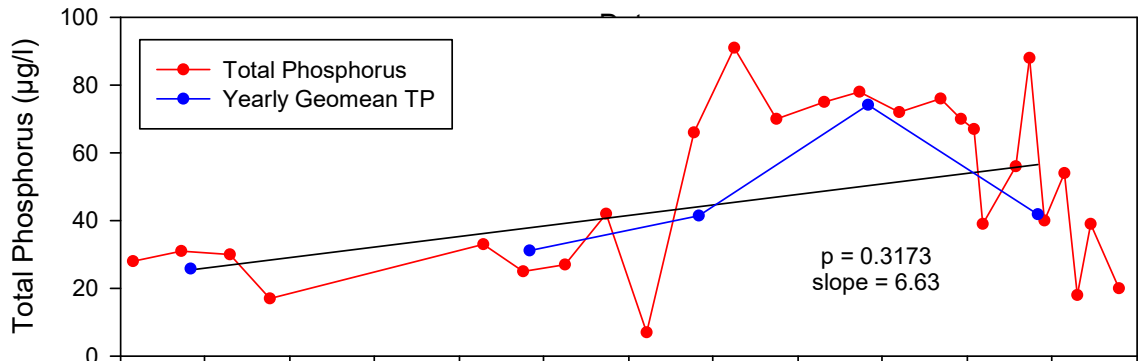
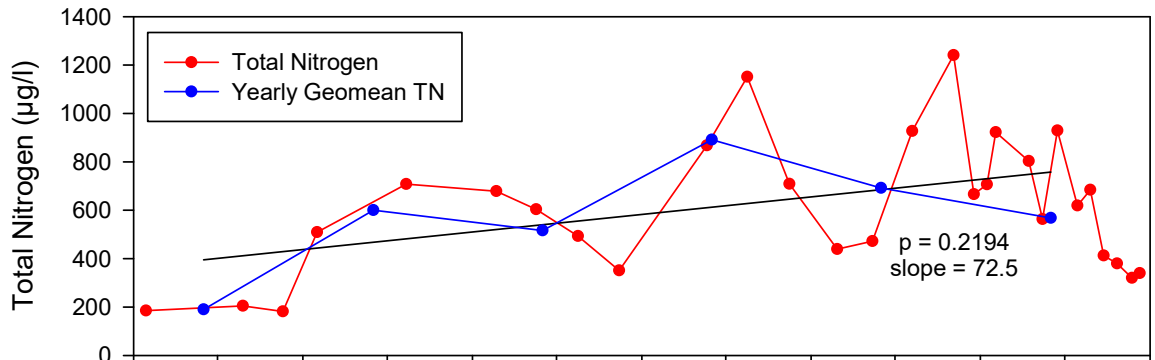

Hummingbird

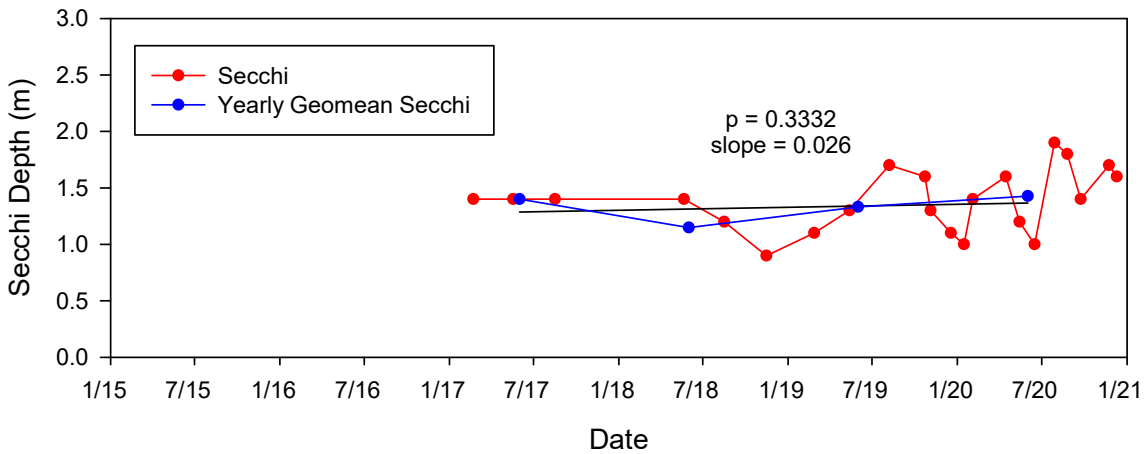
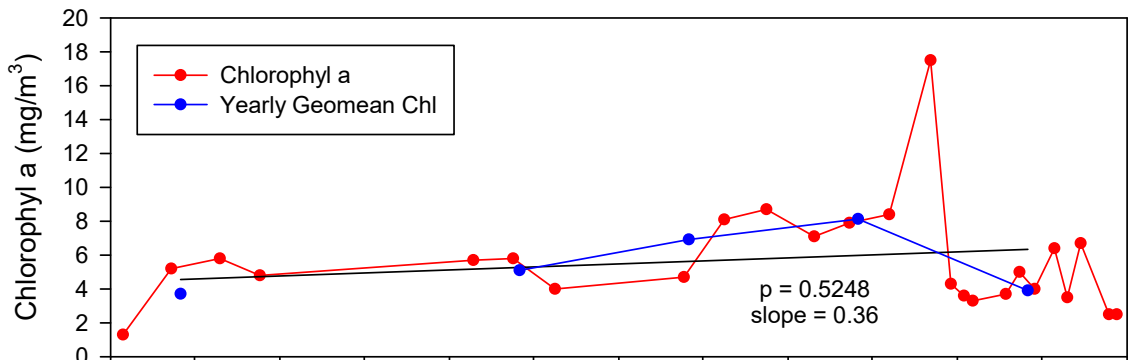
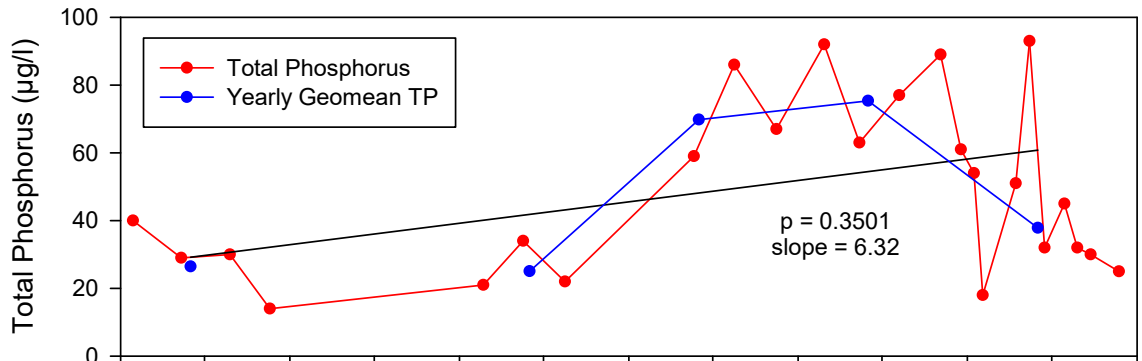
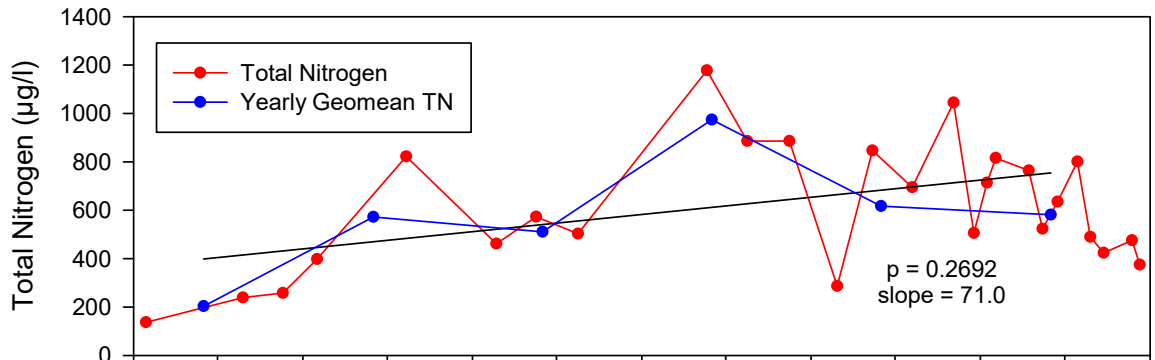

JH Park

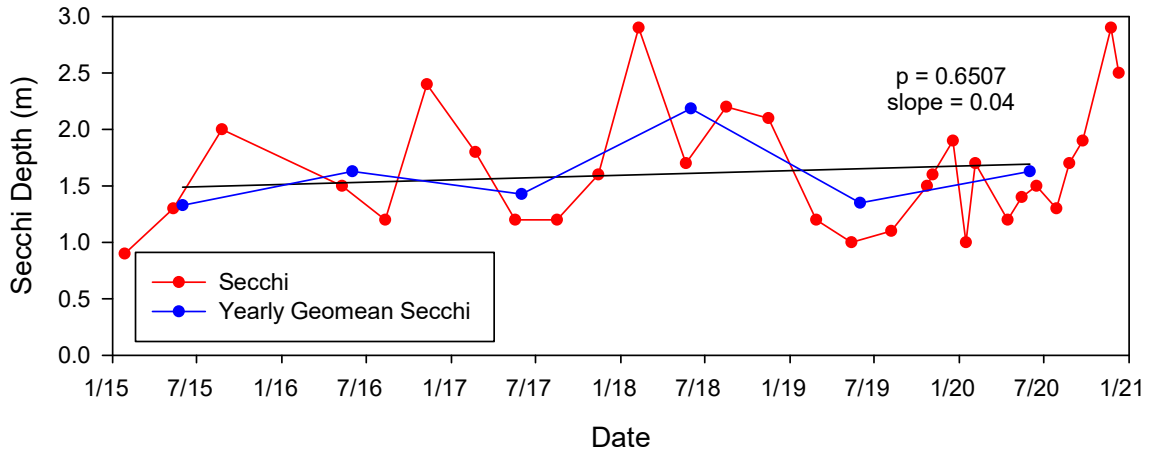
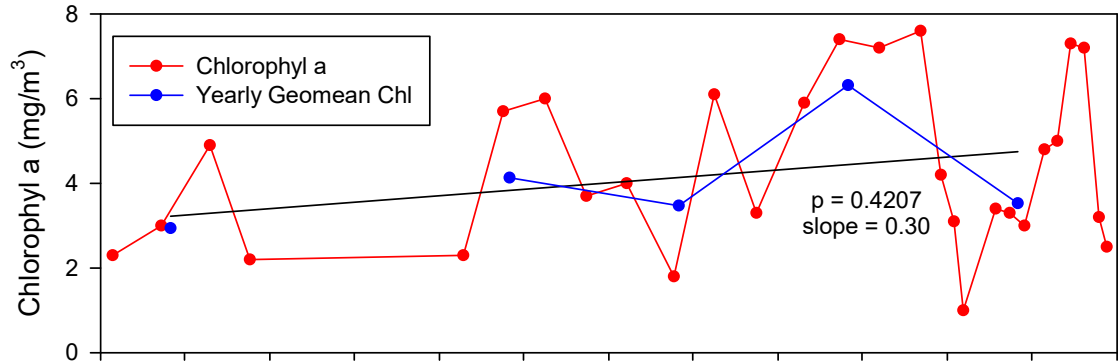
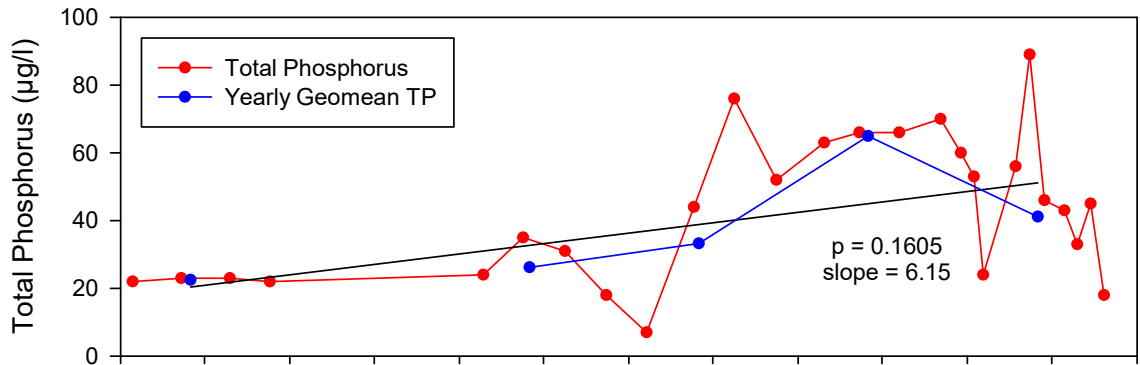
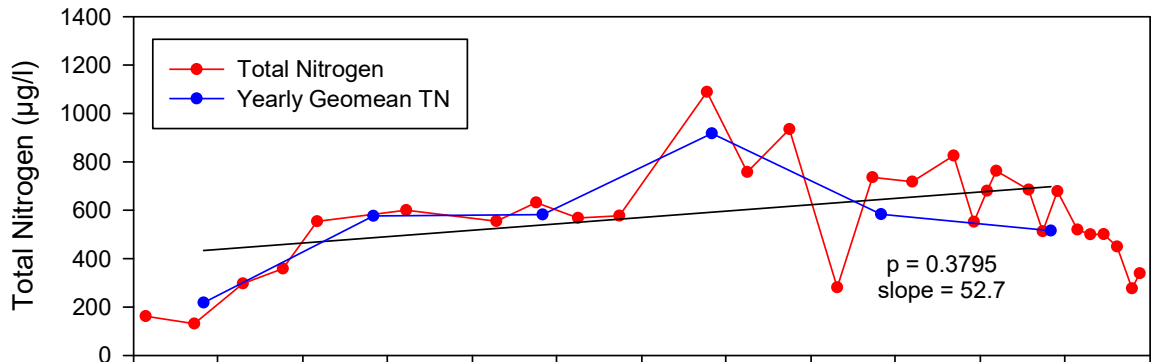

Kendall

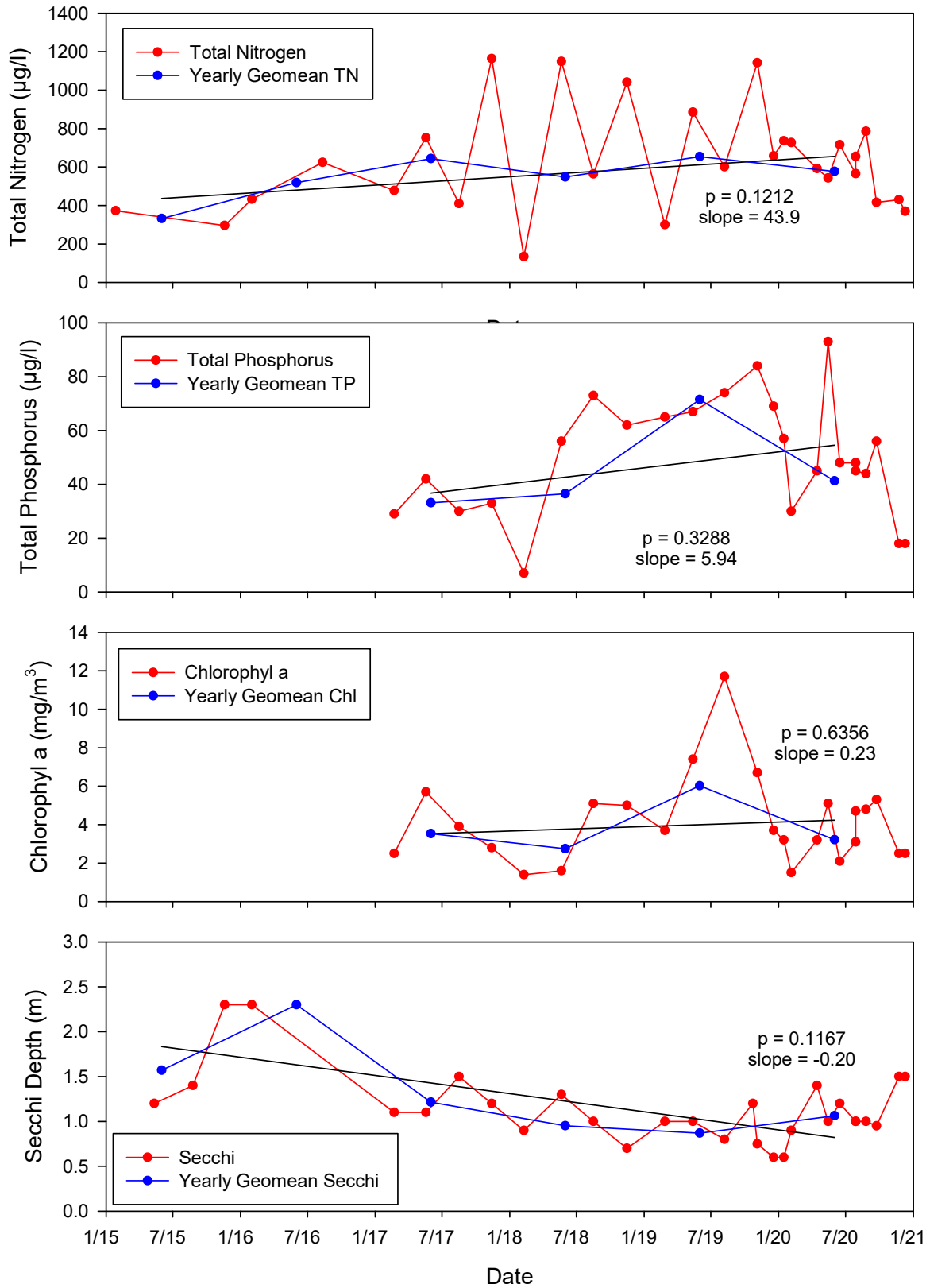

Landmark

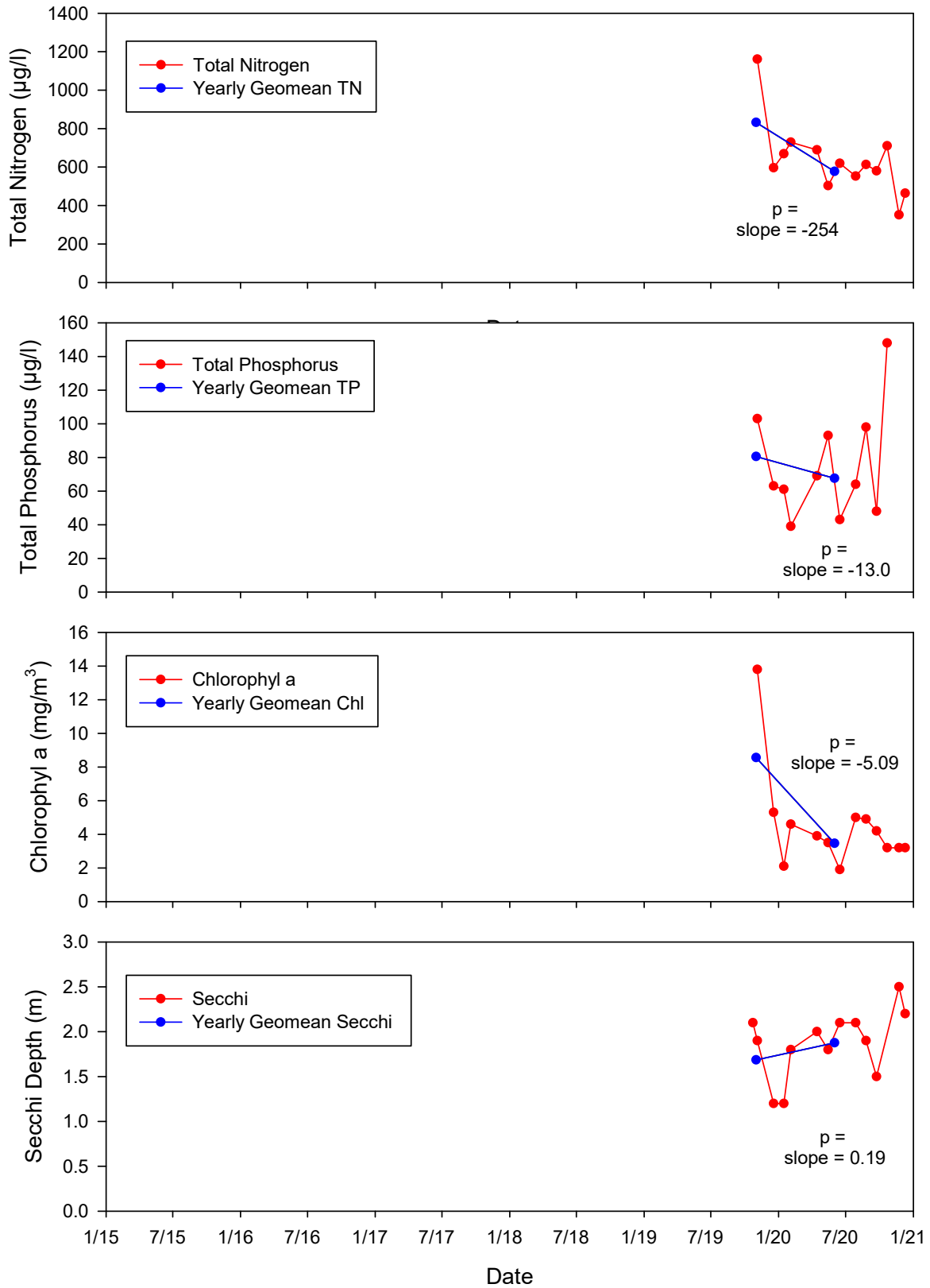

Mcllvaine

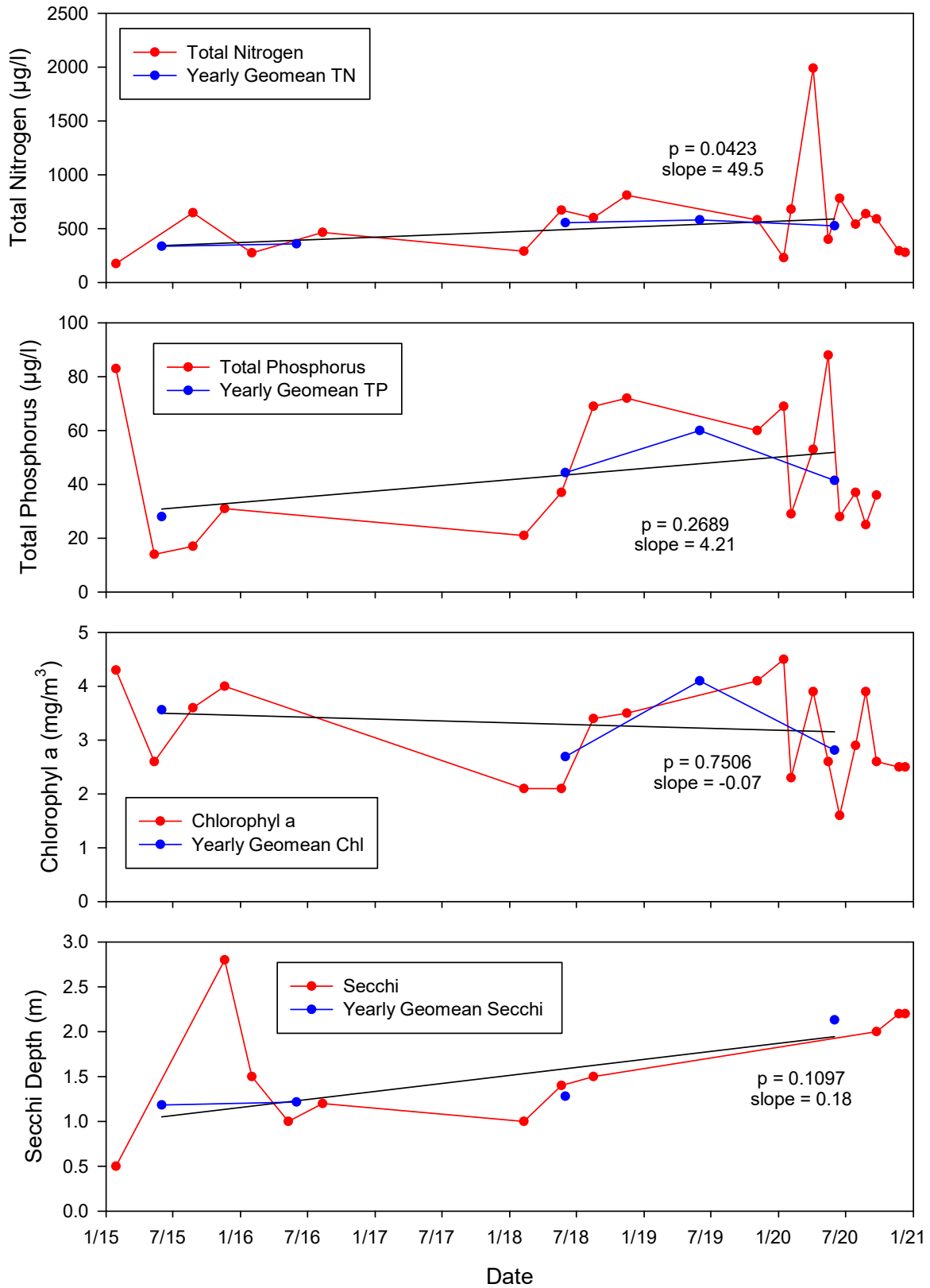

Olde Marco

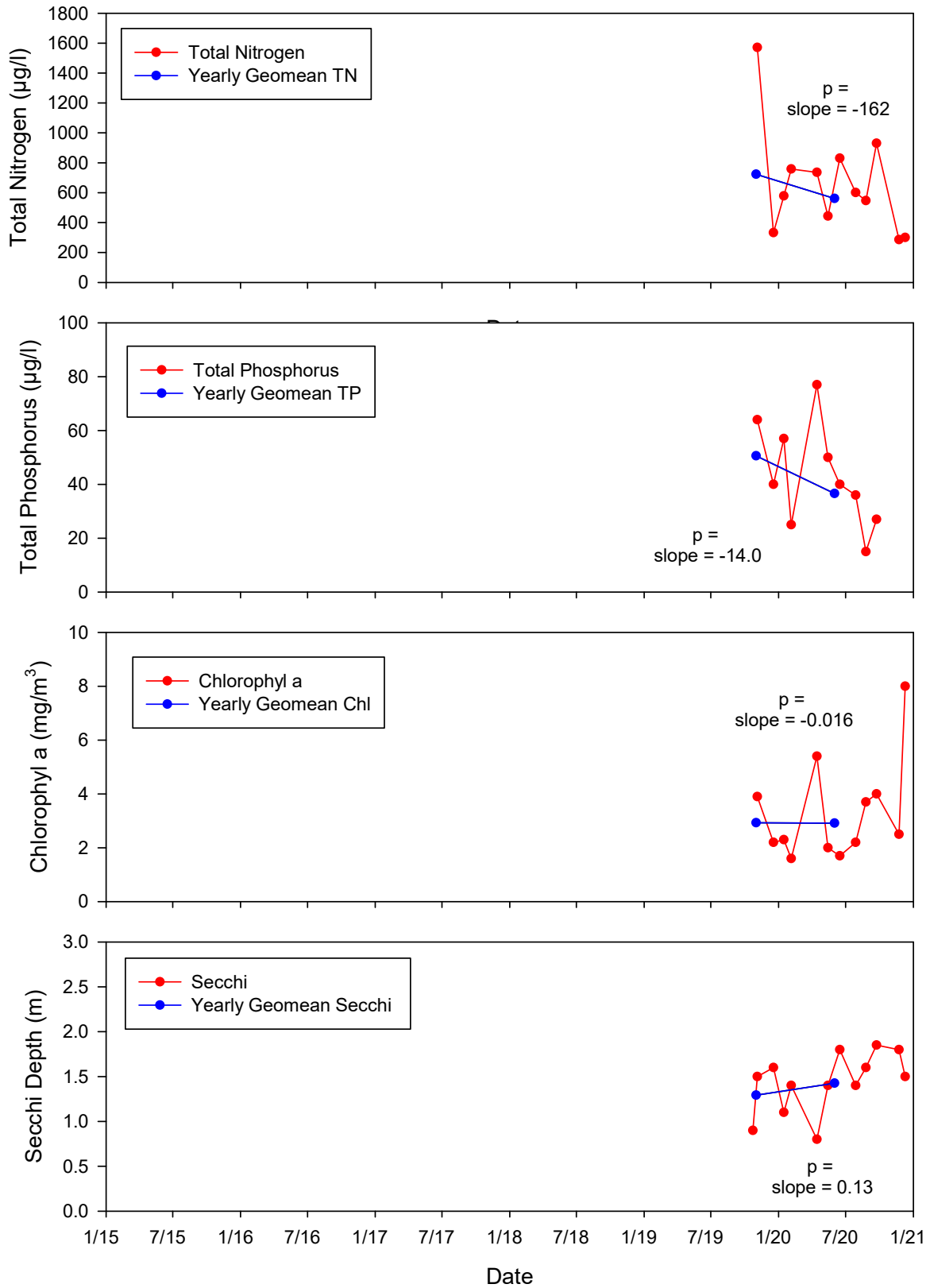

Perrine

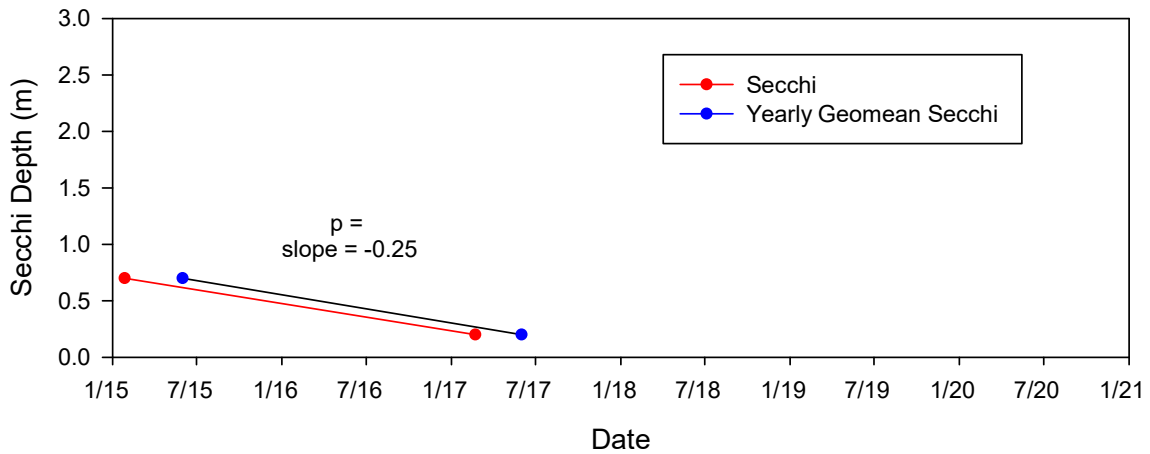
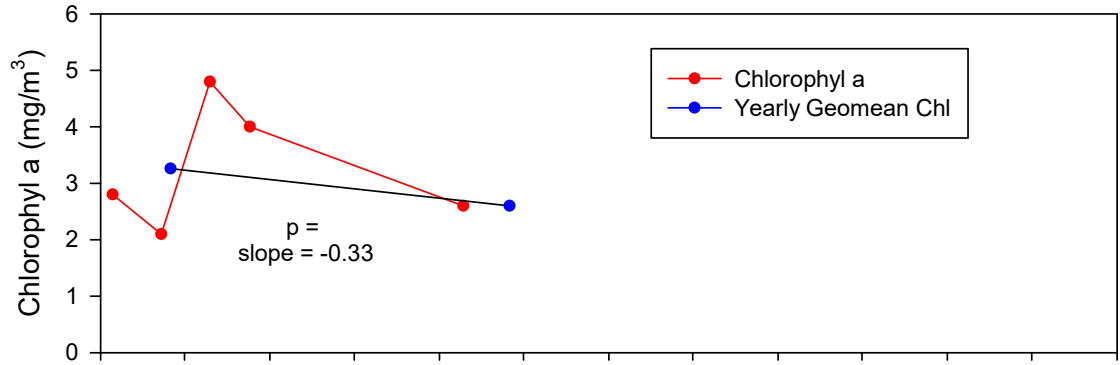
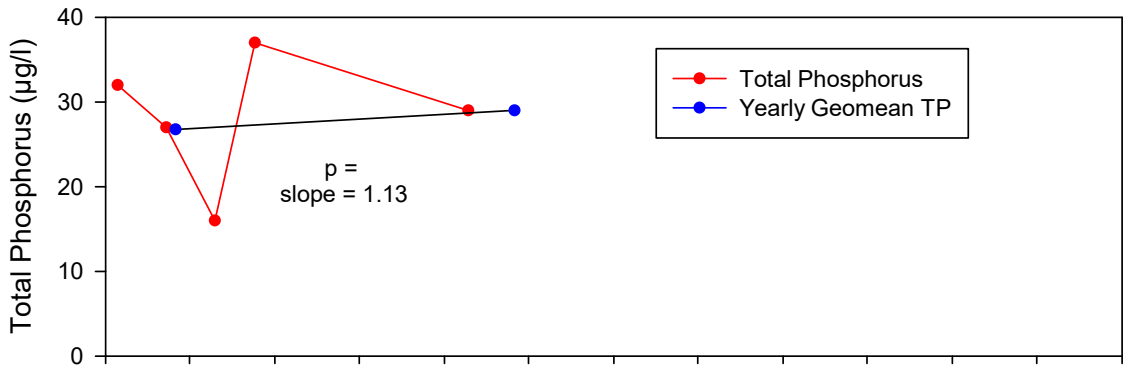
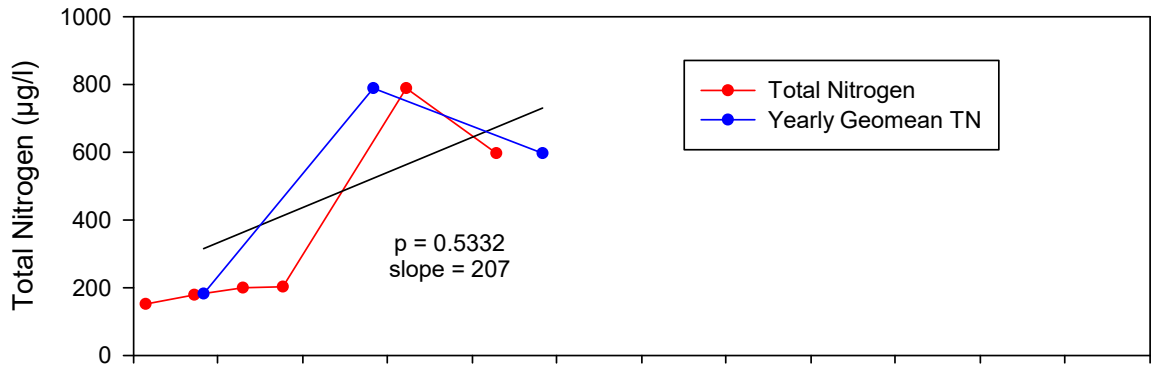

Swallow

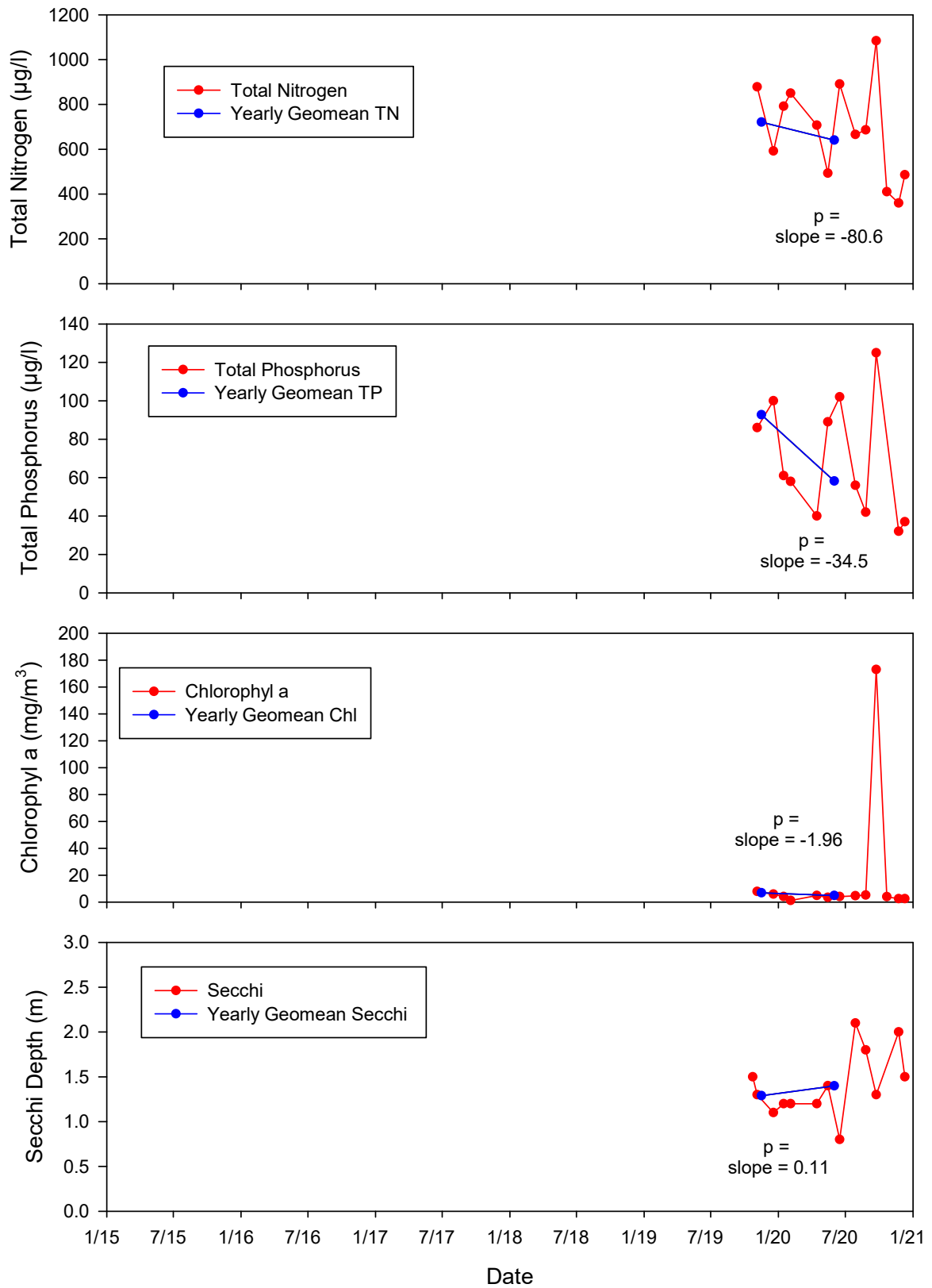

W Winterberry Bridge

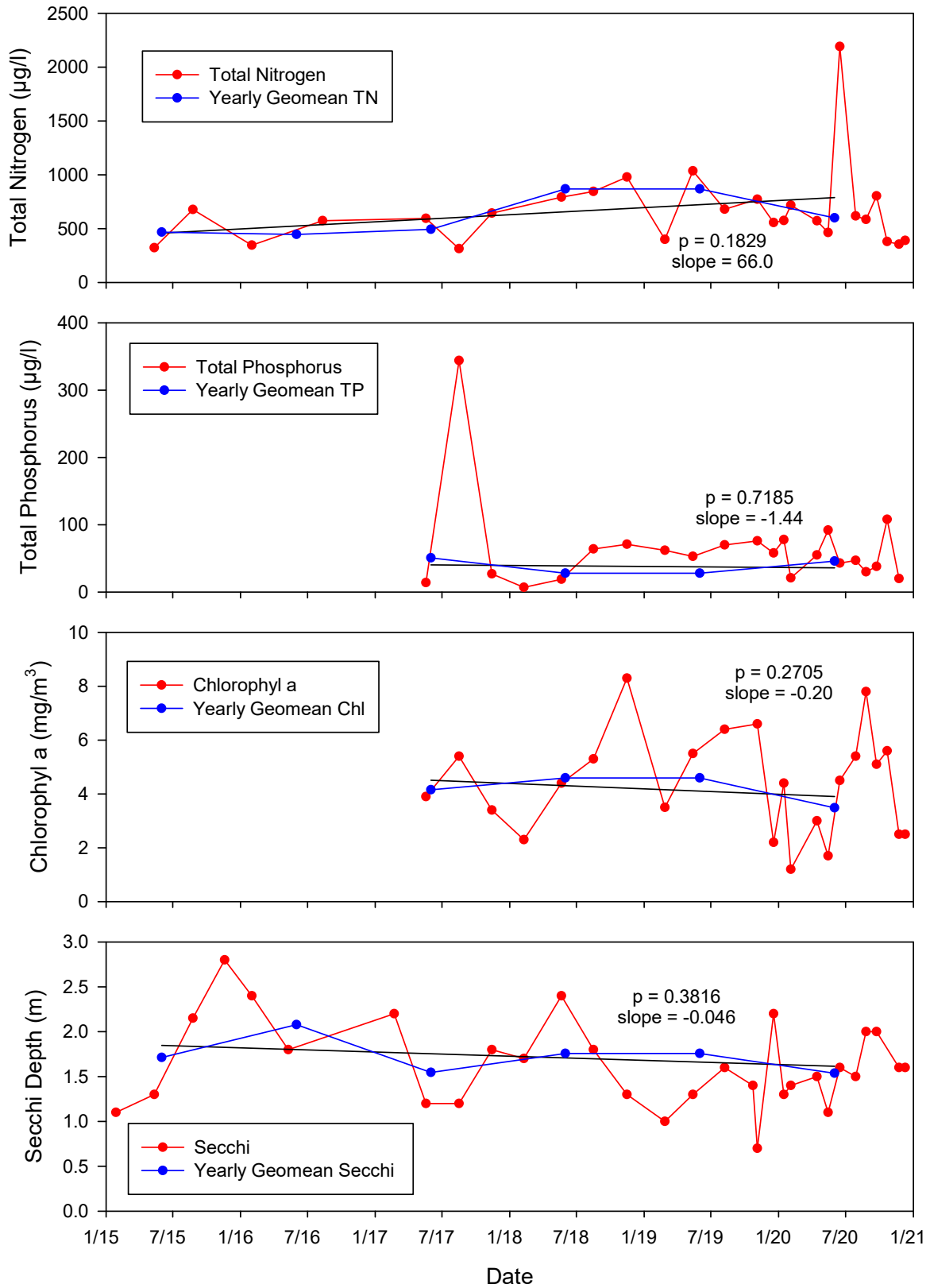

Windmill

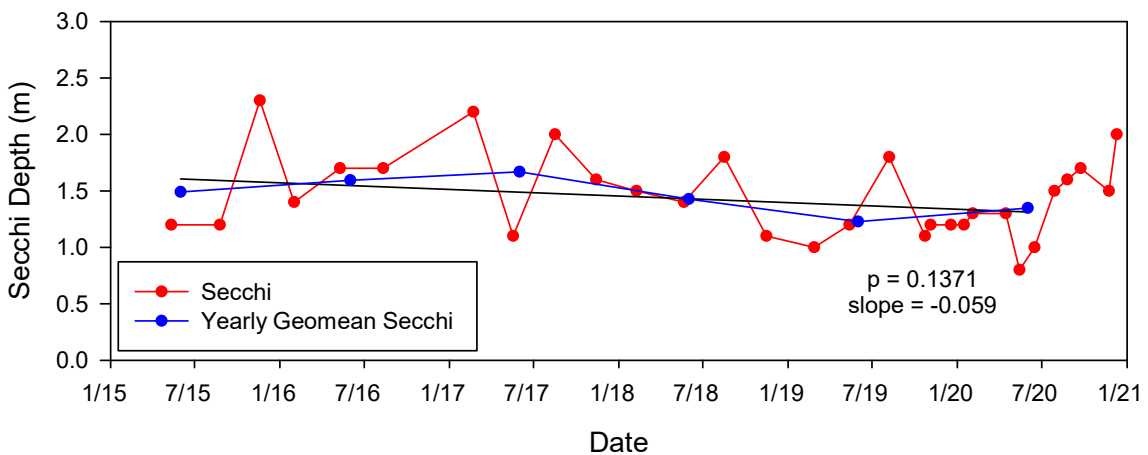
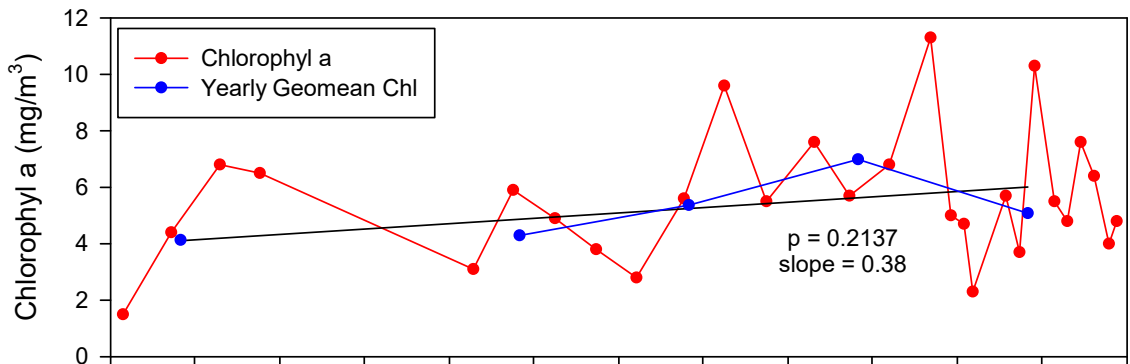
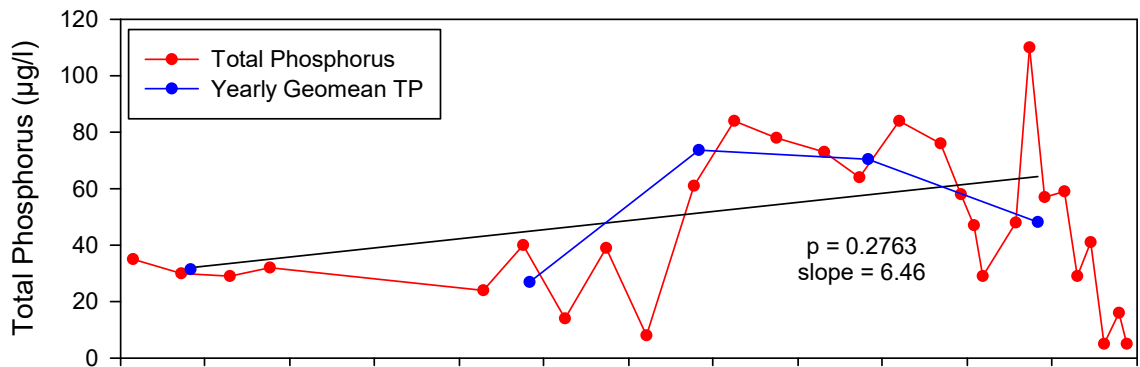
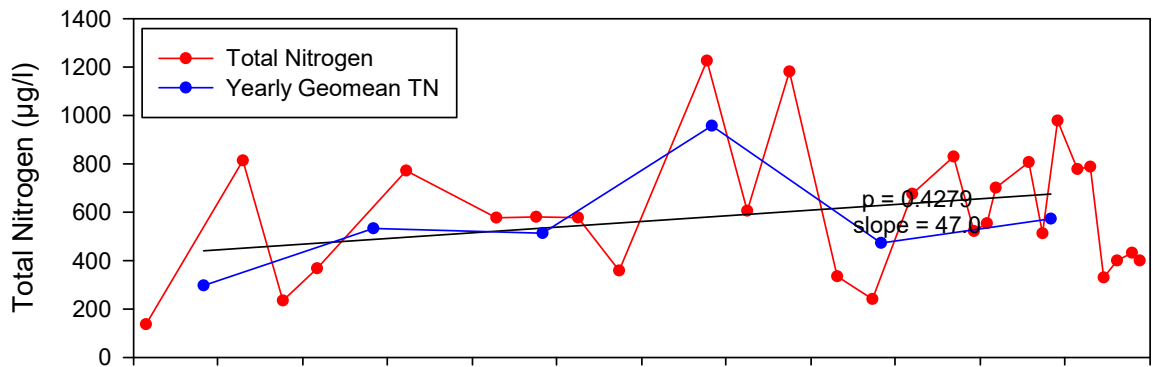

**A-4: Box and Whisker Plots for Historical Marco Island Water Quality Data
by Site**

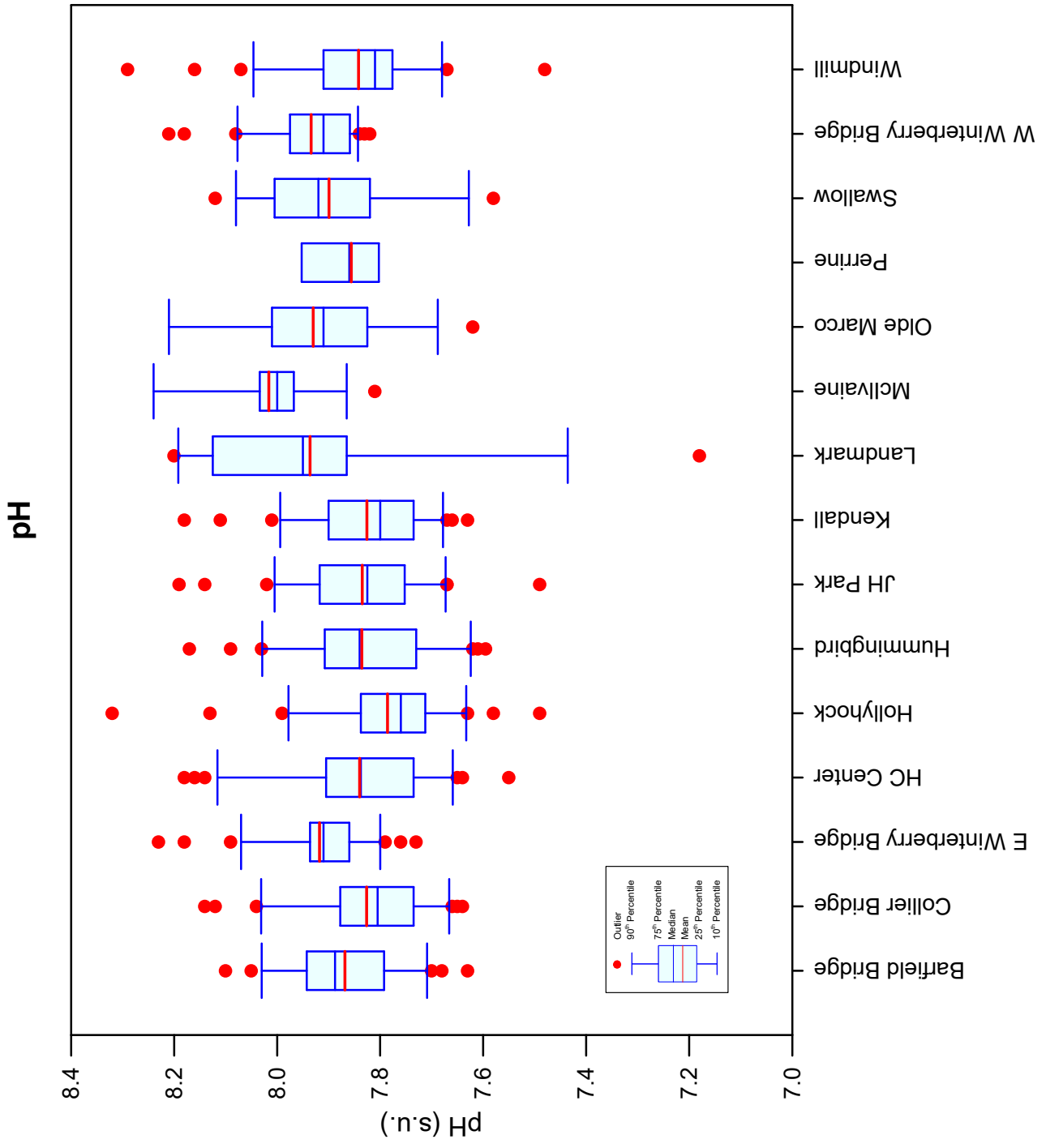

Temperature

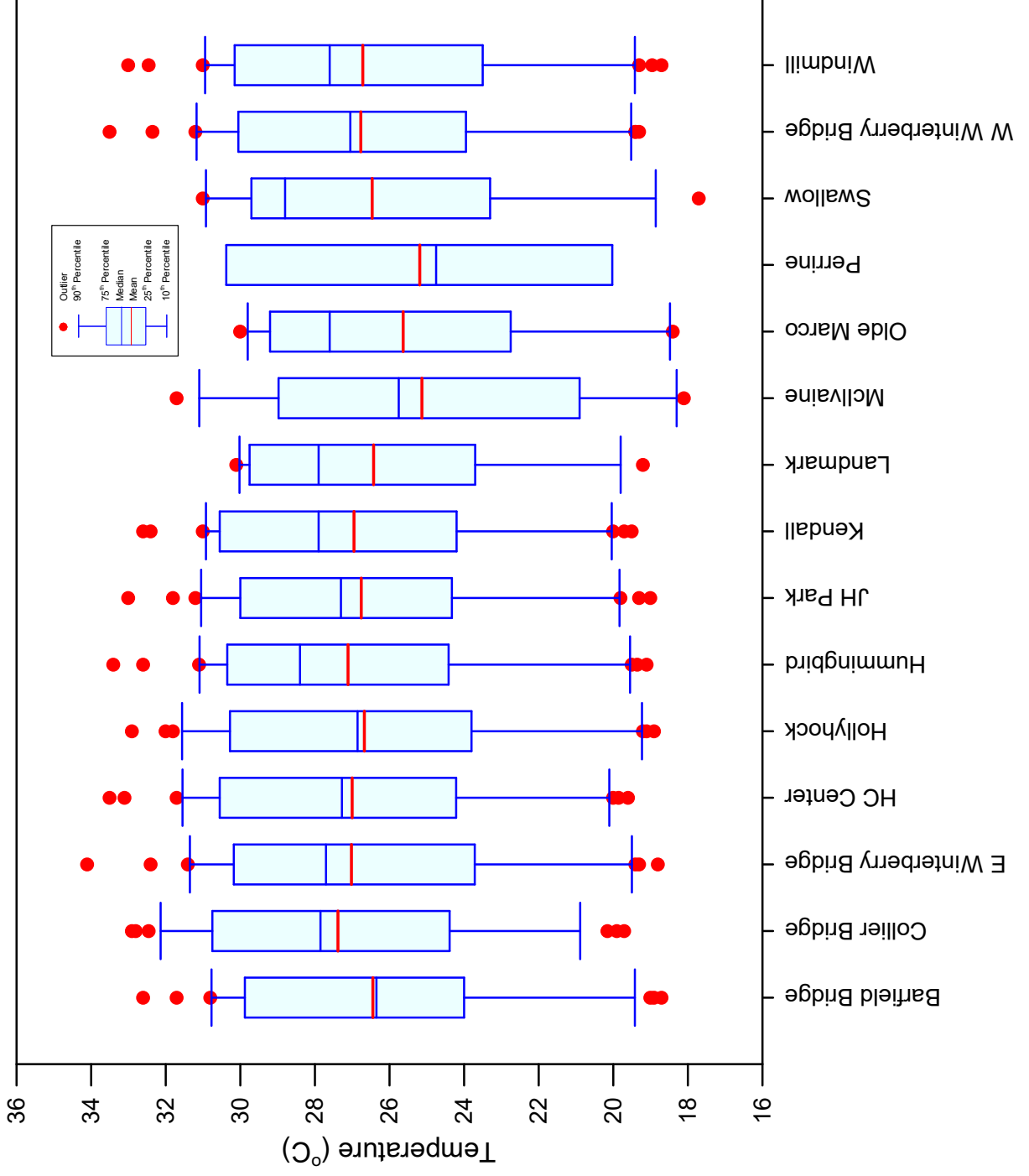

Salinity

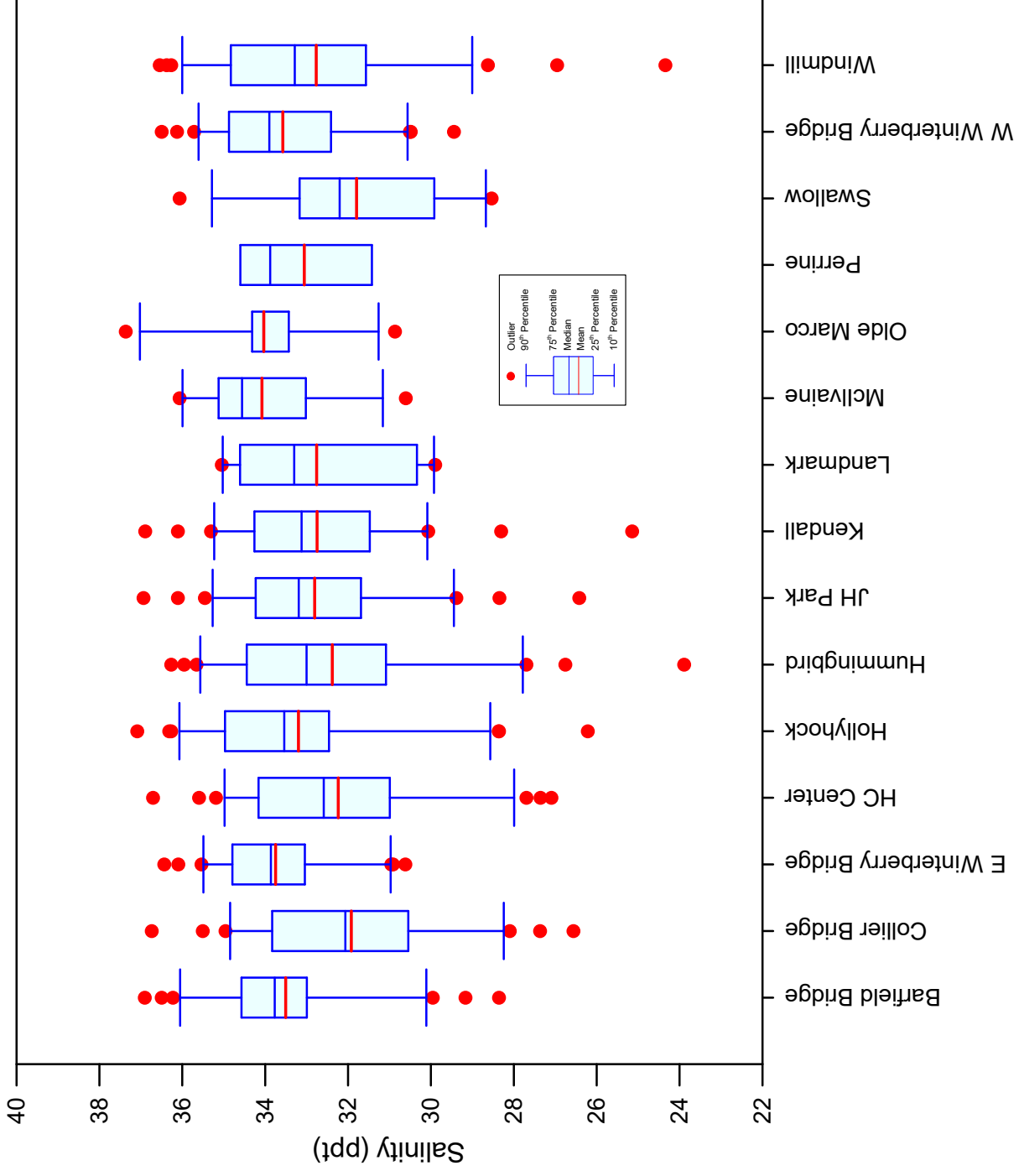

Dissolved Oxygen

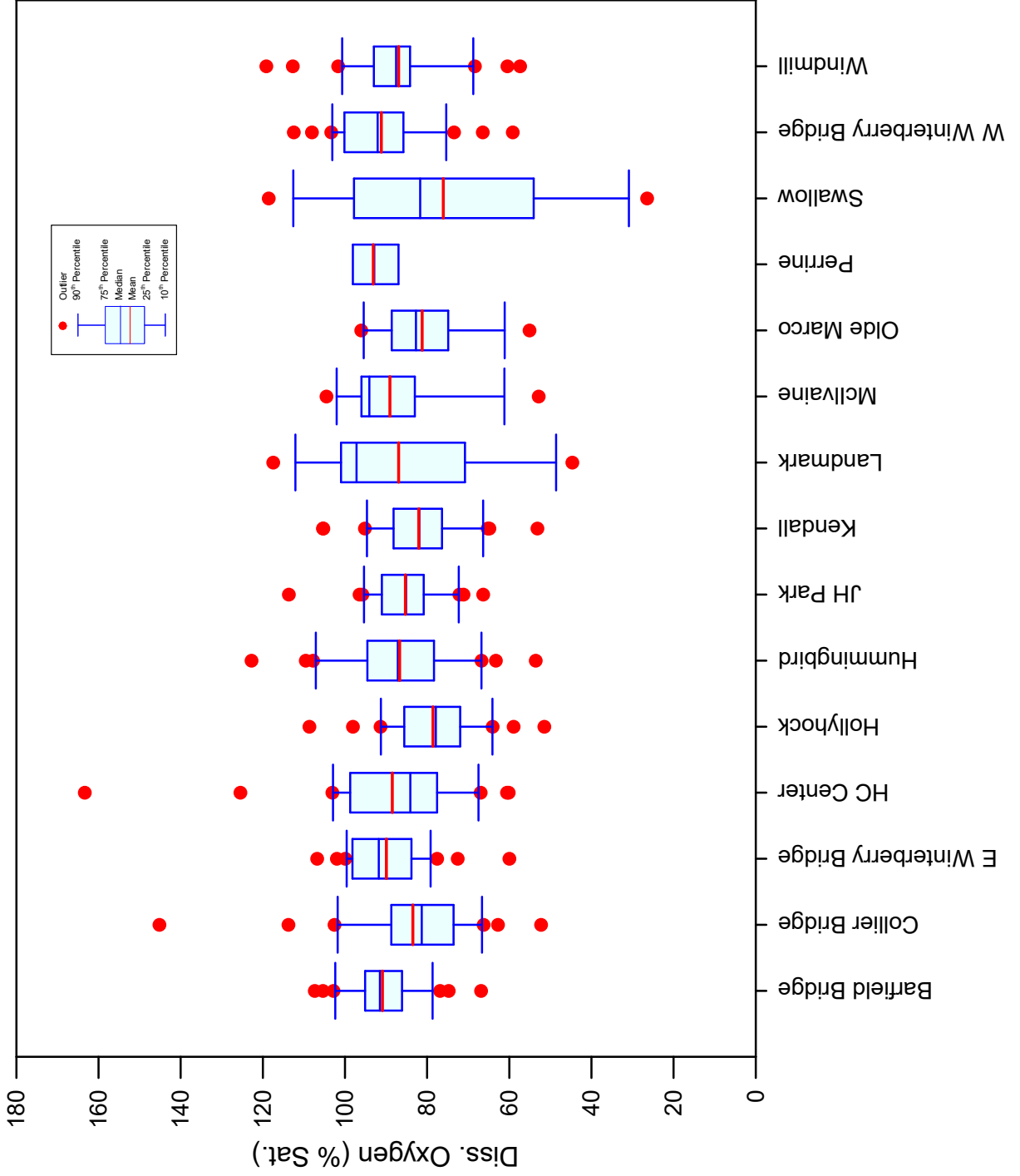

Dissolved Oxygen

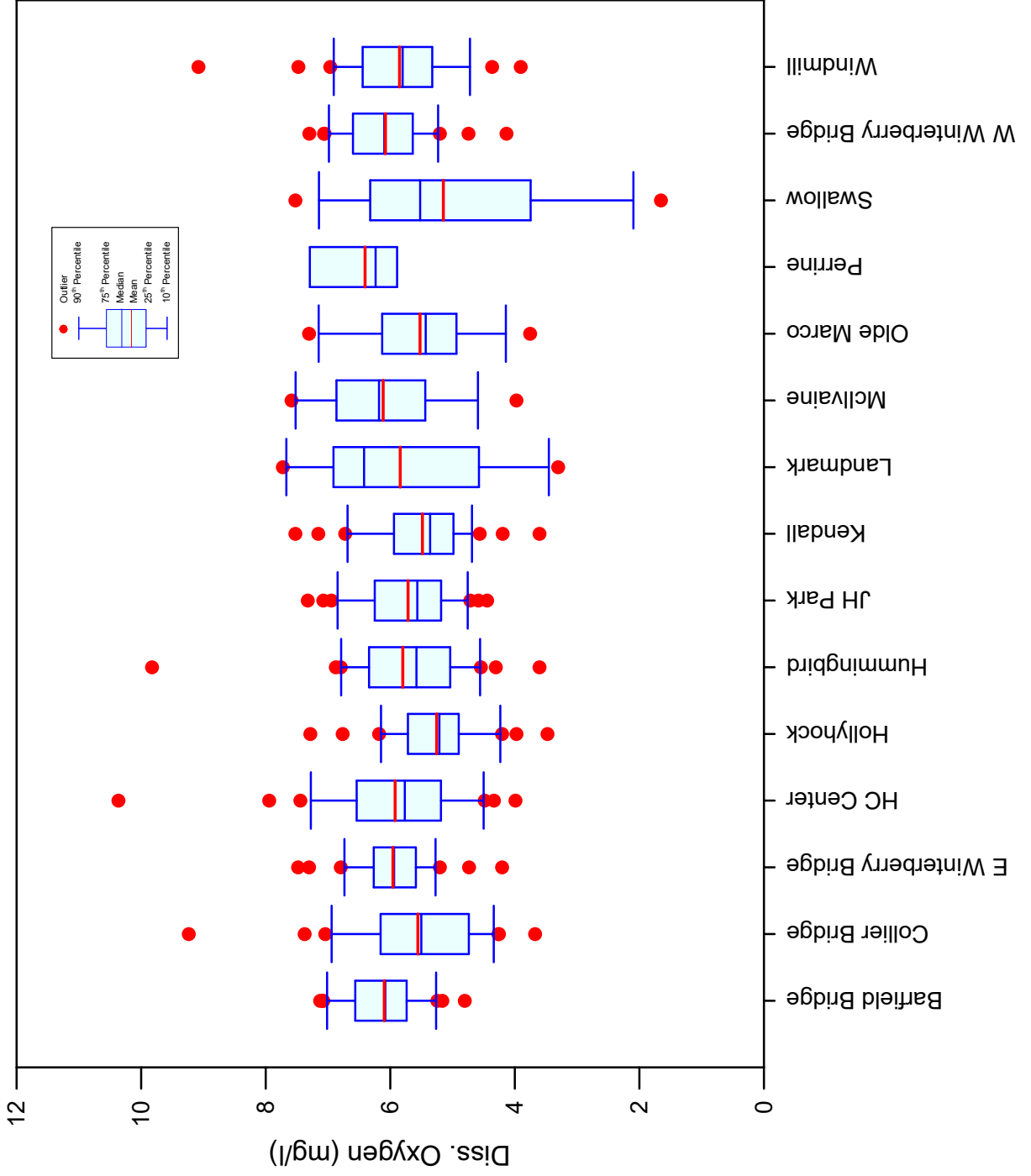

Conductivity

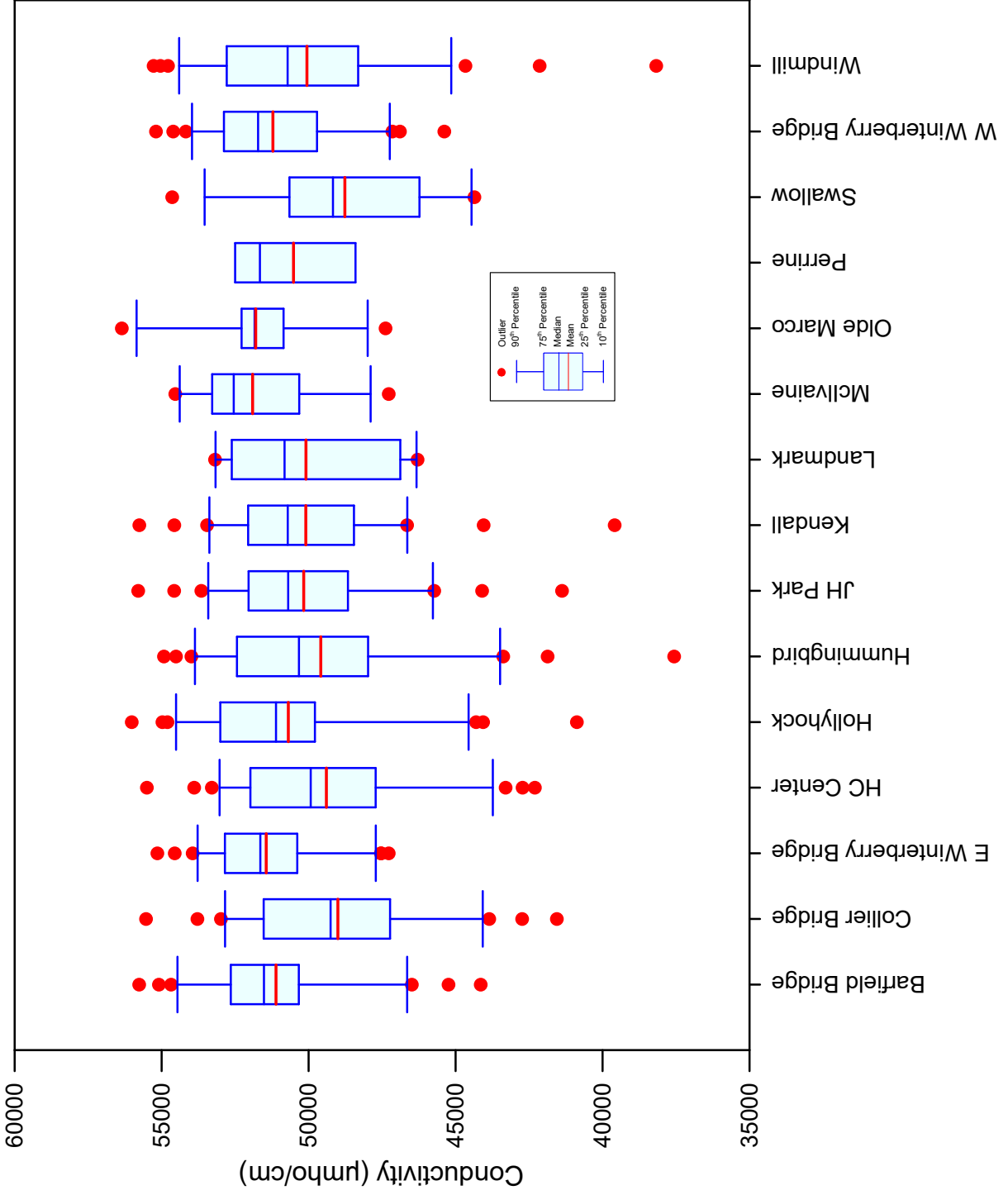

Nitrate - Nitrite

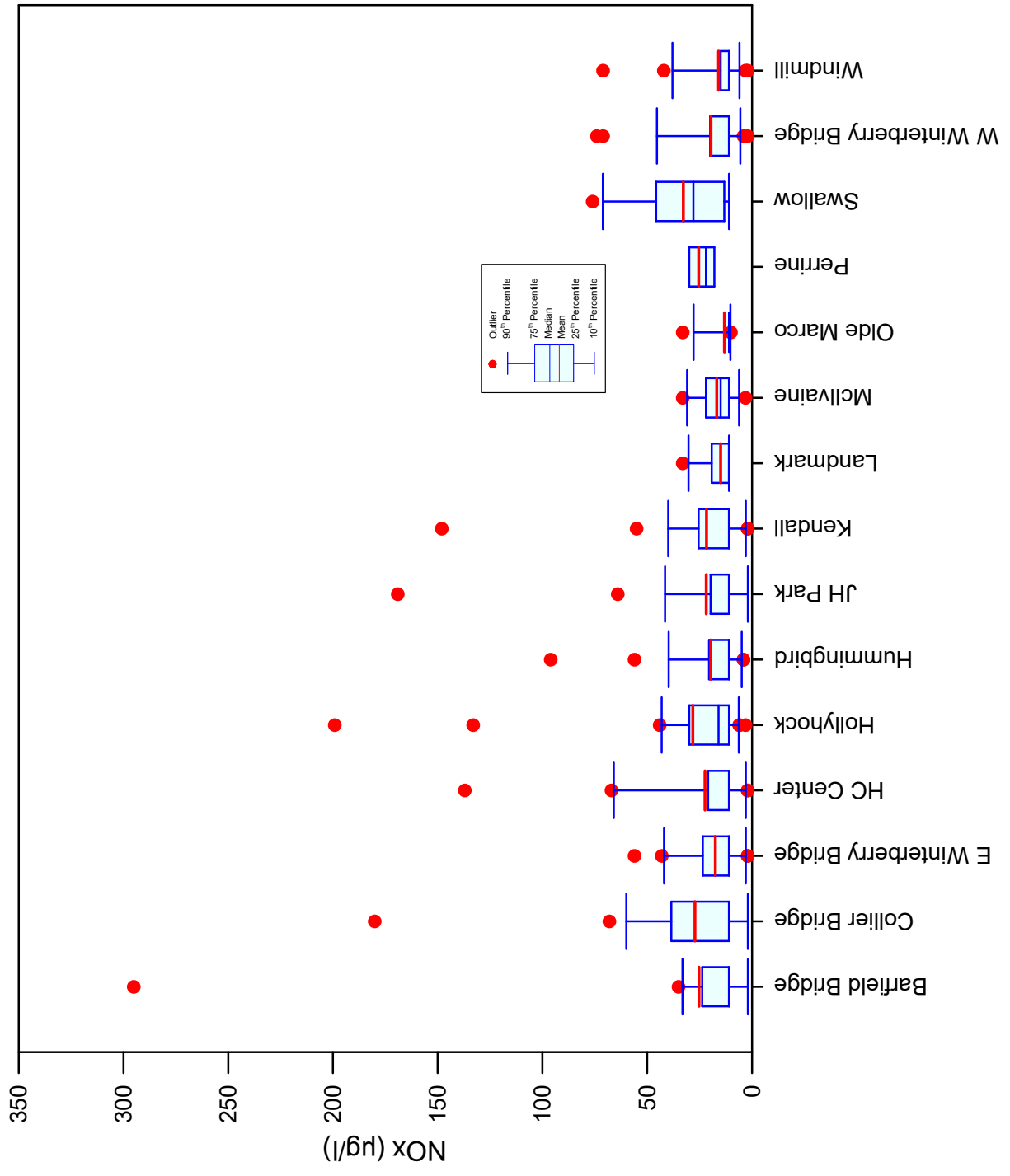

Nitrate - Nitrite

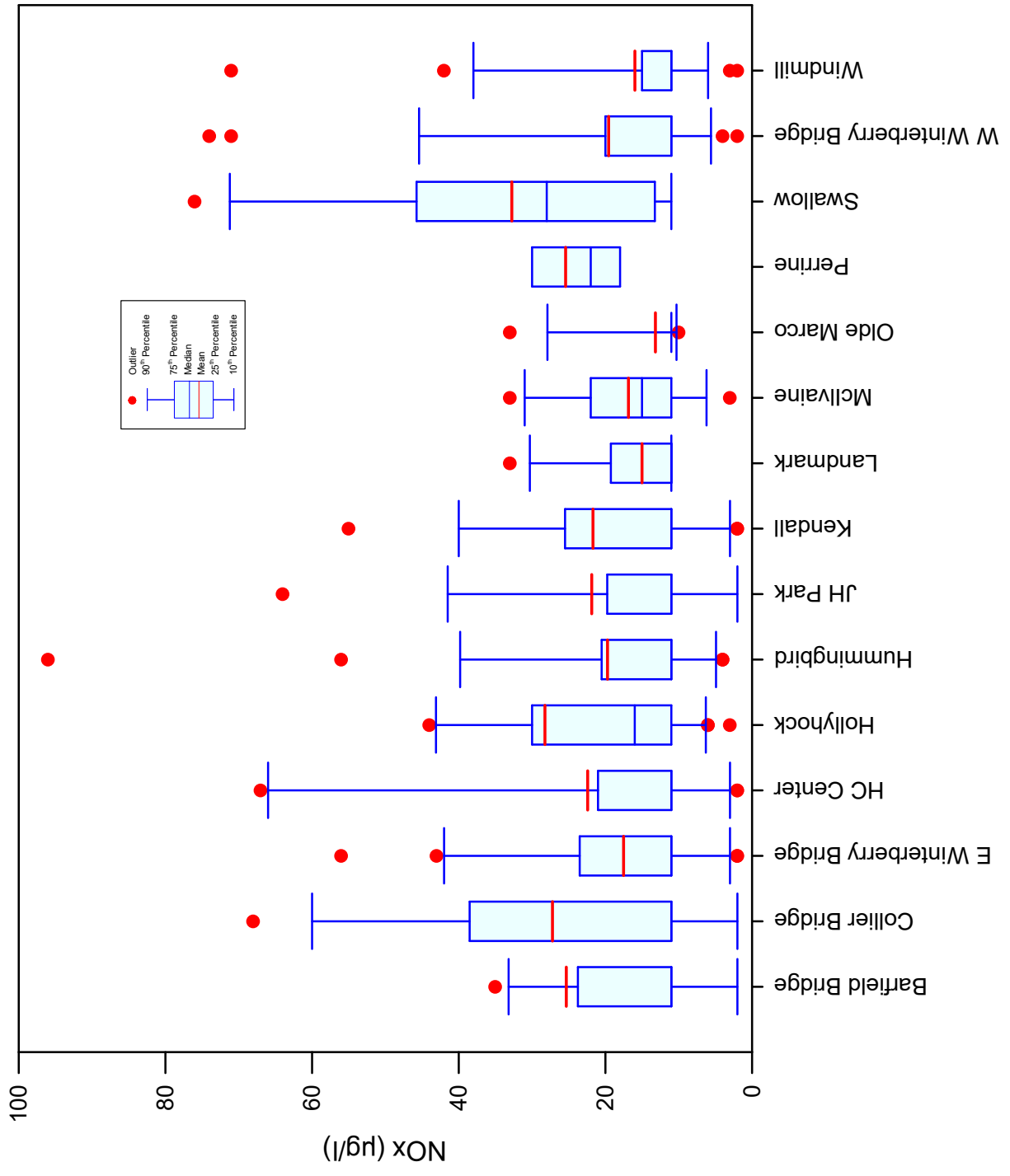

TKN

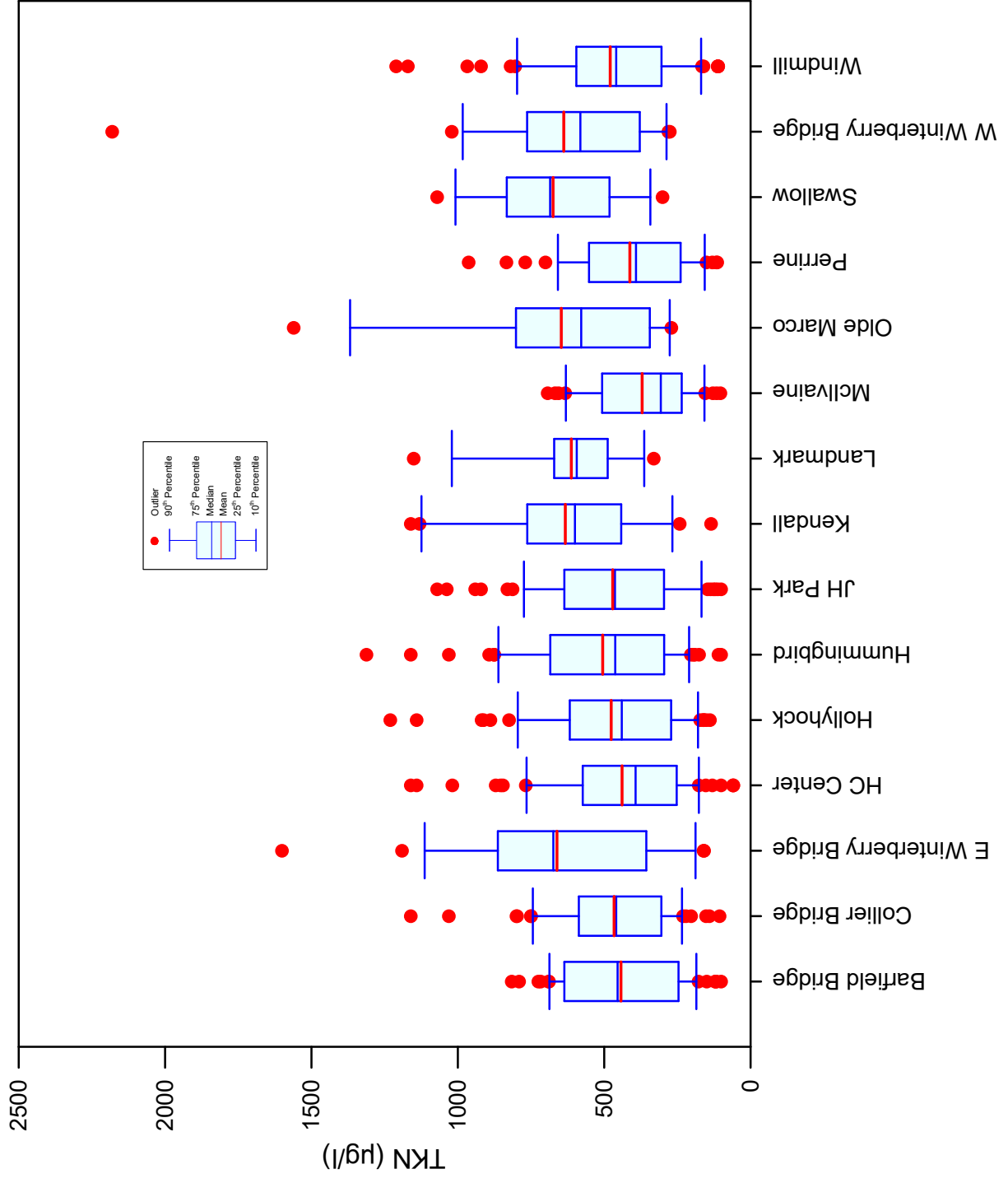

TKN

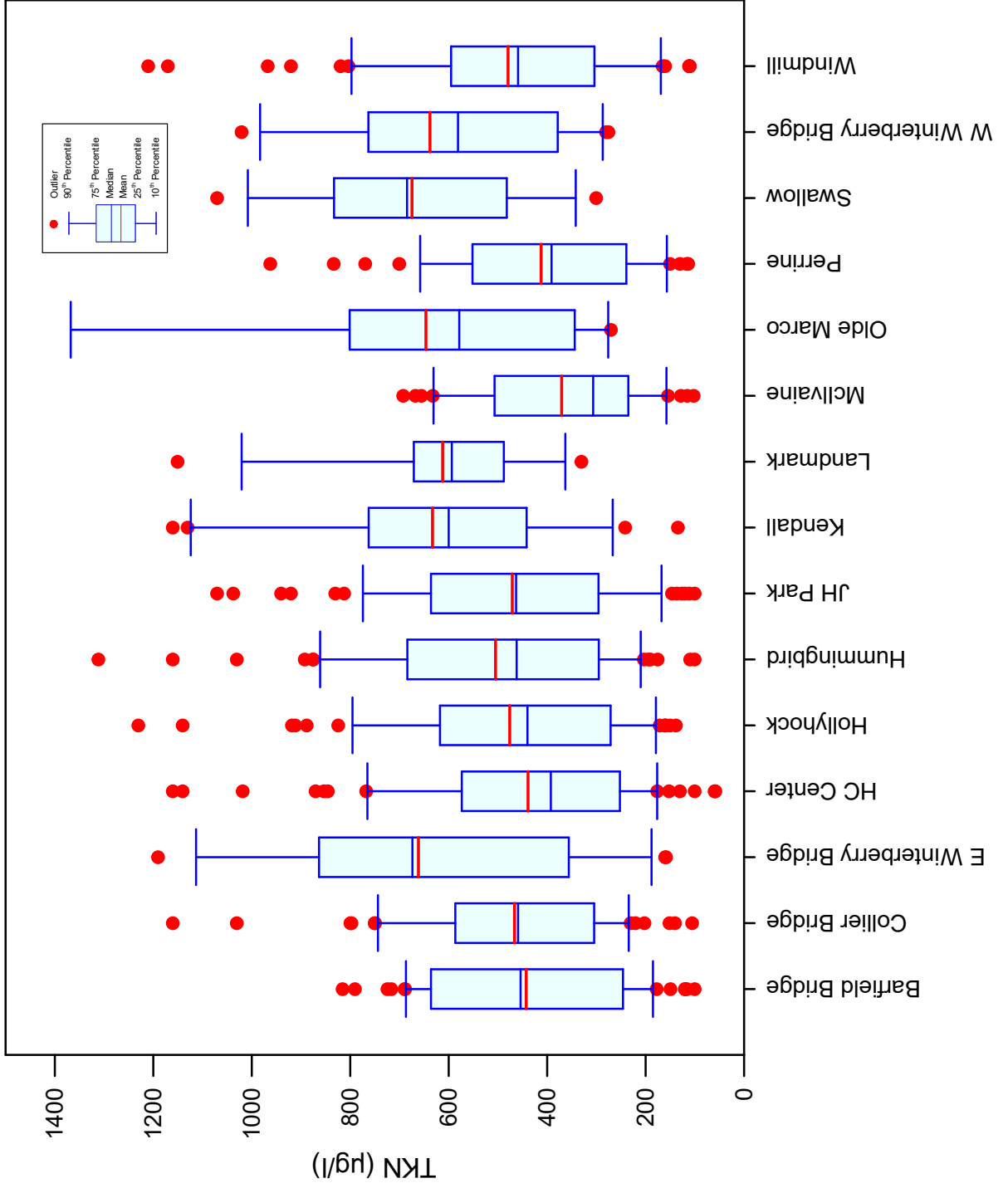

Total Nitrogen

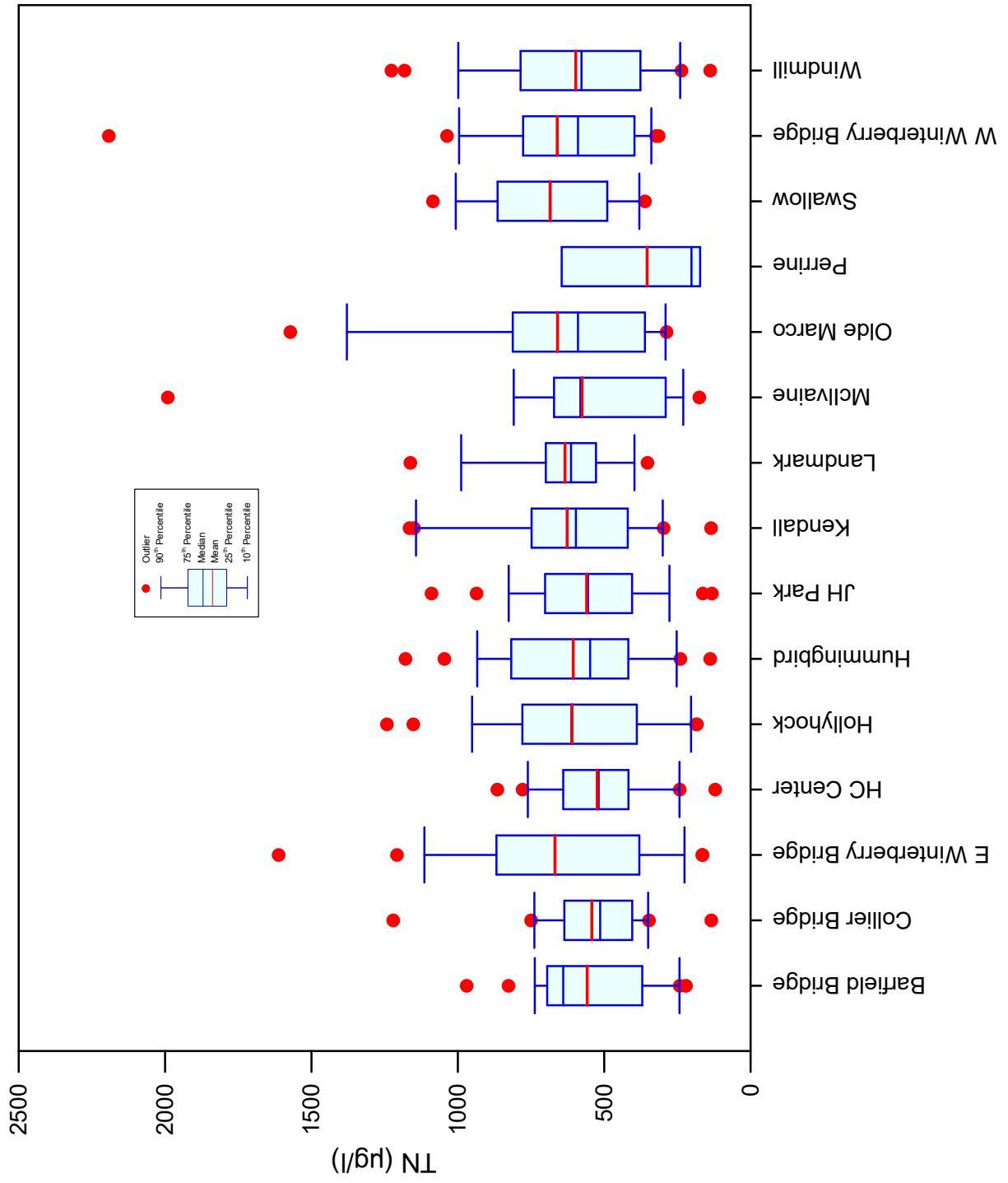

Total Nitrogen

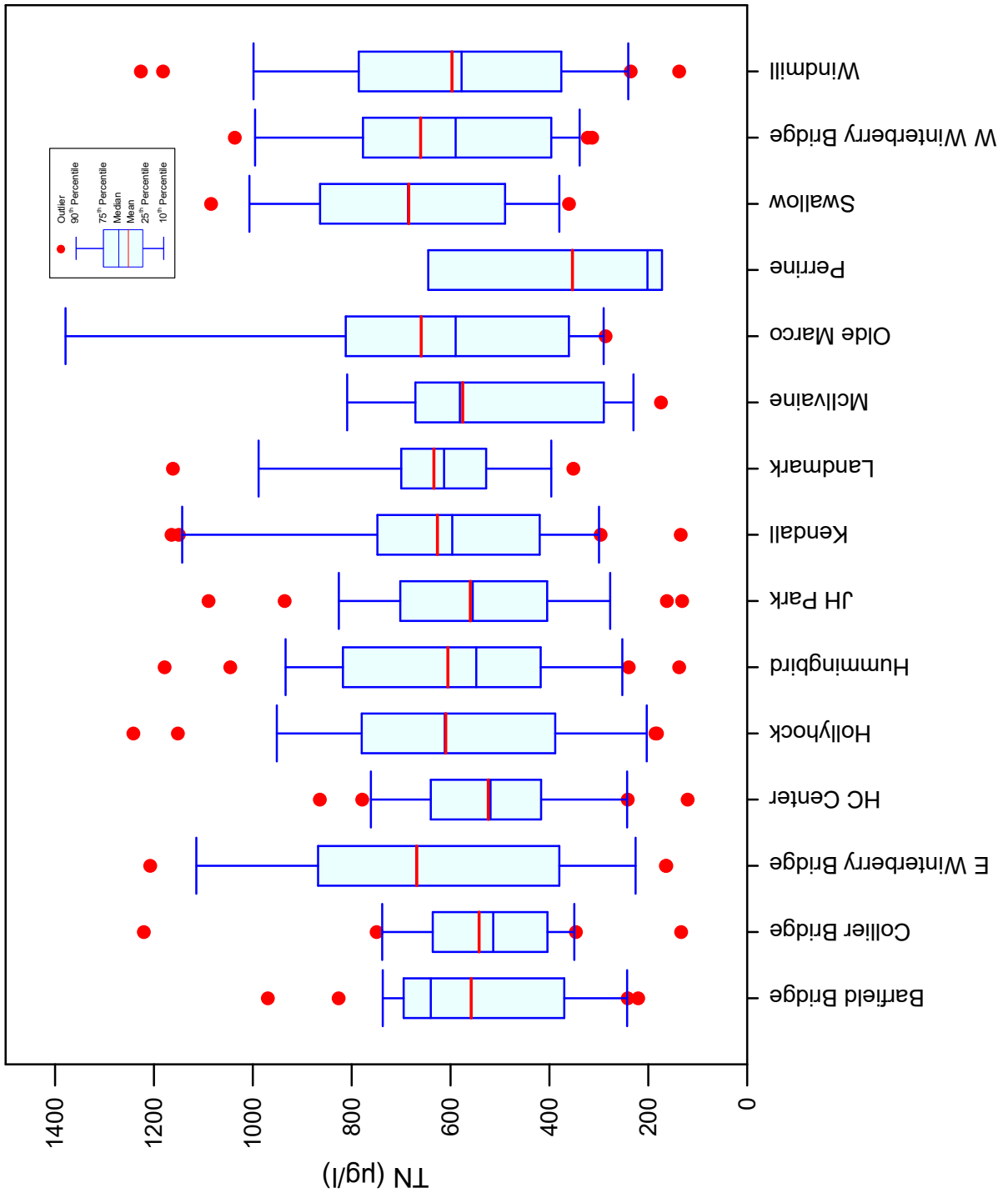

Total Phosphorus

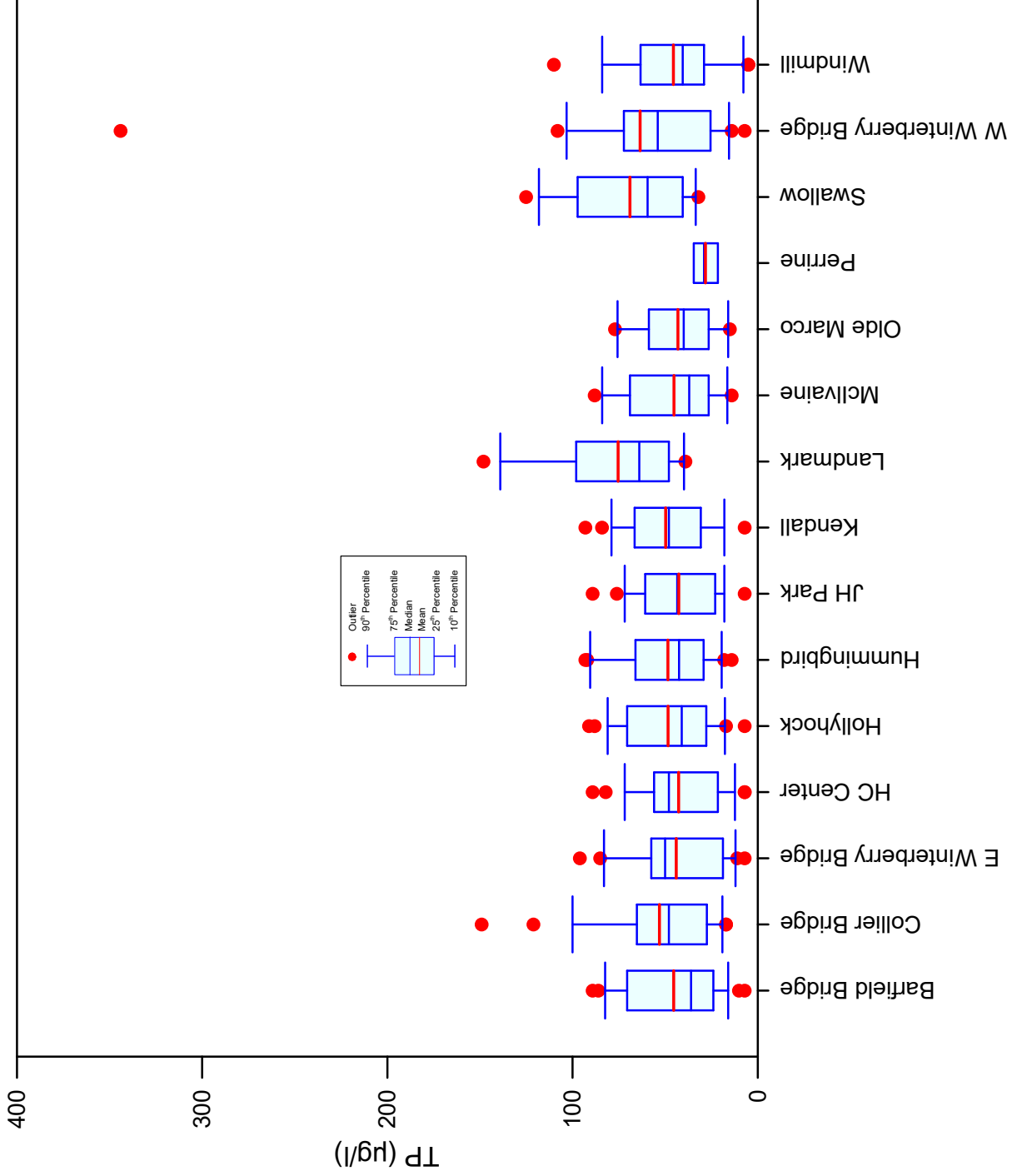

Total Phosphorus

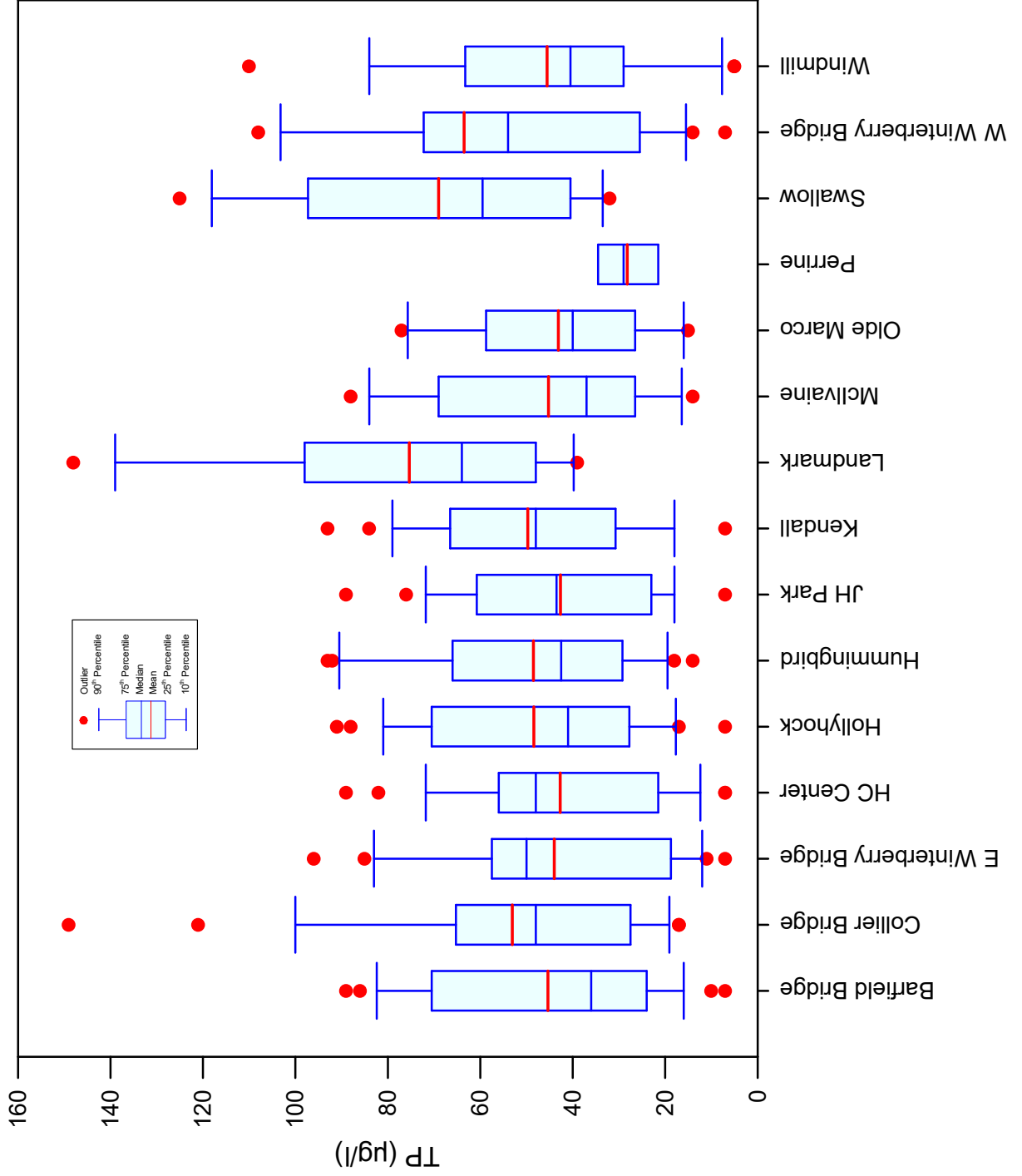

Turbidity

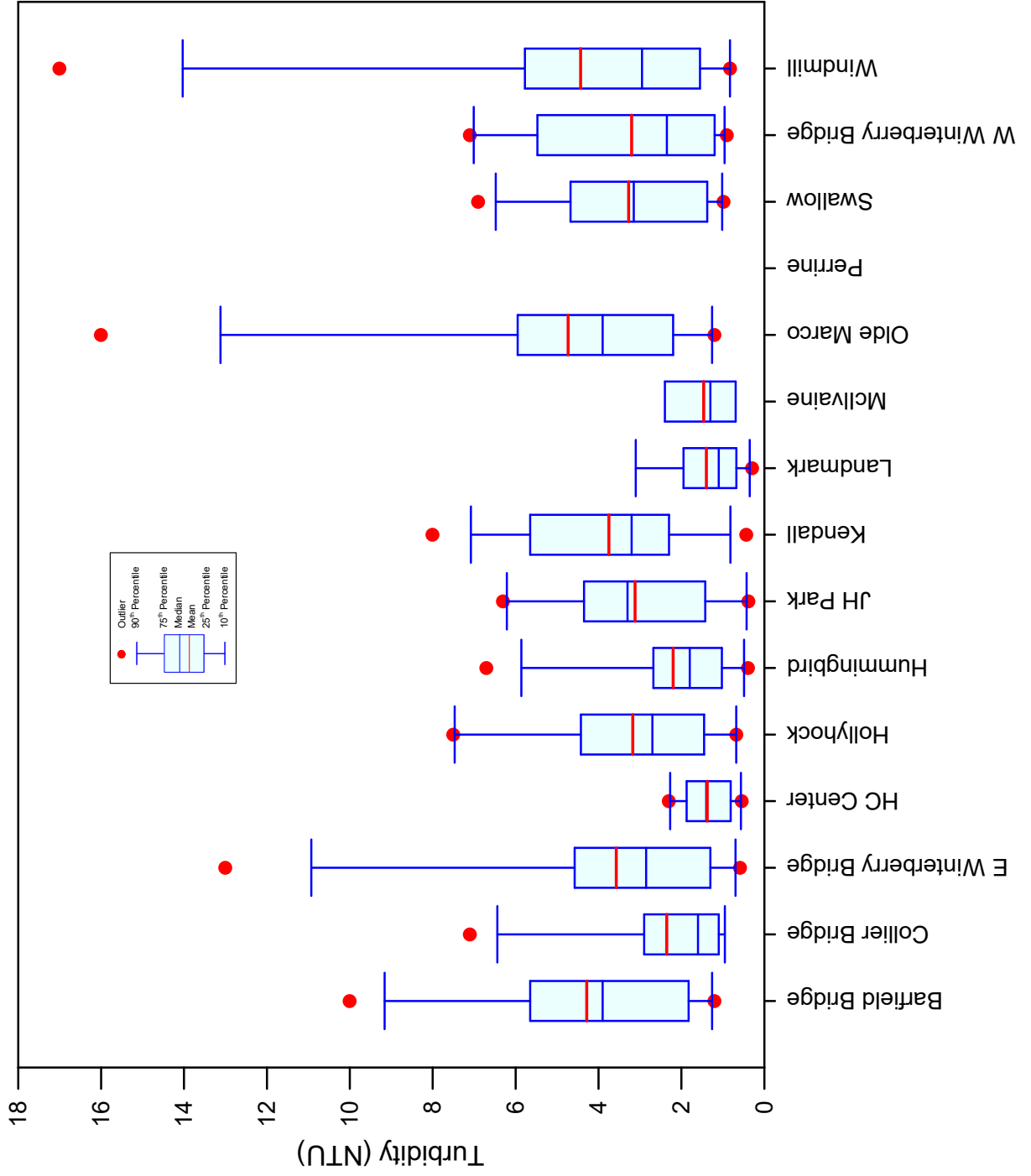

Chlorophyll - a

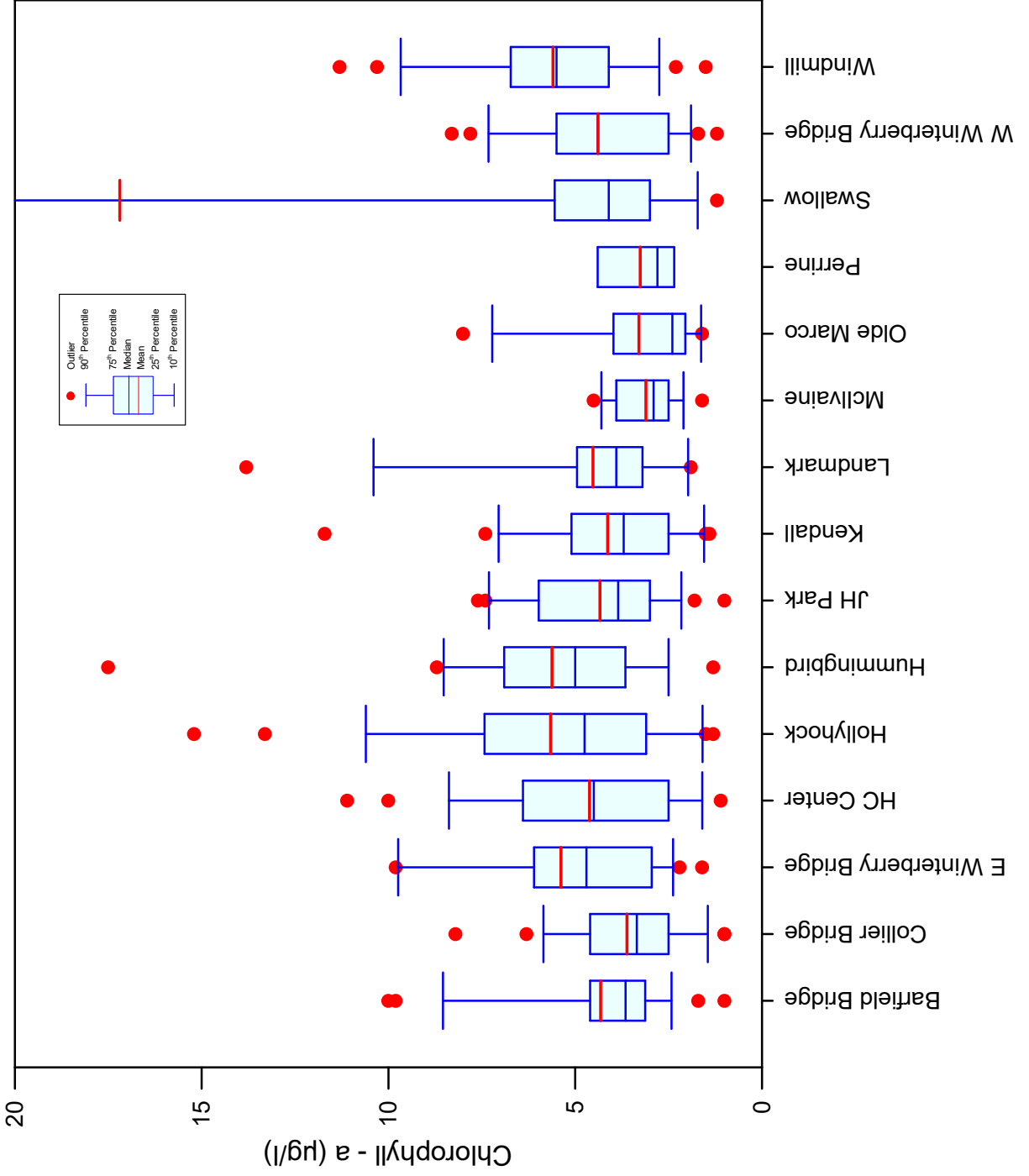

Secchi Depth

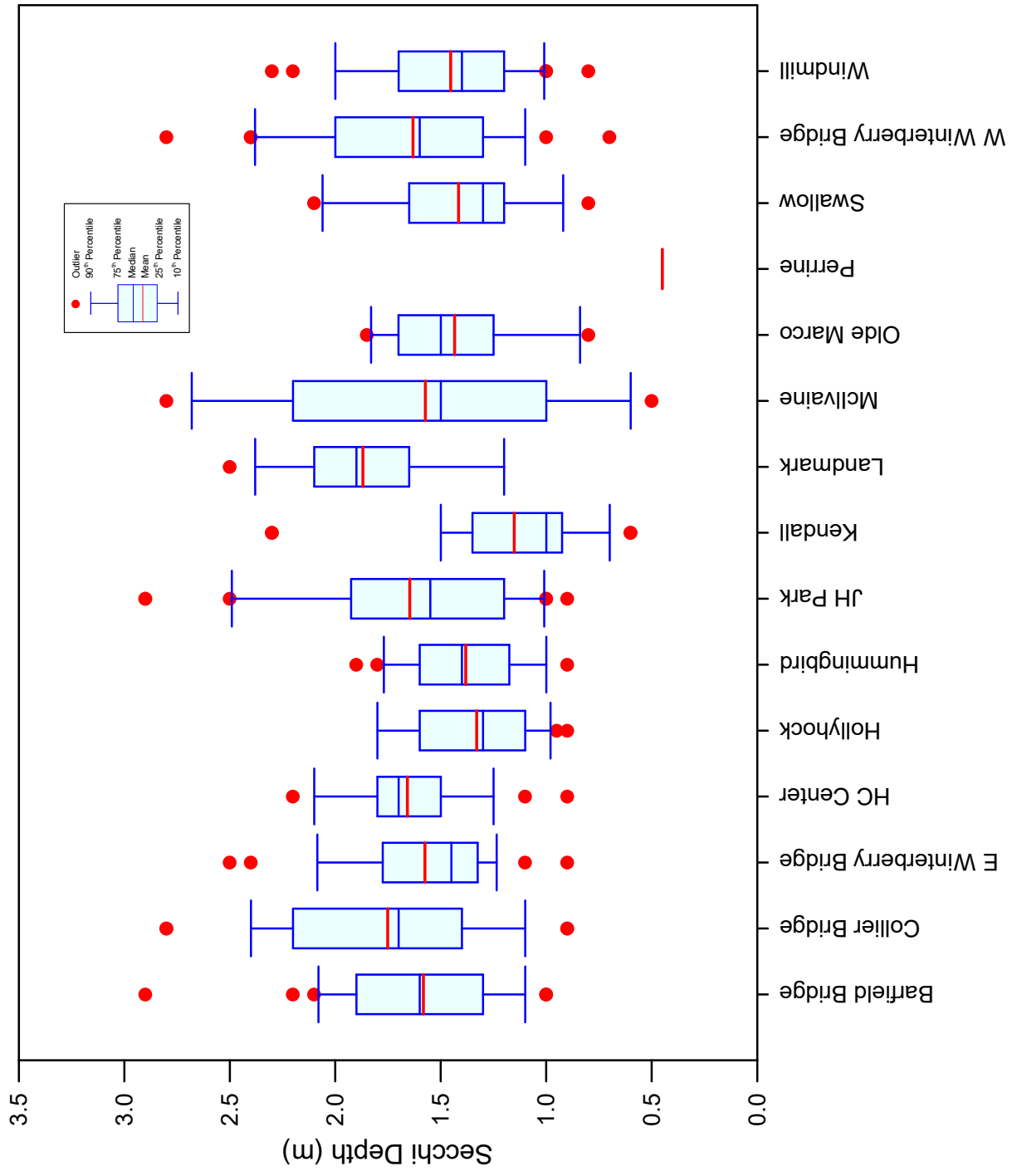

Enterococci

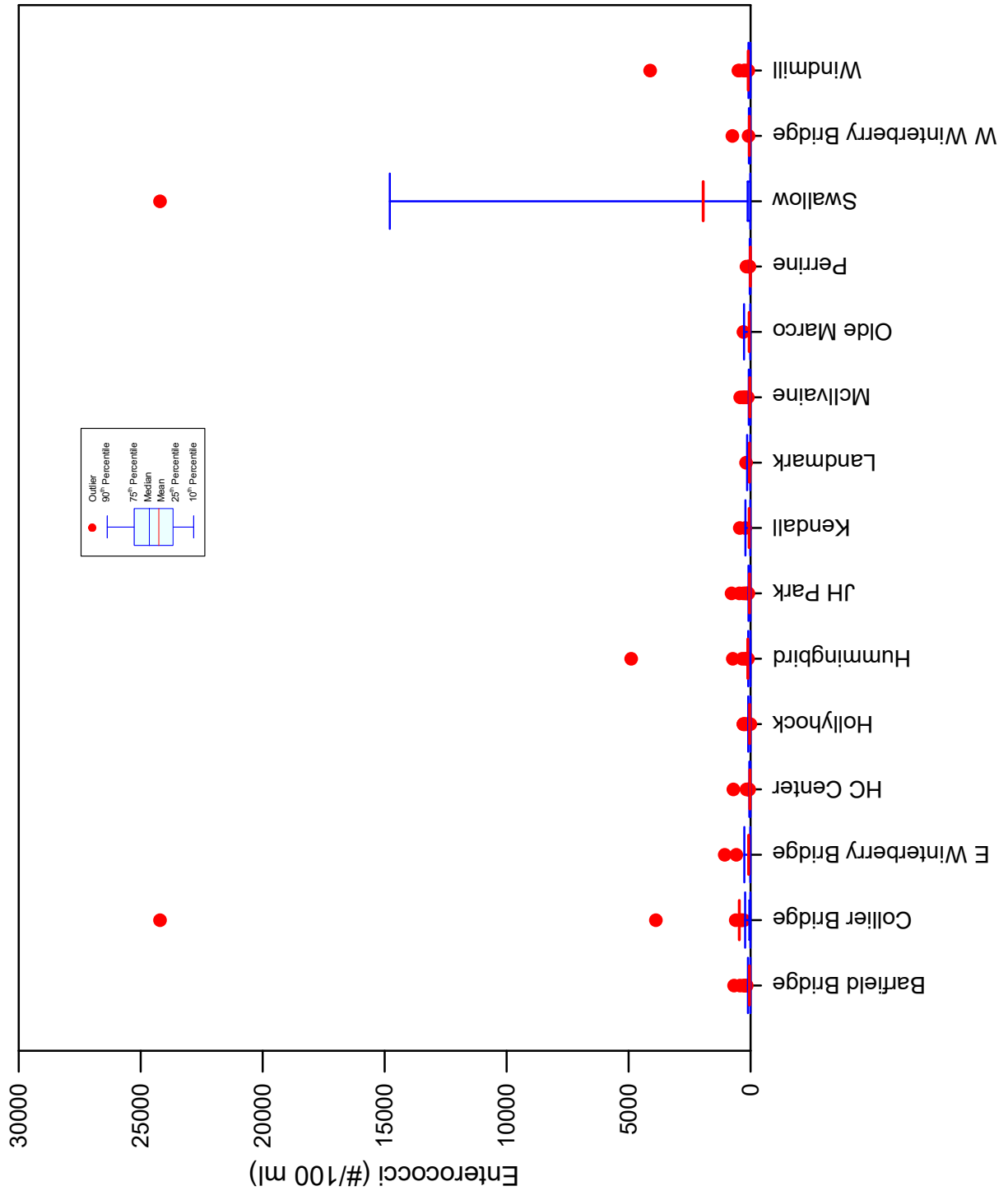

Enterococci

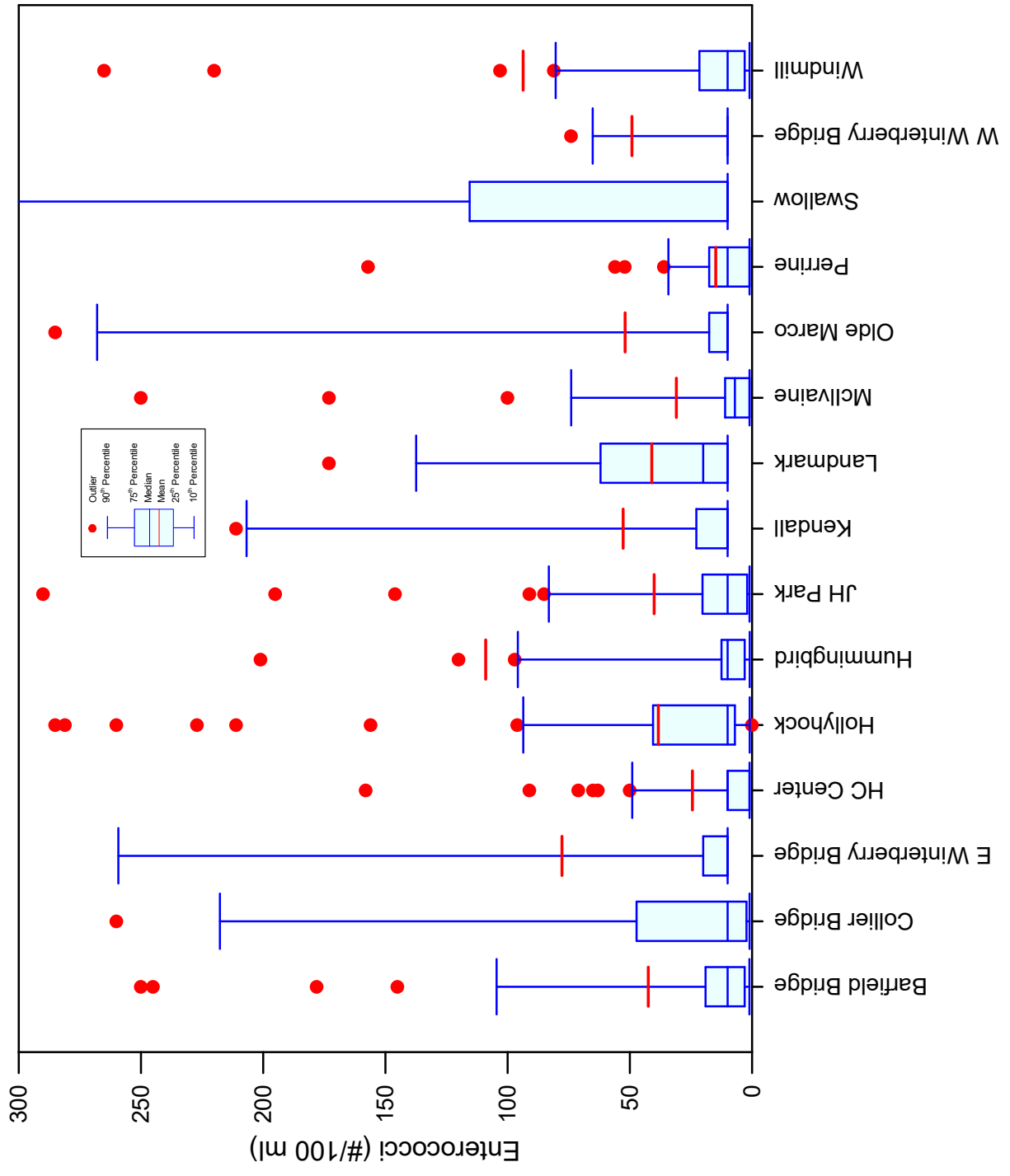

A-5: Historical Water Quality Data for Off-Shore Waterbodies

Historical Water Quality Data for Waterbodies Adjacent to Marco Island

| Collecting Agency | Station ID | Sample Date | pH (s.u.) | Temp. (°C) | Diss. O ₂ (mg/L) | Cond. (µmho/cm) | Salinity (ppt) | Ammonia N (µg/L) | NOx (µg/L) | TKN (µg/L) | Total N (µg/L) | Total P (µg/L) | Chyl-a (mg/m ³) | Turbidity (NTU) | Secchi Depth (m) | Enterococci (cfu/100 mL) | TOC (mg/L) |
|-------------------|------------|-------------|-----------|------------|-----------------------------|-----------------|----------------|------------------|------------|------------|----------------|----------------|-----------------------------|-----------------|------------------|--------------------------|------------|
| SFWMD | 16689 | 1/13/15 | 7.90 | 21.00 | 9.2 | 52,319 | 34.5 | 5 | 5 | | 155 | 18 | 1.8 | 2.9 | 1.9 | | 2.0 |
| SFWMD | 16689 | 3/5/15 | 7.80 | 21.30 | 7.4 | 51,368 | 33.8 | 13 | 5 | | 176 | 20 | 1.3 | 4.3 | 1.1 | | 2.7 |
| SFWMD | 16689 | 5/14/15 | 7.90 | 27.00 | 6.3 | 52,407 | 34.5 | 14 | 6 | | 200 | 20 | 2.0 | 1.0 | 3.4 | | 2.0 |
| SFWMD | 16689 | 7/7/15 | 8.00 | 30.00 | 5.3 | 53,080 | 34.9 | 5 | 7 | | 471 | 25 | 1.9 | 1.8 | 1.9 | | 2.4 |
| SFWMD | 16689 | 9/10/15 | 7.90 | 30.70 | 5.1 | 51,925 | 34.2 | 11 | 5 | | 318 | 21 | 2.4 | 2.4 | 2.3 | | 2.7 |
| SFWMD | 16689 | 11/3/15 | 7.80 | 28.10 | 6.4 | 50,373 | 32.9 | 9 | 1.4 | | 23 | 23 | 4.1 | 1.4 | 2.1 | | 3.1 |
| SFWMD | 16689 | 1/25/17 | 7.80 | 21.40 | 6.6 | 52,104 | 34.3 | 16 | 8 | | 416 | 93 | 4.2 | 36.8 | 0.3 | | 2.0 |
| SFWMD | 16689 | 3/6/17 | 8.10 | 21.40 | 7.3 | 52,456 | 34.6 | 5 | 5 | | 208 | 23 | 1.0 | 2.6 | 1.5 | | 2.1 |
| SFWMD | 16689 | 5/11/17 | 7.90 | 26.90 | 6.5 | 54,880 | 36.5 | 5 | 2.3 | | 22 | 22 | 1.7 | 2.3 | 2.5 | | 2.2 |
| SFWMD | 16689 | 7/18/17 | 8.00 | 30.10 | 5.7 | 46,567 | 30.1 | 11 | 5 | | 285 | 26 | 3.9 | 1.3 | 2.4 | | 3.2 |
| SFWMD | 16689 | 9/26/17 | 7.80 | 31.40 | 5.4 | 36,826 | 23.1 | 8 | 5 | | 631 | 77 | 11.5 | 3.5 | 0.6 | | 9.1 |
| SFWMD | 16689 | 11/16/17 | 7.90 | 23.70 | 6.4 | 52,237 | 34.5 | 5 | 5 | | 27 | 27 | 2.7 | 3.8 | 2.0 | | 2.0 |
| SFWMD | 16689 | 1/9/18 | 8.10 | 16.40 | 8.1 | 51,657 | 34.0 | 5 | 5 | | 246 | 19 | 2.0 | 2.5 | 2.5 | | 2.6 |
| SFWMD | 16689 | 5/8/18 | 8.10 | 26.80 | 6.6 | 56,596 | 37.6 | 5 | 5 | | 319 | 43 | 1.6 | 7.7 | 1.1 | | 2.9 |
| SFWMD | 16689 | 7/12/18 | 8.00 | 30.40 | 5.9 | 60,107 | 35.9 | 5 | 5 | | 30 | 30 | 4.2 | 1.3 | 2.5 | | 3.0 |
| SFWMD | 16689 | 9/17/18 | 7.80 | 31.10 | 5.1 | 49,588 | 32.3 | 5 | 5 | | 326 | 32 | 2.9 | 1.0 | 2.3 | | 4.1 |
| SFWMD | 16689 | 11/28/18 | 7.70 | 20.50 | 6.1 | 53,796 | 35.6 | 46 | 6 | | 401 | 37 | 3.5 | 5.7 | 1.1 | | 3.1 |
| SFWMD | 16689 | 1/15/19 | 8.00 | 19.90 | 7.5 | 53,595 | 35.5 | 5 | 5 | | 383 | 49 | 4.2 | 13.7 | | | 3.3 |
| SFWMD | 16689 | 3/12/19 | 8.00 | 24.50 | 7.1 | 52,304 | 34.5 | 5 | 5 | | 297 | 18 | 0.7 | 1.0 | 2.7 | | 1.7 |
| SFWMD | 16689 | 6/25/19 | 8.10 | 33.00 | 7.0 | 52,225 | 34.1 | 5 | 5 | | 315 | 33 | 3.6 | 2.5 | 1.6 | | 4.3 |
| SFWMD | 16689 | 7/31/19 | 8.10 | 31.40 | 5.8 | 52,912 | 34.7 | 6 | 5 | | 30 | 23 | 1.1 | 0.7 | 2.7 | | 3.2 |
| SFWMD | 16689 | 9/10/19 | 8.00 | 31.00 | 4.8 | 52,453 | 34.4 | 12 | 5 | | 224 | 23 | 2.4 | 0.9 | 3.0 | | 2.3 |
| SFWMD | 16689 | 11/19/19 | 8.10 | 21.70 | 7.6 | 51,682 | 34.0 | 5 | 5 | | 346 | 38 | 5.7 | 4.0 | 1.4 | | 3.2 |
| SFWMD | 16689 | 1/23/20 | 8.00 | 17.80 | 7.4 | 52,516 | 34.7 | 8 | 5 | | 60 | 60 | 1.5 | 15.0 | 0.7 | | 1.9 |
| SFWMD | 16689 | 3/10/20 | 7.90 | 20.30 | 7.5 | 52,645 | 34.8 | 5 | 5 | | 180 | 18 | 0.3 | 0.5 | 2.7 | | 2.3 |
| SFWMD | 16689 | 7/28/20 | 7.90 | 29.90 | 5.9 | 52,591 | 34.5 | 5 | 5 | | 302 | 28 | 3.4 | 2.9 | 4.0 | | 3.0 |
| SFWMD | 16689 | 9/29/20 | 7.90 | 29.70 | 5.6 | 51,321 | 33.6 | 17 | 5 | | 359 | 20 | 3.1 | 0.5 | 3.2 | | 3.4 |
| SFWMD | 16690 | 1/13/15 | 7.80 | 21.50 | 7.7 | 52,759 | 34.8 | 5 | 5 | | 247 | 33 | 1.2 | 6.4 | 1.5 | | 2.8 |
| SFWMD | 16690 | 3/5/15 | 7.80 | 23.70 | 6.4 | 49,942 | 32.7 | 15 | 6 | | 333 | 53 | 6.4 | 13.2 | 0.5 | | 3.9 |
| SFWMD | 16690 | 5/14/15 | 7.80 | 27.10 | 5.5 | 52,040 | 34.2 | 19 | 15 | | 392 | 29 | 3.3 | 3.3 | 1.3 | | 2.5 |
| SFWMD | 16690 | 7/7/15 | 8.00 | 29.60 | 5.7 | 53,529 | 35.2 | 5 | 9 | | 568 | 48 | 6.6 | 6.6 | 0.8 | | 4.1 |
| SFWMD | 16690 | 9/10/15 | 7.80 | 30.70 | 4.3 | 48,223 | 31.3 | 41 | 5 | | 449 | 36 | 9.0 | 5.1 | 1.2 | | 4.0 |
| SFWMD | 16690 | 11/3/15 | 7.70 | 28.50 | 6.0 | 49,092 | 32.0 | 15 | 14 | | 445 | 29 | | 3.8 | 1.4 | | 4.4 |
| SFWMD | 16690 | 1/25/17 | 7.80 | 21.30 | 6.4 | 52,040 | 34.3 | 24 | 10 | | 409 | 94 | 3.5 | 47.8 | 0.4 | | 1.8 |
| SFWMD | 16690 | 3/6/17 | 8.00 | 21.50 | 7.3 | 52,432 | 34.5 | 5 | 5 | | 222 | 22 | 1.3 | 4.1 | 1.6 | | 2.3 |
| SFWMD | 16690 | 5/11/17 | 7.90 | 27.50 | 7.7 | 55,633 | 36.7 | 13 | 5 | | 348 | 44 | 4.3 | 7.7 | 1.0 | | 2.8 |
| SFWMD | 16690 | 7/18/17 | 7.80 | 30.60 | 4.8 | 41,325 | 26.7 | 29 | 6 | | 394 | 47 | 7.2 | 6.0 | 1.7 | | 5.4 |
| SFWMD | 16690 | 9/26/17 | 7.20 | 30.20 | 5.1 | 42,346 | 28.7 | 10 | 5 | | 570 | 85 | 15.0 | 5.5 | 1.1 | | 6.0 |
| SFWMD | 16690 | 11/16/17 | 7.90 | 23.40 | 6.2 | 51,357 | 33.8 | 5 | 5 | | 322 | 41 | 3.8 | 7.0 | 1.3 | | 2.6 |
| SFWMD | 16690 | 1/9/18 | 8.00 | 16.30 | 8.2 | 52,419 | 34.6 | 11 | 7 | | 263 | 26 | 1.0 | 2.5 | 1.8 | | 2.7 |
| SFWMD | 16690 | 3/20/18 | 7.80 | 23.80 | 7.0 | 54,732 | 35.7 | 5 | 5 | | 310 | 33 | 3.1 | 3.4 | 1.2 | | 2.8 |
| SFWMD | 16690 | 5/8/18 | 8.00 | 27.10 | 6.3 | 56,802 | 37.7 | 5 | 7 | | 320 | 44 | 2.1 | 4.2 | 1.5 | | 3.2 |
| SFWMD | 16690 | 7/12/18 | 7.90 | 30.30 | 4.8 | 53,379 | 35.7 | 19 | 5 | | 396 | 41 | 2.8 | 1.7 | 1.6 | | 3.9 |
| SFWMD | 16690 | 9/17/18 | 7.80 | 31.60 | 4.9 | 48,308 | 31.3 | 8 | 5 | | 265 | 25 | 6.3 | 4.6 | 1.4 | | 5.5 |
| SFWMD | 16690 | 11/28/18 | 7.70 | 21.00 | 6.0 | 54,239 | 35.9 | 92 | 13 | | 407 | 42 | 2.3 | 4.8 | 1.4 | | 3.1 |
| SFWMD | 16690 | 1/15/19 | 7.80 | 20.10 | 6.8 | 54,100 | 35.8 | 20 | 6 | | 325 | 26 | 2.0 | 4.3 | 1.2 | | 3.3 |
| SFWMD | 16690 | 3/12/19 | 7.90 | 25.50 | 5.7 | 52,627 | 34.7 | 28 | 6 | | 386 | 34 | 1.6 | 5.9 | 1.2 | | 2.4 |
| SFWMD | 16690 | 6/25/19 | 7.90 | 33.30 | 5.7 | 48,655 | 31.5 | 5 | 5 | | 458 | 51 | 7.3 | 6.0 | 1.0 | | 5.5 |
| SFWMD | 16690 | 7/31/19 | 8.00 | 31.70 | 4.9 | 51,460 | 33.6 | 25 | 5 | | 35 | 35 | 2.2 | 3.6 | 0.9 | | 4.2 |
| SFWMD | 16690 | 9/10/19 | 7.90 | 31.10 | 5.1 | 50,168 | 32.6 | 11 | 5 | | 265 | 25 | 3.0 | 1.7 | 1.0 | | 2.9 |
| SFWMD | 16690 | 11/19/19 | 8.00 | 21.40 | 6.3 | 53,527 | 35.3 | 9 | 5 | | 374 | 38 | 5.5 | 2.9 | 0.7 | | 3.6 |
| SFWMD | 16690 | 1/23/20 | 7.90 | 16.70 | 7.3 | 52,448 | 34.6 | 13 | 7 | | 326 | 52 | 1.8 | 10.7 | 0.6 | | 2.1 |
| SFWMD | 16690 | 3/10/20 | 7.80 | 20.10 | 6.8 | 53,185 | 35.2 | 5 | 5 | | 279 | 41 | 1.0 | 8.0 | 1.1 | | 2.8 |
| SFWMD | 16690 | 5/26/20 | 7.80 | 27.70 | 5.3 | 53,644 | 35.4 | 5 | 5 | | 395 | 41 | 4.9 | 4.6 | 0.8 | | 3.4 |
| SFWMD | 16690 | 7/28/20 | 7.80 | 30.40 | 5.4 | 5,001 | 32.6 | 8 | 5 | | 425 | 41 | 6.5 | 6.2 | 2.4 | | 4.3 |
| SFWMD | 16690 | 9/29/20 | 7.80 | 30.10 | 4.9 | 49,741 | 32.4 | 27 | 5 | | 397 | 27 | 3.0 | 1.8 | 1.9 | | 4.0 |

Historical Water Quality Data for Waterbodies Adjacent to Marco Island

| Collecting Agency | Station ID | Sample Date | pH (s.u.) | Temp. (°C) | Diss. O ₂ (mg/L) | Cond. (µmho/cm) | Salinity (ppt) | Ammonia N (µg/L) | NOx (µg/L) | TKN (µg/L) | Total N (µg/L) | Total P (µg/L) | Chyl-a (mg/m ³) | Turbidity (NTU) | Secchi Depth (m) | Enterococci (cfu/100 mL) | TOC (mg/L) |
|-------------------|------------|-------------|-----------|------------|-----------------------------|-----------------|----------------|------------------|------------|------------|----------------|----------------|-----------------------------|-----------------|------------------|--------------------------|------------|
| SFWMD | 16692 | 1/13/15 | 7.80 | 21.20 | 7.2 | 52,925 | 35.0 | 9 | 5 | | 252 | 26 | 2.4 | 3.1 | 1.3 | | 3.2 |
| SFWMD | 16692 | 3/5/15 | 7.70 | 24.20 | 5.9 | 51,239 | 33.7 | 28 | 16 | | 444 | 66 | 5.8 | 13.9 | 0.5 | | 6.2 |
| SFWMD | 16692 | 5/14/15 | 7.70 | 27.30 | 4.7 | 53,277 | 35.1 | 46 | 17 | | 508 | 51 | | 8.3 | 0.7 | | 3.2 |
| SFWMD | 16692 | 7/7/15 | 8.00 | 29.30 | 5.1 | 35,499 | 35.2 | 11 | 7 | | 578 | 54 | | 7.9 | 0.8 | | 4.4 |
| SFWMD | 16692 | 9/10/15 | 7.80 | 30.70 | 4.2 | 46,935 | 30.4 | 40 | 11 | | 561 | 45 | | 10.1 | 0.6 | | 5.6 |
| SFWMD | 16692 | 11/3/15 | 7.60 | 28.50 | 4.3 | 44,552 | 28.8 | 47 | 283 | | 779 | 51 | | 4.7 | 1.0 | | 8.4 |
| SFWMD | 16692 | 1/25/17 | 7.70 | 21.30 | 6.3 | 52,447 | 34.6 | 28 | 9 | | 301 | 33 | 1.9 | 5.6 | 1.6 | | 2.2 |
| SFWMD | 16692 | 3/6/17 | 8.00 | 20.50 | 7.0 | 53,261 | 35.2 | 12 | 5 | | 330 | 39 | 3.7 | 8.1 | 1.7 | | 3.0 |
| SFWMD | 16692 | 5/11/17 | 7.80 | 27.30 | 5.4 | 56,236 | 37.5 | 21 | 5 | | 375 | 43 | 4.9 | 7.5 | 1.1 | | 3.3 |
| SFWMD | 16692 | 7/18/17 | 7.80 | 30.80 | 4.2 | 37,457 | 23.4 | 42 | 7 | | 566 | 72 | 7.2 | 4.4 | 0.5 | | 7.6 |
| SFWMD | 16692 | 9/26/17 | 7.60 | 30.30 | 3.3 | 40,678 | 24.5 | 13 | 5 | | 647 | 98 | 14.2 | 9.8 | 0.9 | | 8.4 |
| SFWMD | 16692 | 11/16/17 | 7.80 | 23.30 | 5.7 | 51,112 | 33.6 | 22 | 5 | | 424 | 55 | 5.5 | 13.1 | 1.1 | | 3.2 |
| SFWMD | 16692 | 1/9/18 | 8.00 | 16.40 | 8.2 | 52,853 | 34.9 | 12 | 5 | | 286 | 34 | 1.3 | 5.3 | 1.4 | | 2.8 |
| SFWMD | 16692 | 3/20/18 | 7.80 | 24.30 | 6.0 | 54,437 | 36.1 | 22 | 5 | | 323 | 39 | 1.4 | 4.1 | 1.0 | | 3.2 |
| SFWMD | 16692 | 5/8/18 | 7.90 | 27.60 | 5.9 | 57,215 | 38.0 | 10 | 5 | | 445 | 70 | 4.3 | 13.0 | 0.8 | | 3.9 |
| SFWMD | 16692 | 7/12/18 | 7.90 | 29.60 | 4.4 | 56,249 | 33.9 | 35 | 5 | | 520 | 58 | 3.3 | 7.3 | 1.0 | | 5.5 |
| SFWMD | 16692 | 9/17/18 | 7.80 | 31.60 | 4.7 | 41,701 | 26.8 | 43 | 15 | | 695 | 86 | 6.3 | 3.4 | 1.1 | | 10.7 |
| SFWMD | 16692 | 11/28/18 | 7.70 | 20.90 | 5.5 | 54,317 | 36.0 | 60 | 25 | | 392 | 42 | 2.4 | 5.6 | 1.1 | | 2.8 |
| SFWMD | 16692 | 1/15/19 | 7.80 | 19.70 | 6.6 | 54,437 | 36.1 | 30 | 11 | | 360 | 36 | 1.4 | 6.6 | 0.9 | | 3.6 |
| SFWMD | 16692 | 3/12/19 | 7.90 | 25.60 | 5.5 | 52,705 | 34.7 | 40 | 8 | | 456 | 46 | 2.6 | 8.6 | 0.9 | | 3.2 |
| SFWMD | 16692 | 6/25/19 | 7.80 | 33.10 | 4.9 | 47,444 | 30.4 | 6 | 5 | | 600 | 80 | 8.7 | 8.4 | 0.8 | | 7.5 |
| SFWMD | 16692 | 7/31/19 | 7.90 | 31.60 | 4.3 | 49,843 | 32.4 | 42 | 9 | | 530 | 66 | 3.6 | 11.2 | 0.9 | | 5.8 |
| SFWMD | 16692 | 9/10/19 | 7.80 | 31.00 | 3.7 | 48,018 | 40.0 | 66 | 6 | | 440 | 56 | 3.5 | 5.9 | 0.8 | | 5.2 |
| SFWMD | 16692 | 11/19/19 | 8.00 | 21.30 | 6.3 | 52,908 | 35.0 | 13 | 5 | | 363 | 42 | 4.3 | 4.3 | 0.6 | | 4.1 |
| SFWMD | 16692 | 1/23/20 | 7.90 | 16.80 | 7.2 | 52,611 | 34.7 | 19 | 8 | | 292 | 43 | 1.5 | 5.7 | 0.7 | | 2.2 |
| SFWMD | 16692 | 3/10/20 | 7.80 | 19.50 | 6.5 | 53,840 | 35.6 | 24 | 5 | | 336 | 45 | 1.4 | 7.9 | 1.0 | | 3.0 |
| SFWMD | 16692 | 5/26/20 | 7.70 | 27.50 | 5.3 | 54,759 | 36.2 | 8 | 5 | | 507 | 68 | 8.6 | 13.1 | 0.7 | | 4.3 |
| SFWMD | 16692 | 7/28/20 | 7.70 | 30.50 | 4.9 | 48,245 | 31.3 | 15 | 7 | | 553 | 59 | 8.2 | 11.3 | 2.0 | | 6.3 |
| SFWMD | 16692 | 9/29/20 | 7.60 | 29.90 | 3.5 | 44,077 | 28.3 | 64 | 8 | | 564 | 46 | 4.3 | 6.4 | 1.0 | | 6.6 |

Historical Water Quality Data for Waterbodies Adjacent to Marco Island

| Collecting Agency | Station ID | Sample Date | pH (s.u.) | Temp. (°C) | Diss. O ₂ (mg/L) | Cond. (µmho/cm) | Salinity (ppt) | Ammonia N (µg/L) | NOx (µg/L) | TKN (µg/L) | Total N (µg/L) | Total P (µg/L) | Chyl-a (mg/m ³) | Turbidity (NTU) | Secchi Depth (m) | Enterococci (cfu/100 mL) | TOC (mg/L) |
|-------------------|---------------|-------------|-----------|------------|-----------------------------|-----------------|----------------|------------------|------------|------------|----------------|----------------|-----------------------------|-----------------|------------------|--------------------------|------------|
| LAKWATCH | COL-JO-BAY1-1 | 4/25/01 | | | | | | | | | 340 | | | | 1.2 | | |
| LAKWATCH | COL-JO-BAY1-1 | 6/26/01 | | | | | | | | | 390 | | | | 1.1 | | |
| LAKWATCH | COL-JO-BAY1-1 | 8/24/01 | | | | | | | | | 270 | | | | 0.8 | | |
| LAKWATCH | COL-JO-BAY1-1 | 3/20/02 | | | | | | | | | 310 | | | | 1.1 | | |
| LAKWATCH | COL-JO-BAY1-1 | 7/29/02 | | | | | | | | | 310 | | | | 1.1 | | |
| LAKWATCH | COL-JO-BAY1-1 | 4/2/03 | | | | | | | | | 340 | | | | | | |
| LAKWATCH | COL-JO-BAY1-1 | 7/29/03 | | | | | | | | | 190 | | | | | | |
| LAKWATCH | COL-JO-BAY1-1 | 10/9/03 | | | | | | | | | 150 | | | | | | |
| LAKWATCH | COL-JO-BAY1-1 | 12/12/03 | | | | | | | | | 140 | | | | 1.4 | | |
| LAKWATCH | COL-JO-BAY1-1 | 12/22/03 | | | | | | | | | 200 | | | | 1.6 | | |
| LAKWATCH | COL-JO-BAY1-1 | 2/12/04 | | | | | | | | | 230 | | | | | | |
| LAKWATCH | COL-JO-BAY1-1 | 4/7/04 | | | | | | | | | 150 | | | | 1.7 | | |
| LAKWATCH | COL-JO-BAY1-1 | 6/9/04 | | | | | | | | | 150 | | | | 1.2 | | |
| LAKWATCH | COL-JO-BAY1-1 | 8/31/04 | | | | | | | | | 400 | | | | 1.2 | | |
| LAKWATCH | COL-JO-BAY1-1 | 11/19/04 | | | | | | | | | 400 | | | | 0.6 | | |
| LAKWATCH | COL-JO-BAY1-1 | 2/23/05 | | | | | | | | | 290 | | | | 1.3 | | |
| LAKWATCH | COL-JO-BAY1-1 | 5/18/05 | | | | | | | | | 230 | | | | 1.6 | | |
| LAKWATCH | COL-JO-BAY1-1 | 8/16/05 | | | | | | | | | 350 | | | | 1.2 | | |
| LAKWATCH | COL-JO-BAY1-1 | 11/30/05 | | | | | | | | | 430 | | | | 1.1 | | |
| LAKWATCH | COL-JO-BAY1-1 | 2/24/06 | | | | | | | | | 190 | | | | 1.2 | | |
| LAKWATCH | COL-JO-BAY1-1 | 5/26/06 | | | | | | | | | 270 | | | | 1.4 | | |
| LAKWATCH | COL-JO-BAY1-1 | 9/7/06 | | | | | | | | | 260 | | | | 1.6 | | |
| LAKWATCH | COL-JO-BAY1-1 | 11/20/06 | | | | | | | | | 330 | | | | 1.1 | | |
| LAKWATCH | COL-JO-BAY1-1 | 2/21/07 | | | | | | | | | 250 | | | | 1.1 | | |
| LAKWATCH | COL-JO-BAY1-1 | 5/29/07 | | | | | | | | | 250 | | | | 2.2 | | |
| LAKWATCH | COL-JO-BAY1-1 | 8/21/07 | | | | | | | | | 400 | | | | 1.2 | | |
| LAKWATCH | COL-JO-BAY1-1 | 11/30/07 | | | | | | | | | 480 | | | | | | |
| LAKWATCH | COL-JO-BAY1-1 | 2/29/08 | | | | | | | | | 250 | | | | 1.3 | | |
| LAKWATCH | COL-JO-BAY1-1 | 5/29/08 | | | | | | | | | 240 | | | | | | |
| LAKWATCH | COL-JO-BAY1-1 | 8/26/08 | | | | | | | | | 360 | | | | 1.2 | | |
| LAKWATCH | COL-JO-BAY1-1 | 11/25/08 | | | | | | | | | 260 | | | | | | |
| LAKWATCH | COL-JO-BAY1-1 | 2/20/09 | | | | | | | | | 360 | | | | 0.9 | | |
| LAKWATCH | COL-JO-BAY1-1 | 6/11/09 | | | | | | | | | 320 | | | | 1.5 | | |
| LAKWATCH | COL-JO-BAY1-1 | 9/14/09 | | | | | | | | | 430 | | | | 1.6 | | |
| LAKWATCH | COL-JO-BAY1-1 | 12/9/09 | | | | | | | | | 380 | | | | 1.8 | | |
| LAKWATCH | COL-JO-BAY1-1 | 3/23/10 | | | | | | | | | 340 | | | | 0.9 | | |
| LAKWATCH | COL-JO-BAY1-1 | 6/15/10 | | | | | | | | | 250 | | | | 1.4 | | |
| LAKWATCH | COL-JO-BAY1-1 | 9/23/10 | | | | | | | | | 430 | | | | 0.8 | | |
| LAKWATCH | COL-JO-BAY1-1 | 12/16/10 | | | | | | | | | 290 | | | | 0.6 | | |
| LAKWATCH | COL-JO-BAY1-1 | 3/31/11 | | | | | | | | | 400 | | | | 0.6 | | |
| LAKWATCH | COL-JO-BAY1-1 | 6/24/11 | | | | | | | | | 310 | | | | 1.5 | | |
| LAKWATCH | COL-JO-BAY1-1 | 9/14/11 | | | | | | | | | 510 | | | | 1.6 | | |
| LAKWATCH | COL-JO-BAY1-1 | 12/20/11 | | | | | | | | | 300 | | | | 1.2 | | |

Historical Water Quality Data for Waterbodies Adjacent to Marco Island

| Collecting Agency | Station ID | Sample Date | pH (s.u.) | Temp. (°C) | Diss. O ₂ (mg/L) | Cond. (µmho/cm) | Salinity (ppt) | Ammonia N (µg/L) | NOx (µg/L) | TKN (µg/L) | Total N (µg/L) | Total P (µg/L) | Chyl-a (mg/m ³) | Turbidity (NTU) | Secchi Depth (m) | Entero (cfu/100 mL) | TOC (mg/L) |
|-------------------|---------------|-------------|-----------|------------|-----------------------------|-----------------|----------------|------------------|------------|------------|----------------|----------------|-----------------------------|-----------------|------------------|---------------------|------------|
| LAKEWATCH | COL-JO-BAY1-3 | 4/25/01 | | | | | | | | | 460 | | | | 1.2 | | |
| LAKEWATCH | COL-JO-BAY1-3 | 6/26/01 | | | | | | | | | 320 | | | | | | |
| LAKEWATCH | COL-JO-BAY1-3 | 8/24/01 | | | | | | | | | 200 | | | | | | |
| LAKEWATCH | COL-JO-BAY1-3 | 3/20/02 | | | | | | | | | 300 | | | | 0.8 | | |
| LAKEWATCH | COL-JO-BAY1-3 | 7/29/02 | | | | | | | | | 340 | | | | | | |
| LAKEWATCH | COL-JO-BAY1-3 | 4/2/03 | | | | | | | | | 300 | | | | | | |
| LAKEWATCH | COL-JO-BAY1-3 | 7/29/03 | | | | | | | | | 190 | | | | | | |
| LAKEWATCH | COL-JO-BAY1-3 | 10/9/03 | | | | | | | | | 150 | | | | | | |
| LAKEWATCH | COL-JO-BAY1-3 | 12/12/03 | | | | | | | | | 190 | | | | | | |
| LAKEWATCH | COL-JO-BAY1-3 | 12/22/03 | | | | | | | | | 140 | | | | | | |
| LAKEWATCH | COL-JO-BAY1-3 | 2/12/04 | | | | | | | | | 220 | | | | | | |
| LAKEWATCH | COL-JO-BAY1-3 | 4/7/04 | | | | | | | | | 110 | | | | | | |
| LAKEWATCH | COL-JO-BAY1-3 | 6/9/04 | | | | | | | | | 160 | | | | | | |
| LAKEWATCH | COL-JO-BAY1-3 | 8/31/04 | | | | | | | | | 380 | | | | | | |
| LAKEWATCH | COL-JO-BAY1-3 | 11/19/04 | | | | | | | | | 360 | | | | | | |
| LAKEWATCH | COL-JO-BAY1-3 | 2/23/05 | | | | | | | | | 280 | | | | | | |
| LAKEWATCH | COL-JO-BAY1-3 | 5/18/05 | | | | | | | | | 250 | | | | | | |
| LAKEWATCH | COL-JO-BAY1-3 | 8/16/05 | | | | | | | | | 280 | | | | | | |
| LAKEWATCH | COL-JO-BAY1-3 | 11/30/05 | | | | | | | | | 450 | | | | | | |
| LAKEWATCH | COL-JO-BAY1-3 | 2/24/06 | | | | | | | | | 210 | | | | | | |
| LAKEWATCH | COL-JO-BAY1-3 | 5/26/06 | | | | | | | | | 270 | | | | | | |
| LAKEWATCH | COL-JO-BAY1-3 | 9/7/06 | | | | | | | | | 270 | | | | | | |
| LAKEWATCH | COL-JO-BAY1-3 | 11/20/06 | | | | | | | | | 310 | | | | | | |
| LAKEWATCH | COL-JO-BAY1-3 | 2/21/07 | | | | | | | | | 230 | | | | | | |
| LAKEWATCH | COL-JO-BAY1-3 | 5/29/07 | | | | | | | | | 210 | | | | | | |
| LAKEWATCH | COL-JO-BAY1-3 | 8/21/07 | | | | | | | | | 370 | | | | | | |
| LAKEWATCH | COL-JO-BAY1-3 | 11/30/07 | | | | | | | | | 470 | | | | | | |
| LAKEWATCH | COL-JO-BAY1-3 | 2/29/08 | | | | | | | | | 240 | | | | | | |
| LAKEWATCH | COL-JO-BAY1-3 | 5/29/08 | | | | | | | | | 270 | | | | | | |
| LAKEWATCH | COL-JO-BAY1-3 | 8/26/08 | | | | | | | | | 420 | | | | | | |
| LAKEWATCH | COL-JO-BAY1-3 | 11/25/08 | | | | | | | | | 240 | | | | | | |
| LAKEWATCH | COL-JO-BAY1-3 | 2/20/09 | | | | | | | | | 330 | | | | | | |
| LAKEWATCH | COL-JO-BAY1-3 | 6/11/09 | | | | | | | | | 340 | | | | | | |
| LAKEWATCH | COL-JO-BAY1-3 | 9/14/09 | | | | | | | | | 370 | | | | | | |
| LAKEWATCH | COL-JO-BAY1-3 | 12/9/09 | | | | | | | | | 410 | | | | | | |
| LAKEWATCH | COL-JO-BAY1-3 | 3/23/10 | | | | | | | | | 310 | | | | | | |
| LAKEWATCH | COL-JO-BAY1-3 | 6/15/10 | | | | | | | | | 240 | | | | | | |
| LAKEWATCH | COL-JO-BAY1-3 | 9/23/10 | | | | | | | | | 440 | | | | | | |
| LAKEWATCH | COL-JO-BAY1-3 | 12/16/10 | | | | | | | | | 300 | | | | | | |
| LAKEWATCH | COL-JO-BAY1-3 | 3/31/11 | | | | | | | | | 360 | | | | | | |
| LAKEWATCH | COL-JO-BAY1-3 | 6/24/11 | | | | | | | | | 300 | | | | | | |
| LAKEWATCH | COL-JO-BAY1-3 | 9/14/11 | | | | | | | | | 500 | | | | | | |
| LAKEWATCH | COL-JO-BAY1-3 | 12/20/11 | | | | | | | | | 270 | | | | | | |

Historical Water Quality Data for Waterbodies Adjacent to Marco Island

| Collecting Agency | Station ID | Sample Date | pH (s.u.) | Temp. (°C) | Diss. O ₂ (mg/L) | Cond. (µmho/cm) | Salinity (ppt) | Ammonia N (µg/L) | NOx (µg/L) | TKN (µg/L) | Total N (µg/L) | Total P (µg/L) | Chyl-a (mg/m ³) | Turbidity (NTU) | Secchi Depth (m) | Entero (cfu/100 mL) | TOC (mg/L) |
|-------------------|---------------|-------------|-----------|------------|-----------------------------|-----------------|----------------|------------------|------------|------------|----------------|----------------|-----------------------------|-----------------|------------------|---------------------|------------|
| LAKWATCH | COL-JO-BAY2-1 | 4/25/01 | | | | | | | | | 310 | | | | | | |
| LAKWATCH | COL-JO-BAY2-1 | 6/26/01 | | | | | | | | | 400 | | | | | | |
| LAKWATCH | COL-JO-BAY2-1 | 8/24/01 | | | | | | | | | 330 | | | | 0.8 | | |
| LAKWATCH | COL-JO-BAY2-1 | 3/20/02 | | | | | | | | | 290 | | | | 0.7 | | |
| LAKWATCH | COL-JO-BAY2-1 | 7/29/02 | | | | | | | | | 300 | | | | 1.2 | | |
| LAKWATCH | COL-JO-BAY2-1 | 7/29/03 | | | | | | | | | 190 | | | | | | |
| LAKWATCH | COL-JO-BAY2-1 | 10/9/03 | | | | | | | | | 180 | | | | | | |
| LAKWATCH | COL-JO-BAY2-1 | 12/12/03 | | | | | | | | | 180 | | | | | | |
| LAKWATCH | COL-JO-BAY2-1 | 12/22/03 | | | | | | | | | 150 | | | | | | |
| LAKWATCH | COL-JO-BAY2-1 | 2/12/04 | | | | | | | | | 240 | | | | | | |
| LAKWATCH | COL-JO-BAY2-1 | 4/7/04 | | | | | | | | | 140 | | | | | | |
| LAKWATCH | COL-JO-BAY2-1 | 6/8/04 | | | | | | | | | 200 | | | | 1.2 | | |
| LAKWATCH | COL-JO-BAY2-1 | 8/31/04 | | | | | | | | | 420 | | | | | | |
| LAKWATCH | COL-JO-BAY2-1 | 11/19/04 | | | | | | | | | 310 | | | | | | |
| LAKWATCH | COL-JO-BAY2-1 | 2/23/05 | | | | | | | | | 220 | | | | | | |
| LAKWATCH | COL-JO-BAY2-1 | 5/18/05 | | | | | | | | | 280 | | | | | | |
| LAKWATCH | COL-JO-BAY2-1 | 8/16/05 | | | | | | | | | 290 | | | | 1.4 | | |
| LAKWATCH | COL-JO-BAY2-1 | 11/30/05 | | | | | | | | | 440 | | | | 0.6 | | |
| LAKWATCH | COL-JO-BAY2-1 | 2/24/06 | | | | | | | | | 170 | | | | | | |
| LAKWATCH | COL-JO-BAY2-1 | 5/26/06 | | | | | | | | | 250 | | | | | | |
| LAKWATCH | COL-JO-BAY2-1 | 9/7/06 | | | | | | | | | 270 | | | | 1.6 | | |
| LAKWATCH | COL-JO-BAY2-1 | 11/20/06 | | | | | | | | | 300 | | | | | | |
| LAKWATCH | COL-JO-BAY2-1 | 2/21/07 | | | | | | | | | 290 | | | | 1.1 | | |
| LAKWATCH | COL-JO-BAY2-1 | 5/29/07 | | | | | | | | | 180 | | | | | | |
| LAKWATCH | COL-JO-BAY2-1 | 8/21/07 | | | | | | | | | 510 | | | | | | |
| LAKWATCH | COL-JO-BAY2-1 | 11/30/07 | | | | | | | | | 440 | | | | | | |
| LAKWATCH | COL-JO-BAY2-1 | 2/29/08 | | | | | | | | | 270 | | | | | | |
| LAKWATCH | COL-JO-BAY2-1 | 5/29/08 | | | | | | | | | 290 | | | | | | |
| LAKWATCH | COL-JO-BAY2-1 | 8/26/08 | | | | | | | | | 470 | | | | 1.2 | | |
| LAKWATCH | COL-JO-BAY2-1 | 11/25/08 | | | | | | | | | 270 | | | | | | |
| LAKWATCH | COL-JO-BAY2-1 | 2/20/09 | | | | | | | | | 340 | | | | 0.9 | | |
| LAKWATCH | COL-JO-BAY2-1 | 6/11/09 | | | | | | | | | 320 | | | | | | |
| LAKWATCH | COL-JO-BAY2-1 | 9/14/09 | | | | | | | | | 420 | | | | 1.7 | | |
| LAKWATCH | COL-JO-BAY2-1 | 12/9/09 | | | | | | | | | 460 | | | | | | |
| LAKWATCH | COL-JO-BAY2-1 | 3/23/10 | | | | | | | | | 320 | | | | | | |
| LAKWATCH | COL-JO-BAY2-1 | 6/15/10 | | | | | | | | | 260 | | | | | | |
| LAKWATCH | COL-JO-BAY2-1 | 9/23/10 | | | | | | | | | 400 | | | | | | |
| LAKWATCH | COL-JO-BAY2-1 | 12/16/10 | | | | | | | | | 300 | | | | 0.6 | | |
| LAKWATCH | COL-JO-BAY2-1 | 3/31/11 | | | | | | | | | 400 | | | | 0.6 | | |
| LAKWATCH | COL-JO-BAY2-1 | 6/24/11 | | | | | | | | | 300 | | | | | | |
| LAKWATCH | COL-JO-BAY2-1 | 9/14/11 | | | | | | | | | 470 | | | | | | |
| LAKWATCH | COL-JO-BAY2-1 | 12/20/11 | | | | | | | | | 270 | | | | | | |

Historical Water Quality Data for Waterbodies Adjacent to Marco Island

| Collecting Agency | Station ID | Sample Date | pH (s.u.) | Temp. (°C) | Diss. O ₂ (mg/L) | Cond. (µmho/cm) | Salinity (ppt) | Ammonia N (µg/L) | NOx (µg/L) | TKN (µg/L) | Total N (µg/L) | Total P (µg/L) | Chyl-a (mg/m ³) | Turbidity (NTU) | Secchi Depth (m) | Entero (cfu/100 mL) | TOC (mg/L) |
|-------------------|---------------|-------------|-----------|------------|-----------------------------|-----------------|----------------|------------------|------------|------------|----------------|----------------|-----------------------------|-----------------|------------------|---------------------|------------|
| LAKEWATCH | COL-JO-BAY2-2 | 4/25/01 | | | | | | | | | 300 | | | | | | |
| LAKEWATCH | COL-JO-BAY2-2 | 6/26/01 | | | | | | | | | 440 | | | | | | |
| LAKEWATCH | COL-JO-BAY2-2 | 8/24/01 | | | | | | | | | 360 | | | | 0.8 | | |
| LAKEWATCH | COL-JO-BAY2-2 | 3/20/02 | | | | | | | | | 280 | | | | 0.7 | | |
| LAKEWATCH | COL-JO-BAY2-2 | 7/29/02 | | | | | | | | | 330 | | | | | | |
| LAKEWATCH | COL-JO-BAY2-2 | 7/29/03 | | | | | | | | | 230 | | | | | | |
| LAKEWATCH | COL-JO-BAY2-2 | 10/9/03 | | | | | | | | | 180 | | | | | | |
| LAKEWATCH | COL-JO-BAY2-2 | 12/12/03 | | | | | | | | | 190 | | | | | | |
| LAKEWATCH | COL-JO-BAY2-2 | 12/22/03 | | | | | | | | | 140 | | | | | | |
| LAKEWATCH | COL-JO-BAY2-2 | 2/12/04 | | | | | | | | | 250 | | | | | | |
| LAKEWATCH | COL-JO-BAY2-2 | 6/8/04 | | | | | | | | | 220 | | | | | | |
| LAKEWATCH | COL-JO-BAY2-2 | 8/31/04 | | | | | | | | | 380 | | | | | | |
| LAKEWATCH | COL-JO-BAY2-2 | 11/19/04 | | | | | | | | | 290 | | | | | | |
| LAKEWATCH | COL-JO-BAY2-2 | 2/23/05 | | | | | | | | | 220 | | | | | | |
| LAKEWATCH | COL-JO-BAY2-2 | 5/18/05 | | | | | | | | | 260 | | | | | | |
| LAKEWATCH | COL-JO-BAY2-2 | 8/16/05 | | | | | | | | | 310 | | | | | | |
| LAKEWATCH | COL-JO-BAY2-2 | 11/30/05 | | | | | | | | | 420 | | | | | | |
| LAKEWATCH | COL-JO-BAY2-2 | 2/24/06 | | | | | | | | | 170 | | | | | | |
| LAKEWATCH | COL-JO-BAY2-2 | 5/26/06 | | | | | | | | | 270 | | | | | | |
| LAKEWATCH | COL-JO-BAY2-2 | 9/7/06 | | | | | | | | | 260 | | | | | | |
| LAKEWATCH | COL-JO-BAY2-2 | 11/20/06 | | | | | | | | | 290 | | | | | | |
| LAKEWATCH | COL-JO-BAY2-2 | 2/21/07 | | | | | | | | | 260 | | | | | | |
| LAKEWATCH | COL-JO-BAY2-2 | 5/29/07 | | | | | | | | | 240 | | | | | | |
| LAKEWATCH | COL-JO-BAY2-2 | 8/21/07 | | | | | | | | | 610 | | | | | | |
| LAKEWATCH | COL-JO-BAY2-2 | 11/30/07 | | | | | | | | | 440 | | | | | | |
| LAKEWATCH | COL-JO-BAY2-2 | 2/29/08 | | | | | | | | | 250 | | | | | | |
| LAKEWATCH | COL-JO-BAY2-2 | 5/29/08 | | | | | | | | | 300 | | | | | | |
| LAKEWATCH | COL-JO-BAY2-2 | 8/26/08 | | | | | | | | | 490 | | | | | | |
| LAKEWATCH | COL-JO-BAY2-2 | 11/25/08 | | | | | | | | | 280 | | | | | | |
| LAKEWATCH | COL-JO-BAY2-2 | 2/20/09 | | | | | | | | | 380 | | | | | | |
| LAKEWATCH | COL-JO-BAY2-2 | 6/11/09 | | | | | | | | | 290 | | | | | | |
| LAKEWATCH | COL-JO-BAY2-2 | 9/14/09 | | | | | | | | | 350 | | | | | | |
| LAKEWATCH | COL-JO-BAY2-2 | 12/9/09 | | | | | | | | | 480 | | | | | | |
| LAKEWATCH | COL-JO-BAY2-2 | 3/23/10 | | | | | | | | | 350 | | | | | | |
| LAKEWATCH | COL-JO-BAY2-2 | 6/15/10 | | | | | | | | | 290 | | | | | | |
| LAKEWATCH | COL-JO-BAY2-2 | 9/23/10 | | | | | | | | | 390 | | | | | | |
| LAKEWATCH | COL-JO-BAY2-2 | 12/16/10 | | | | | | | | | 300 | | | | | | |
| LAKEWATCH | COL-JO-BAY2-2 | 3/31/11 | | | | | | | | | 340 | | | | | | |
| LAKEWATCH | COL-JO-BAY2-2 | 6/24/11 | | | | | | | | | 320 | | | | | | |
| LAKEWATCH | COL-JO-BAY2-2 | 9/14/11 | | | | | | | | | 520 | | | | | | |
| LAKEWATCH | COL-JO-BAY2-2 | 12/20/11 | | | | | | | | | 270 | | | | | | |

Historical Water Quality Data for Waterbodies Adjacent to Marco Island

| Collecting Agency | Station ID | Sample Date | pH (s.u.) | Temp. (°C) | Diss. O ₂ (mg/L) | Cond. (µmho/cm) | Salinity (ppt) | Ammonia N (µg/L) | NOx (µg/L) | TKN (µg/L) | Total N (µg/L) | Total P (µg/L) | Chyl-a (mg/m ³) | Turbidity (NTU) | Secchi Depth (m) | Entero (cfu/100 mL) | TOC (mg/L) |
|-------------------|---------------|-------------|-----------|------------|-----------------------------|-----------------|----------------|------------------|------------|------------|----------------|----------------|-----------------------------|-----------------|------------------|---------------------|------------|
| LAKEWATCH | COL-JO-BAY2-3 | 4/25/01 | | | | | | | | | 250 | | | | | | |
| LAKEWATCH | COL-JO-BAY2-3 | 6/26/01 | | | | | | | | | 420 | | | | | | |
| LAKEWATCH | COL-JO-BAY2-3 | 8/24/01 | | | | | | | | | 410 | | | | 0.8 | | |
| LAKEWATCH | COL-JO-BAY2-3 | 3/20/02 | | | | | | | | | 340 | | | | 0.7 | | |
| LAKEWATCH | COL-JO-BAY2-3 | 7/29/02 | | | | | | | | | 330 | | | | | | |
| LAKEWATCH | COL-JO-BAY2-3 | 7/29/03 | | | | | | | | | 210 | | | | | | |
| LAKEWATCH | COL-JO-BAY2-3 | 10/9/03 | | | | | | | | | 180 | | | | | | |
| LAKEWATCH | COL-JO-BAY2-3 | 12/12/03 | | | | | | | | | 210 | | | | | | |
| LAKEWATCH | COL-JO-BAY2-3 | 12/22/03 | | | | | | | | | 180 | | | | | | |
| LAKEWATCH | COL-JO-BAY2-3 | 2/12/04 | | | | | | | | | 250 | | | | | | |
| LAKEWATCH | COL-JO-BAY2-3 | 6/8/04 | | | | | | | | | 240 | | | | | | |
| LAKEWATCH | COL-JO-BAY2-3 | 8/31/04 | | | | | | | | | 390 | | | | | | |
| LAKEWATCH | COL-JO-BAY2-3 | 11/19/04 | | | | | | | | | 330 | | | | | | |
| LAKEWATCH | COL-JO-BAY2-3 | 2/23/05 | | | | | | | | | 220 | | | | | | |
| LAKEWATCH | COL-JO-BAY2-3 | 5/18/05 | | | | | | | | | 290 | | | | | | |
| LAKEWATCH | COL-JO-BAY2-3 | 8/16/05 | | | | | | | | | 300 | | | | | | |
| LAKEWATCH | COL-JO-BAY2-3 | 11/30/05 | | | | | | | | | 420 | | | | | | |
| LAKEWATCH | COL-JO-BAY2-3 | 2/24/06 | | | | | | | | | 180 | | | | | | |
| LAKEWATCH | COL-JO-BAY2-3 | 5/26/06 | | | | | | | | | 270 | | | | | | |
| LAKEWATCH | COL-JO-BAY2-3 | 9/7/06 | | | | | | | | | 270 | | | | | | |
| LAKEWATCH | COL-JO-BAY2-3 | 11/20/06 | | | | | | | | | 310 | | | | | | |
| LAKEWATCH | COL-JO-BAY2-3 | 2/21/07 | | | | | | | | | 300 | | | | | | |
| LAKEWATCH | COL-JO-BAY2-3 | 5/29/07 | | | | | | | | | 250 | | | | | | |
| LAKEWATCH | COL-JO-BAY2-3 | 8/21/07 | | | | | | | | | 530 | | | | | | |
| LAKEWATCH | COL-JO-BAY2-3 | 11/30/07 | | | | | | | | | 480 | | | | | | |
| LAKEWATCH | COL-JO-BAY2-3 | 2/29/08 | | | | | | | | | 260 | | | | | | |
| LAKEWATCH | COL-JO-BAY2-3 | 5/29/08 | | | | | | | | | 310 | | | | | | |
| LAKEWATCH | COL-JO-BAY2-3 | 8/26/08 | | | | | | | | | 450 | | | | | | |
| LAKEWATCH | COL-JO-BAY2-3 | 11/25/08 | | | | | | | | | 220 | | | | | | |
| LAKEWATCH | COL-JO-BAY2-3 | 2/20/09 | | | | | | | | | 370 | | | | | | |
| LAKEWATCH | COL-JO-BAY2-3 | 6/11/09 | | | | | | | | | 320 | | | | | | |
| LAKEWATCH | COL-JO-BAY2-3 | 9/14/09 | | | | | | | | | 330 | | | | | | |
| LAKEWATCH | COL-JO-BAY2-3 | 12/9/09 | | | | | | | | | 450 | | | | | | |
| LAKEWATCH | COL-JO-BAY2-3 | 3/23/10 | | | | | | | | | 280 | | | | | | |
| LAKEWATCH | COL-JO-BAY2-3 | 6/15/10 | | | | | | | | | 330 | | | | | | |
| LAKEWATCH | COL-JO-BAY2-3 | 9/23/10 | | | | | | | | | 390 | | | | | | |
| LAKEWATCH | COL-JO-BAY2-3 | 12/16/10 | | | | | | | | | 290 | | | | | | |
| LAKEWATCH | COL-JO-BAY2-3 | 3/31/11 | | | | | | | | | 360 | | | | | | |
| LAKEWATCH | COL-JO-BAY2-3 | 6/24/11 | | | | | | | | | 260 | | | | | | |
| LAKEWATCH | COL-JO-BAY2-3 | 9/14/11 | | | | | | | | | 500 | | | | | | |
| LAKEWATCH | COL-JO-BAY2-3 | 12/20/11 | | | | | | | | | 280 | | | | | | |

Historical Water Quality Data for Waterbodies Adjacent to Marco Island

| Collecting Agency | Station ID | Sample Date | pH (s.u.) | Temp. (°C) | Diss. O ₂ (mg/L) | Cond. (µmho/cm) | Salinity (ppt) | Ammonia N (µg/L) | NOx (µg/L) | TKN (µg/L) | Total N (µg/L) | Total P (µg/L) | Chyl-a (mg/m ³) | Turbidity (NTU) | Secchi Depth (m) | Entero (cfu/100 mL) | TOC (mg/L) |
|-------------------|---------------|-------------|-----------|------------|-----------------------------|-----------------|----------------|------------------|------------|------------|----------------|----------------|-----------------------------|-----------------|------------------|---------------------|------------|
| LAKWATCH | COL-JO-BAY3-1 | 2/12/04 | | | | | | | | | 210 | | | | 1.9 | | |
| LAKWATCH | COL-JO-BAY3-1 | 4/7/04 | | | | | | | | | 120 | | | | 1.2 | | |
| LAKWATCH | COL-JO-BAY3-1 | 6/9/04 | | | | | | | | | 140 | | | | 1.7 | | |
| LAKWATCH | COL-JO-BAY3-1 | 8/31/04 | | | | | | | | | 320 | | | | 1.9 | | |
| LAKWATCH | COL-JO-BAY3-1 | 11/19/04 | | | | | | | | | 260 | | | | 1.9 | | |
| LAKWATCH | COL-JO-BAY3-1 | 2/23/05 | | | | | | | | | 210 | | | | 1.1 | | |
| LAKWATCH | COL-JO-BAY3-1 | 5/18/05 | | | | | | | | | 210 | | | | 1.9 | | |
| LAKWATCH | COL-JO-BAY3-1 | 8/16/05 | | | | | | | | | 340 | | | | 2.0 | | |
| LAKWATCH | COL-JO-BAY3-1 | 11/30/05 | | | | | | | | | 420 | | | | 1.2 | | |
| LAKWATCH | COL-JO-BAY3-1 | 2/24/06 | | | | | | | | | 240 | | | | 1.4 | | |
| LAKWATCH | COL-JO-BAY3-1 | 5/26/06 | | | | | | | | | 260 | | | | 2.5 | | |
| LAKWATCH | COL-JO-BAY3-1 | 9/7/06 | | | | | | | | | 270 | | | | 1.9 | | |
| LAKWATCH | COL-JO-BAY3-1 | 11/20/06 | | | | | | | | | 270 | | | | 0.9 | | |
| LAKWATCH | COL-JO-BAY3-1 | 2/21/07 | | | | | | | | | 230 | | | | 1.5 | | |
| LAKWATCH | COL-JO-BAY3-1 | 5/29/07 | | | | | | | | | 220 | | | | 1.4 | | |
| LAKWATCH | COL-JO-BAY3-1 | 8/21/07 | | | | | | | | | 430 | | | | 1.4 | | |
| LAKWATCH | COL-JO-BAY3-1 | 11/30/07 | | | | | | | | | 440 | | | | 1.7 | | |
| LAKWATCH | COL-JO-BAY3-1 | 2/29/08 | | | | | | | | | 230 | | | | 1.1 | | |
| LAKWATCH | COL-JO-BAY3-1 | 5/29/08 | | | | | | | | | 280 | | | | 1.2 | | |
| LAKWATCH | COL-JO-BAY3-1 | 8/26/08 | | | | | | | | | 360 | | | | 1.2 | | |
| LAKWATCH | COL-JO-BAY3-1 | 11/25/08 | | | | | | | | | 290 | | | | 1.1 | | |
| LAKWATCH | COL-JO-BAY3-1 | 2/20/09 | | | | | | | | | 340 | | | | 1.1 | | |
| LAKWATCH | COL-JO-BAY3-1 | 6/11/09 | | | | | | | | | 330 | | | | 1.9 | | |
| LAKWATCH | COL-JO-BAY3-1 | 9/14/09 | | | | | | | | | 350 | | | | 1.4 | | |
| LAKWATCH | COL-JO-BAY3-1 | 12/9/09 | | | | | | | | | 470 | | | | 1.6 | | |
| LAKWATCH | COL-JO-BAY3-1 | 3/23/10 | | | | | | | | | 340 | | | | 0.9 | | |
| LAKWATCH | COL-JO-BAY3-1 | 6/15/10 | | | | | | | | | 270 | | | | 2.0 | | |
| LAKWATCH | COL-JO-BAY3-1 | 9/23/10 | | | | | | | | | 330 | | | | 0.6 | | |
| LAKWATCH | COL-JO-BAY3-1 | 12/16/10 | | | | | | | | | 330 | | | | 0.6 | | |
| LAKWATCH | COL-JO-BAY3-1 | 3/31/11 | | | | | | | | | 310 | | | | 1.7 | | |
| LAKWATCH | COL-JO-BAY3-1 | 6/24/11 | | | | | | | | | 440 | | | | 1.6 | | |
| LAKWATCH | COL-JO-BAY3-1 | 9/14/11 | | | | | | | | | 320 | | | | 1.1 | | |
| LAKWATCH | COL-JO-BAY3-1 | 12/20/11 | | | | | | | | | 320 | | | | 1.1 | | |

Historical Water Quality Data for Waterbodies Adjacent to Marco Island

| Collecting Agency | Station ID | Sample Date | pH (s.u.) | Temp. (°C) | Diss. O ₂ (mg/L) | Cond. (µmho/cm) | Salinity (ppt) | Ammonia N (µg/L) | NOx (µg/L) | TKN (µg/L) | Total N (µg/L) | Total P (µg/L) | Chyl-a (mg/m ³) | Turbidity (NTU) | Secchi Depth (m) | Entero (cfu/100 mL) | TOC (mg/L) |
|-------------------|---------------|-------------|-----------|------------|-----------------------------|-----------------|----------------|------------------|------------|------------|----------------|----------------|-----------------------------|-----------------|------------------|---------------------|------------|
| LAKWATCH | COL-JO-BAY3-2 | 2/12/04 | | | | | | | | | 180 | | | | | | |
| LAKWATCH | COL-JO-BAY3-2 | 4/7/04 | | | | | | | | | 140 | | | | | | |
| LAKWATCH | COL-JO-BAY3-2 | 6/9/04 | | | | | | | | | 120 | | | | | | |
| LAKWATCH | COL-JO-BAY3-2 | 8/31/04 | | | | | | | | | 340 | | | | | | |
| LAKWATCH | COL-JO-BAY3-2 | 11/19/04 | | | | | | | | | 230 | | | | | | |
| LAKWATCH | COL-JO-BAY3-2 | 2/23/05 | | | | | | | | | 290 | | | | | | |
| LAKWATCH | COL-JO-BAY3-2 | 5/18/05 | | | | | | | | | 240 | | | | | | |
| LAKWATCH | COL-JO-BAY3-2 | 8/16/05 | | | | | | | | | 330 | | | | | | |
| LAKWATCH | COL-JO-BAY3-2 | 11/30/05 | | | | | | | | | 460 | | | | | | |
| LAKWATCH | COL-JO-BAY3-2 | 2/24/06 | | | | | | | | | 230 | | | | | | |
| LAKWATCH | COL-JO-BAY3-2 | 5/26/06 | | | | | | | | | 250 | | | | | | |
| LAKWATCH | COL-JO-BAY3-2 | 9/7/06 | | | | | | | | | 270 | | | | | | |
| LAKWATCH | COL-JO-BAY3-2 | 11/20/06 | | | | | | | | | 290 | | | | | | |
| LAKWATCH | COL-JO-BAY3-2 | 2/21/07 | | | | | | | | | 270 | | | | | | |
| LAKWATCH | COL-JO-BAY3-2 | 5/29/07 | | | | | | | | | 230 | | | | | | |
| LAKWATCH | COL-JO-BAY3-2 | 8/21/07 | | | | | | | | | 460 | | | | | | |
| LAKWATCH | COL-JO-BAY3-2 | 11/30/07 | | | | | | | | | 450 | | | | | | |
| LAKWATCH | COL-JO-BAY3-2 | 2/29/08 | | | | | | | | | 250 | | | | | | |
| LAKWATCH | COL-JO-BAY3-2 | 5/29/08 | | | | | | | | | 250 | | | | | | |
| LAKWATCH | COL-JO-BAY3-2 | 8/26/08 | | | | | | | | | 350 | | | | | | |
| LAKWATCH | COL-JO-BAY3-2 | 11/25/08 | | | | | | | | | 290 | | | | | | |
| LAKWATCH | COL-JO-BAY3-2 | 2/20/09 | | | | | | | | | 260 | | | | | | |
| LAKWATCH | COL-JO-BAY3-2 | 6/11/09 | | | | | | | | | 320 | | | | | | |
| LAKWATCH | COL-JO-BAY3-2 | 9/14/09 | | | | | | | | | 460 | | | | | | |
| LAKWATCH | COL-JO-BAY3-2 | 12/9/09 | | | | | | | | | 400 | | | | | | |
| LAKWATCH | COL-JO-BAY3-2 | 3/23/10 | | | | | | | | | 280 | | | | | | |
| LAKWATCH | COL-JO-BAY3-2 | 6/15/10 | | | | | | | | | 230 | | | | | | |
| LAKWATCH | COL-JO-BAY3-2 | 9/23/10 | | | | | | | | | 360 | | | | | | |
| LAKWATCH | COL-JO-BAY3-2 | 12/16/10 | | | | | | | | | 300 | | | | | | |
| LAKWATCH | COL-JO-BAY3-2 | 3/31/11 | | | | | | | | | 370 | | | | | | |
| LAKWATCH | COL-JO-BAY3-2 | 6/24/11 | | | | | | | | | 360 | | | | | | |
| LAKWATCH | COL-JO-BAY3-2 | 9/14/11 | | | | | | | | | 470 | | | | | | |
| LAKWATCH | COL-JO-BAY3-2 | 12/20/11 | | | | | | | | | 310 | | | | | | |

Historical Water Quality Data for Waterbodies Adjacent to Marco Island

| Collecting Agency | Station ID | Sample Date | pH (s.u.) | Temp. (°C) | Diss. O ₂ (mg/L) | Cond. (µmho/cm) | Salinity (ppt) | Ammonia N (µg/L) | NOx (µg/L) | TKN (µg/L) | Total N (µg/L) | Total P (µg/L) | Chyl-a (mg/m ³) | Turbidity (NTU) | Secchi Depth (m) | Entero (cfu/100 mL) | TOC (mg/L) |
|-------------------|---------------|-------------|-----------|------------|-----------------------------|-----------------|----------------|------------------|------------|------------|----------------|----------------|-----------------------------|-----------------|------------------|---------------------|------------|
| LAKEWATCH | COL-JO-BAY3-3 | 2/12/04 | | | | | | | | | 180 | | | | | | |
| LAKEWATCH | COL-JO-BAY3-3 | 4/7/04 | | | | | | | | | 130 | | | | | | |
| LAKEWATCH | COL-JO-BAY3-3 | 6/9/04 | | | | | | | | | 150 | | | | | | |
| LAKEWATCH | COL-JO-BAY3-3 | 8/31/04 | | | | | | | | | 360 | | | | | | |
| LAKEWATCH | COL-JO-BAY3-3 | 11/19/04 | | | | | | | | | 250 | | | | | | |
| LAKEWATCH | COL-JO-BAY3-3 | 2/23/05 | | | | | | | | | 290 | | | | | | |
| LAKEWATCH | COL-JO-BAY3-3 | 5/18/05 | | | | | | | | | 240 | | | | | | |
| LAKEWATCH | COL-JO-BAY3-3 | 8/16/05 | | | | | | | | | 340 | | | | | | |
| LAKEWATCH | COL-JO-BAY3-3 | 11/30/05 | | | | | | | | | 440 | | | | | | |
| LAKEWATCH | COL-JO-BAY3-3 | 2/24/06 | | | | | | | | | 260 | | | | | | |
| LAKEWATCH | COL-JO-BAY3-3 | 5/26/06 | | | | | | | | | 220 | | | | | | |
| LAKEWATCH | COL-JO-BAY3-3 | 9/7/06 | | | | | | | | | 240 | | | | | | |
| LAKEWATCH | COL-JO-BAY3-3 | 11/20/06 | | | | | | | | | 290 | | | | | | |
| LAKEWATCH | COL-JO-BAY3-3 | 2/21/07 | | | | | | | | | 250 | | | | | | |
| LAKEWATCH | COL-JO-BAY3-3 | 5/29/07 | | | | | | | | | 220 | | | | | | |
| LAKEWATCH | COL-JO-BAY3-3 | 8/21/07 | | | | | | | | | 370 | | | | | | |
| LAKEWATCH | COL-JO-BAY3-3 | 11/30/07 | | | | | | | | | 430 | | | | | | |
| LAKEWATCH | COL-JO-BAY3-3 | 2/29/08 | | | | | | | | | 240 | | | | | | |
| LAKEWATCH | COL-JO-BAY3-3 | 5/29/08 | | | | | | | | | 280 | | | | | | |
| LAKEWATCH | COL-JO-BAY3-3 | 8/26/08 | | | | | | | | | 340 | | | | | | |
| LAKEWATCH | COL-JO-BAY3-3 | 11/25/08 | | | | | | | | | 270 | | | | | | |
| LAKEWATCH | COL-JO-BAY3-3 | 2/20/09 | | | | | | | | | 370 | | | | | | |
| LAKEWATCH | COL-JO-BAY3-3 | 6/11/09 | | | | | | | | | 310 | | | | | | |
| LAKEWATCH | COL-JO-BAY3-3 | 9/14/09 | | | | | | | | | 400 | | | | | | |
| LAKEWATCH | COL-JO-BAY3-3 | 12/9/09 | | | | | | | | | 410 | | | | | | |
| LAKEWATCH | COL-JO-BAY3-3 | 3/23/10 | | | | | | | | | 240 | | | | | | |
| LAKEWATCH | COL-JO-BAY3-3 | 6/15/10 | | | | | | | | | 250 | | | | | | |
| LAKEWATCH | COL-JO-BAY3-3 | 9/23/10 | | | | | | | | | 400 | | | | | | |
| LAKEWATCH | COL-JO-BAY3-3 | 12/16/10 | | | | | | | | | 310 | | | | | | |
| LAKEWATCH | COL-JO-BAY3-3 | 3/31/11 | | | | | | | | | 380 | | | | | | |
| LAKEWATCH | COL-JO-BAY3-3 | 6/24/11 | | | | | | | | | 280 | | | | | | |
| LAKEWATCH | COL-JO-BAY3-3 | 9/14/11 | | | | | | | | | 510 | | | | | | |
| LAKEWATCH | COL-JO-BAY3-3 | 12/20/11 | | | | | | | | | 290 | | | | | | |

Historical Water Quality Data for Waterbodies Adjacent to Marco Island

| Collecting Agency | Station ID | Sample Date | pH (s.u.) | Temp. (°C) | Diss. O ₂ (mg/L) | Cond. (µmho/cm) | Salinity (ppt) | Ammonia N (µg/L) | NOx (µg/L) | TKN (µg/L) | Total N (µg/L) | Total P (µg/L) | Chyl-a (mg/m ³) | Turbidity (NTU) | Secchi Depth (m) | Entero (cfu/100 mL) | TOC (mg/L) |
|-------------------|-----------------|-------------|-----------|------------|-----------------------------|-----------------|----------------|------------------|------------|------------|----------------|----------------|-----------------------------|-----------------|------------------|---------------------|------------|
| LAKEWATCH | COL-PON BAY 1-1 | 4/25/01 | | | | | | | | | 420 | | | | 1.2 | | |
| LAKEWATCH | COL-PON BAY 1-1 | 6/25/01 | | | | | | | | | 390 | | | | 0.9 | | |
| LAKEWATCH | COL-PON BAY 1-1 | 8/24/01 | | | | | | | | | 320 | | | | 1.3 | | |
| LAKEWATCH | COL-PON BAY 1-1 | 3/20/02 | | | | | | | | | 410 | | | | 4.10 | | |
| LAKEWATCH | COL-PON BAY 1-1 | 7/29/02 | | | | | | | | | 500 | | | | 2.3 | | |
| LAKEWATCH | COL-PON BAY 1-1 | 4/2/03 | | | | | | | | | 310 | | | | | | |
| LAKEWATCH | COL-PON BAY 1-1 | 7/29/03 | | | | | | | | | 410 | | | | | | |
| LAKEWATCH | COL-PON BAY 1-1 | 10/9/03 | | | | | | | | | 400 | | | | | | |
| LAKEWATCH | COL-PON BAY 1-1 | 12/12/03 | | | | | | | | | 270 | | | | | | |
| LAKEWATCH | COL-PON BAY 1-1 | 12/22/03 | | | | | | | | | 230 | | | | | | |
| LAKEWATCH | COL-PON BAY 1-1 | 2/12/04 | | | | | | | | | 310 | | | | 1.6 | | |
| LAKEWATCH | COL-PON BAY 1-1 | 4/7/04 | | | | | | | | | 200 | | | | 1.3 | | |
| LAKEWATCH | COL-PON BAY 1-1 | 6/9/04 | | | | | | | | | 370 | | | | 1.4 | | |
| LAKEWATCH | COL-PON BAY 1-1 | 8/31/04 | | | | | | | | | 540 | | | | 1.4 | | |
| LAKEWATCH | COL-PON BAY 1-1 | 11/19/04 | | | | | | | | | 280 | | | | 2.80 | | |
| LAKEWATCH | COL-PON BAY 1-1 | 2/23/05 | | | | | | | | | 330 | | | | 1.9 | | |
| LAKEWATCH | COL-PON BAY 1-1 | 5/18/05 | | | | | | | | | 360 | | | | 1.4 | | |
| LAKEWATCH | COL-PON BAY 1-1 | 8/16/05 | | | | | | | | | 410 | | | | 1.6 | | |
| LAKEWATCH | COL-PON BAY 1-1 | 11/30/05 | | | | | | | | | 460 | | | | 1.6 | | |
| LAKEWATCH | COL-PON BAY 1-1 | 2/24/06 | | | | | | | | | 600 | | | | 1.7 | | |
| LAKEWATCH | COL-PON BAY 1-1 | 5/26/06 | | | | | | | | | 450 | | | | 1.4 | | |
| LAKEWATCH | COL-PON BAY 1-1 | 9/7/06 | | | | | | | | | 370 | | | | 1.2 | | |
| LAKEWATCH | COL-PON BAY 1-1 | 11/20/06 | | | | | | | | | 340 | | | | 1.1 | | |
| LAKEWATCH | COL-PON BAY 1-1 | 2/21/07 | | | | | | | | | 320 | | | | 1.6 | | |
| LAKEWATCH | COL-PON BAY 1-1 | 5/29/07 | | | | | | | | | 380 | | | | 1.6 | | |
| LAKEWATCH | COL-PON BAY 1-1 | 8/21/07 | | | | | | | | | 590 | | | | 1.4 | | |
| LAKEWATCH | COL-PON BAY 1-1 | 11/30/07 | | | | | | | | | 460 | | | | 1.2 | | |
| LAKEWATCH | COL-PON BAY 1-1 | 2/29/08 | | | | | | | | | 380 | | | | 1.2 | | |
| LAKEWATCH | COL-PON BAY 1-1 | 5/29/08 | | | | | | | | | 380 | | | | 1.5 | | |
| LAKEWATCH | COL-PON BAY 1-1 | 8/26/08 | | | | | | | | | 400 | | | | 1.4 | | |
| LAKEWATCH | COL-PON BAY 1-1 | 11/25/08 | | | | | | | | | 340 | | | | 2.2 | | |
| LAKEWATCH | COL-PON BAY 1-1 | 2/20/09 | | | | | | | | | 420 | | | | 1.1 | | |
| LAKEWATCH | COL-PON BAY 1-1 | 6/11/09 | | | | | | | | | 430 | | | | 1.0 | | |
| LAKEWATCH | COL-PON BAY 1-1 | 9/14/09 | | | | | | | | | 530 | | | | 1.4 | | |
| LAKEWATCH | COL-PON BAY 1-1 | 12/9/09 | | | | | | | | | 440 | | | | 1.7 | | |
| LAKEWATCH | COL-PON BAY 1-1 | 3/23/10 | | | | | | | | | 350 | | | | 1.4 | | |
| LAKEWATCH | COL-PON BAY 1-1 | 6/15/10 | | | | | | | | | 380 | | | | 1.2 | | |
| LAKEWATCH | COL-PON BAY 1-1 | 9/23/10 | | | | | | | | | 460 | | | | 0.8 | | |
| LAKEWATCH | COL-PON BAY 1-1 | 12/16/10 | | | | | | | | | 340 | | | | 1.1 | | |
| LAKEWATCH | COL-PON BAY 1-1 | 3/31/11 | | | | | | | | | 480 | | | | 0.9 | | |
| LAKEWATCH | COL-PON BAY 1-1 | 6/24/11 | | | | | | | | | 410 | | | | 1.1 | | |
| LAKEWATCH | COL-PON BAY 1-1 | 9/14/11 | | | | | | | | | 700 | | | | 0.9 | | |

Historical Water Quality Data for Waterbodies Adjacent to Marco Island

| Collecting Agency | Station ID | Sample Date | pH (s.u.) | Temp. (°C) | Diss. O ₂ (mg/L) | Cond. (µmho/cm) | Salinity (ppt) | Ammonia N (µg/L) | NOx (µg/L) | TKN (µg/L) | Total N (µg/L) | Total P (µg/L) | Chyl-a (mg/m ³) | Turbidity (NTU) | Secchi Depth (m) | Entero (cfu/100 mL) | TOC (mg/L) |
|-------------------|-----------------|-------------|-----------|------------|-----------------------------|-----------------|----------------|------------------|------------|------------|----------------|----------------|-----------------------------|-----------------|------------------|---------------------|------------|
| LAKEWATCH | COL-PON BAY 1-2 | 4/25/01 | | | | | | | | | 420 | | | | 1.2 | | |
| LAKEWATCH | COL-PON BAY 1-2 | 6/25/01 | | | | | | | | | 420 | | | | 1.3 | | |
| LAKEWATCH | COL-PON BAY 1-2 | 8/24/01 | | | | | | | | | 300 | | | | 2.3 | | |
| LAKEWATCH | COL-PON BAY 1-2 | 3/20/02 | | | | | | | | | 430 | | | | | | |
| LAKEWATCH | COL-PON BAY 1-2 | 7/29/02 | | | | | | | | | 530 | | | | | | |
| LAKEWATCH | COL-PON BAY 1-2 | 4/2/03 | | | | | | | | | 400 | | | | | | |
| LAKEWATCH | COL-PON BAY 1-2 | 7/29/03 | | | | | | | | | 380 | | | | | | |
| LAKEWATCH | COL-PON BAY 1-2 | 10/9/03 | | | | | | | | | 450 | | | | | | |
| LAKEWATCH | COL-PON BAY 1-2 | 12/12/03 | | | | | | | | | 250 | | | | | | |
| LAKEWATCH | COL-PON BAY 1-2 | 12/22/03 | | | | | | | | | 210 | | | | | | |
| LAKEWATCH | COL-PON BAY 1-2 | 2/12/04 | | | | | | | | | 370 | | | | | | |
| LAKEWATCH | COL-PON BAY 1-2 | 4/7/04 | | | | | | | | | 290 | | | | | | |
| LAKEWATCH | COL-PON BAY 1-2 | 6/9/04 | | | | | | | | | 230 | | | | | | |
| LAKEWATCH | COL-PON BAY 1-2 | 8/31/04 | | | | | | | | | 520 | | | | | | |
| LAKEWATCH | COL-PON BAY 1-2 | 11/19/04 | | | | | | | | | 290 | | | | | | |
| LAKEWATCH | COL-PON BAY 1-2 | 2/23/05 | | | | | | | | | 330 | | | | | | |
| LAKEWATCH | COL-PON BAY 1-2 | 5/18/05 | | | | | | | | | 330 | | | | | | |
| LAKEWATCH | COL-PON BAY 1-2 | 8/16/05 | | | | | | | | | 420 | | | | | | |
| LAKEWATCH | COL-PON BAY 1-2 | 11/30/05 | | | | | | | | | 450 | | | | | | |
| LAKEWATCH | COL-PON BAY 1-2 | 2/24/06 | | | | | | | | | 570 | | | | | | |
| LAKEWATCH | COL-PON BAY 1-2 | 5/26/06 | | | | | | | | | 420 | | | | | | |
| LAKEWATCH | COL-PON BAY 1-2 | 9/7/06 | | | | | | | | | 400 | | | | | | |
| LAKEWATCH | COL-PON BAY 1-2 | 11/20/06 | | | | | | | | | 340 | | | | | | |
| LAKEWATCH | COL-PON BAY 1-2 | 2/21/07 | | | | | | | | | 330 | | | | | | |
| LAKEWATCH | COL-PON BAY 1-2 | 5/29/07 | | | | | | | | | 430 | | | | | | |
| LAKEWATCH | COL-PON BAY 1-2 | 8/21/07 | | | | | | | | | 550 | | | | | | |
| LAKEWATCH | COL-PON BAY 1-2 | 11/30/07 | | | | | | | | | 480 | | | | | | |
| LAKEWATCH | COL-PON BAY 1-2 | 2/29/08 | | | | | | | | | 360 | | | | | | |
| LAKEWATCH | COL-PON BAY 1-2 | 5/29/08 | | | | | | | | | 380 | | | | | | |
| LAKEWATCH | COL-PON BAY 1-2 | 8/26/08 | | | | | | | | | 390 | | | | | | |
| LAKEWATCH | COL-PON BAY 1-2 | 11/25/08 | | | | | | | | | 410 | | | | | | |
| LAKEWATCH | COL-PON BAY 1-2 | 2/20/09 | | | | | | | | | 480 | | | | | | |
| LAKEWATCH | COL-PON BAY 1-2 | 6/11/09 | | | | | | | | | 410 | | | | | | |
| LAKEWATCH | COL-PON BAY 1-2 | 9/14/09 | | | | | | | | | 560 | | | | | | |
| LAKEWATCH | COL-PON BAY 1-2 | 12/9/09 | | | | | | | | | 450 | | | | | | |
| LAKEWATCH | COL-PON BAY 1-2 | 3/23/10 | | | | | | | | | 380 | | | | | | |
| LAKEWATCH | COL-PON BAY 1-2 | 6/15/10 | | | | | | | | | 480 | | | | | | |
| LAKEWATCH | COL-PON BAY 1-2 | 9/23/10 | | | | | | | | | 490 | | | | | | |
| LAKEWATCH | COL-PON BAY 1-2 | 12/16/10 | | | | | | | | | 340 | | | | | | |
| LAKEWATCH | COL-PON BAY 1-2 | 3/31/11 | | | | | | | | | 460 | | | | | | |
| LAKEWATCH | COL-PON BAY 1-2 | 6/24/11 | | | | | | | | | 340 | | | | | | |
| LAKEWATCH | COL-PON BAY 1-2 | 9/14/11 | | | | | | | | | 600 | | | | | | |

Historical Water Quality Data for Waterbodies Adjacent to Marco Island

| Collecting Agency | Station ID | Sample Date | pH (s.u.) | Temp. (°C) | Diss. O ₂ (mg/L) | Cond. (µmho/cm) | Salinity (ppt) | Ammonia N (µg/L) | NOx (µg/L) | TKN (µg/L) | Total N (µg/L) | Total P (µg/L) | Chyl-a (mg/m ³) | Turbidity (NTU) | Secchi Depth (m) | Entero (cfu/100 mL) | TOC (mg/L) |
|-------------------|-----------------|-------------|-----------|------------|-----------------------------|-----------------|----------------|------------------|------------|------------|----------------|----------------|-----------------------------|-----------------|------------------|---------------------|------------|
| LAKEWATCH | COL-PON BAY 1-3 | 4/25/01 | | | | | | | | | 420 | | | | 1.2 | | |
| LAKEWATCH | COL-PON BAY 1-3 | 6/25/01 | | | | | | | | | 390 | | | | | | |
| LAKEWATCH | COL-PON BAY 1-3 | 8/24/01 | | | | | | | | | 400 | | | | 1.3 | | |
| LAKEWATCH | COL-PON BAY 1-3 | 3/20/02 | | | | | | | | | 440 | | | | 2.3 | | |
| LAKEWATCH | COL-PON BAY 1-3 | 7/29/02 | | | | | | | | | 550 | | | | | | |
| LAKEWATCH | COL-PON BAY 1-3 | 4/2/03 | | | | | | | | | 420 | | | | | | |
| LAKEWATCH | COL-PON BAY 1-3 | 7/29/03 | | | | | | | | | 430 | | | | | | |
| LAKEWATCH | COL-PON BAY 1-3 | 10/9/03 | | | | | | | | | 520 | | | | | | |
| LAKEWATCH | COL-PON BAY 1-3 | 12/12/03 | | | | | | | | | 300 | | | | | | |
| LAKEWATCH | COL-PON BAY 1-3 | 12/22/03 | | | | | | | | | 240 | | | | | | |
| LAKEWATCH | COL-PON BAY 1-3 | 2/12/04 | | | | | | | | | 370 | | | | | | |
| LAKEWATCH | COL-PON BAY 1-3 | 4/7/04 | | | | | | | | | 180 | | | | | | |
| LAKEWATCH | COL-PON BAY 1-3 | 6/9/04 | | | | | | | | | 230 | | | | | | |
| LAKEWATCH | COL-PON BAY 1-3 | 8/31/04 | | | | | | | | | 520 | | | | | | |
| LAKEWATCH | COL-PON BAY 1-3 | 11/19/04 | | | | | | | | | 300 | | | | | | |
| LAKEWATCH | COL-PON BAY 1-3 | 2/23/05 | | | | | | | | | 330 | | | | | | |
| LAKEWATCH | COL-PON BAY 1-3 | 5/18/05 | | | | | | | | | 340 | | | | | | |
| LAKEWATCH | COL-PON BAY 1-3 | 8/16/05 | | | | | | | | | 410 | | | | | | |
| LAKEWATCH | COL-PON BAY 1-3 | 11/30/05 | | | | | | | | | 470 | | | | | | |
| LAKEWATCH | COL-PON BAY 1-3 | 2/24/06 | | | | | | | | | 700 | | | | | | |
| LAKEWATCH | COL-PON BAY 1-3 | 5/26/06 | | | | | | | | | 440 | | | | | | |
| LAKEWATCH | COL-PON BAY 1-3 | 9/7/06 | | | | | | | | | 410 | | | | | | |
| LAKEWATCH | COL-PON BAY 1-3 | 11/20/06 | | | | | | | | | 340 | | | | | | |
| LAKEWATCH | COL-PON BAY 1-3 | 2/21/07 | | | | | | | | | 320 | | | | | | |
| LAKEWATCH | COL-PON BAY 1-3 | 5/29/07 | | | | | | | | | 420 | | | | | | |
| LAKEWATCH | COL-PON BAY 1-3 | 8/21/07 | | | | | | | | | 520 | | | | | | |
| LAKEWATCH | COL-PON BAY 1-3 | 11/30/07 | | | | | | | | | 470 | | | | | | |
| LAKEWATCH | COL-PON BAY 1-3 | 2/29/08 | | | | | | | | | 360 | | | | | | |
| LAKEWATCH | COL-PON BAY 1-3 | 5/29/08 | | | | | | | | | 360 | | | | | | |
| LAKEWATCH | COL-PON BAY 1-3 | 8/26/08 | | | | | | | | | 320 | | | | | | |
| LAKEWATCH | COL-PON BAY 1-3 | 11/25/08 | | | | | | | | | 300 | | | | | | |
| LAKEWATCH | COL-PON BAY 1-3 | 2/20/09 | | | | | | | | | 580 | | | | | | |
| LAKEWATCH | COL-PON BAY 1-3 | 6/11/09 | | | | | | | | | 380 | | | | | | |
| LAKEWATCH | COL-PON BAY 1-3 | 9/14/09 | | | | | | | | | 530 | | | | | | |
| LAKEWATCH | COL-PON BAY 1-3 | 12/9/09 | | | | | | | | | 470 | | | | | | |
| LAKEWATCH | COL-PON BAY 1-3 | 3/23/10 | | | | | | | | | 380 | | | | | | |
| LAKEWATCH | COL-PON BAY 1-3 | 6/15/10 | | | | | | | | | 410 | | | | | | |
| LAKEWATCH | COL-PON BAY 1-3 | 9/23/10 | | | | | | | | | 530 | | | | | | |
| LAKEWATCH | COL-PON BAY 1-3 | 12/16/10 | | | | | | | | | 350 | | | | | | |
| LAKEWATCH | COL-PON BAY 1-3 | 3/31/11 | | | | | | | | | 520 | | | | | | |
| LAKEWATCH | COL-PON BAY 1-3 | 6/24/11 | | | | | | | | | 350 | | | | | | |
| LAKEWATCH | COL-PON BAY 1-3 | 9/14/11 | | | | | | | | | 640 | | | | | | |

Historical Water Quality Data for Waterbodies Adjacent to Marco Island

| Collecting Agency | Station ID | Sample Date | pH (s.u.) | Temp. (°C) | Diss. O ₂ (mg/L) | Cond. (µmho/cm) | Salinity (ppt) | Ammonia N (µg/L) | NOx (µg/L) | TKN (µg/L) | Total N (µg/L) | Total P (µg/L) | Chyl-a (mg/m ³) | Turbidity (NTU) | Secchi Depth (m) | Entero (cfu/100 mL) | TOC (mg/L) |
|-------------------|-----------------|-------------|-----------|------------|-----------------------------|-----------------|----------------|------------------|------------|------------|----------------|----------------|-----------------------------|-----------------|------------------|---------------------|------------|
| LAKWATCH | COL-PON BAY 2-1 | 2/12/04 | | | | | | | | | 190 | | | | 2.2 | | |
| LAKWATCH | COL-PON BAY 2-1 | 4/7/04 | | | | | | | | | 220 | | | | 1.2 | | |
| LAKWATCH | COL-PON BAY 2-1 | 6/9/04 | | | | | | | | | 200 | | | | 1.6 | | |
| LAKWATCH | COL-PON BAY 2-1 | 8/31/04 | | | | | | | | | 410 | | | | 1.6 | | |
| LAKWATCH | COL-PON BAY 2-1 | 11/19/04 | | | | | | | | | 250 | | | | 2.6 | | |
| LAKWATCH | COL-PON BAY 2-1 | 2/23/05 | | | | | | | | | 290 | | | | 1.1 | | |
| LAKWATCH | COL-PON BAY 2-1 | 5/18/05 | | | | | | | | | 320 | | | | 2.0 | | |
| LAKWATCH | COL-PON BAY 2-1 | 8/16/05 | | | | | | | | | 310 | | | | 1.4 | | |
| LAKWATCH | COL-PON BAY 2-1 | 11/30/05 | | | | | | | | | 430 | | | | 0.9 | | |
| LAKWATCH | COL-PON BAY 2-1 | 2/24/06 | | | | | | | | | 340 | | | | 1.4 | | |
| LAKWATCH | COL-PON BAY 2-1 | 5/26/06 | | | | | | | | | 230 | | | | 2.2 | | |
| LAKWATCH | COL-PON BAY 2-1 | 9/7/06 | | | | | | | | | 390 | | | | 1.4 | | |
| LAKWATCH | COL-PON BAY 2-1 | 11/20/06 | | | | | | | | | 310 | | | | 1.4 | | |
| LAKWATCH | COL-PON BAY 2-1 | 2/21/07 | | | | | | | | | 260 | | | | 1.1 | | |
| LAKWATCH | COL-PON BAY 2-1 | 5/29/07 | | | | | | | | | 230 | | | | 2.2 | | |
| LAKWATCH | COL-PON BAY 2-1 | 8/21/07 | | | | | | | | | 460 | | | | 1.7 | | |
| LAKWATCH | COL-PON BAY 2-1 | 11/30/07 | | | | | | | | | 430 | | | | 1.3 | | |
| LAKWATCH | COL-PON BAY 2-1 | 2/29/08 | | | | | | | | | 250 | | | | 1.2 | | |
| LAKWATCH | COL-PON BAY 2-1 | 5/29/08 | | | | | | | | | 290 | | | | 2.3 | | |
| LAKWATCH | COL-PON BAY 2-1 | 8/26/08 | | | | | | | | | 400 | | | | 1.2 | | |
| LAKWATCH | COL-PON BAY 2-1 | 11/25/08 | | | | | | | | | 250 | | | | 1.6 | | |
| LAKWATCH | COL-PON BAY 2-1 | 2/20/09 | | | | | | | | | 380 | | | | 0.8 | | |
| LAKWATCH | COL-PON BAY 2-1 | 6/11/09 | | | | | | | | | 340 | | | | 1.4 | | |
| LAKWATCH | COL-PON BAY 2-1 | 9/14/09 | | | | | | | | | 450 | | | | 1.2 | | |
| LAKWATCH | COL-PON BAY 2-1 | 12/9/09 | | | | | | | | | 430 | | | | 1.6 | | |
| LAKWATCH | COL-PON BAY 2-1 | 3/23/10 | | | | | | | | | 320 | | | | 0.9 | | |
| LAKWATCH | COL-PON BAY 2-1 | 6/15/10 | | | | | | | | | 260 | | | | 1.9 | | |
| LAKWATCH | COL-PON BAY 2-1 | 9/23/10 | | | | | | | | | 430 | | | | 0.9 | | |
| LAKWATCH | COL-PON BAY 2-1 | 12/16/10 | | | | | | | | | 350 | | | | 0.6 | | |
| LAKWATCH | COL-PON BAY 2-1 | 3/31/11 | | | | | | | | | 380 | | | | 0.5 | | |
| LAKWATCH | COL-PON BAY 2-1 | 6/24/11 | | | | | | | | | 370 | | | | 1.2 | | |
| LAKWATCH | COL-PON BAY 2-1 | 9/14/11 | | | | | | | | | 510 | | | | 0.9 | | |
| LAKWATCH | COL-PON BAY 2-1 | 12/20/11 | | | | | | | | | 290 | | | | 1.4 | | |

Historical Water Quality Data for Waterbodies Adjacent to Marco Island

| Collecting Agency | Station ID | Sample Date | pH (s.u.) | Temp. (°C) | Diss. O ₂ (mg/L) | Cond. (µmho/cm) | Salinity (ppt) | Ammonia N (µg/L) | NOx (µg/L) | TKN (µg/L) | Total N (µg/L) | Total P (µg/L) | Chyl-a (mg/m ³) | Turbidity (NTU) | Secchi Depth (m) | Entero (cfu/100 mL) | TOC (mg/L) |
|-------------------|-----------------|-------------|-----------|------------|-----------------------------|-----------------|----------------|------------------|------------|------------|----------------|----------------|-----------------------------|-----------------|------------------|---------------------|------------|
| LAKWATCH | COL-PON BAY 2-2 | 2/12/04 | | | | | | | | | 140 | | | | | | |
| LAKWATCH | COL-PON BAY 2-2 | 4/7/04 | | | | | | | | | 190 | | | | | | |
| LAKWATCH | COL-PON BAY 2-2 | 6/9/04 | | | | | | | | | 270 | | | | | | |
| LAKWATCH | COL-PON BAY 2-2 | 8/31/04 | | | | | | | | | 440 | | | | | | |
| LAKWATCH | COL-PON BAY 2-2 | 11/19/04 | | | | | | | | | 210 | | | | | | |
| LAKWATCH | COL-PON BAY 2-2 | 2/23/05 | | | | | | | | | 300 | | | | | | |
| LAKWATCH | COL-PON BAY 2-2 | 5/18/05 | | | | | | | | | 290 | | | | | | |
| LAKWATCH | COL-PON BAY 2-2 | 8/16/05 | | | | | | | | | 330 | | | | | | |
| LAKWATCH | COL-PON BAY 2-2 | 11/30/05 | | | | | | | | | 390 | | | | | | |
| LAKWATCH | COL-PON BAY 2-2 | 2/24/06 | | | | | | | | | 340 | | | | | | |
| LAKWATCH | COL-PON BAY 2-2 | 5/26/06 | | | | | | | | | 220 | | | | | | |
| LAKWATCH | COL-PON BAY 2-2 | 9/7/06 | | | | | | | | | 420 | | | | | | |
| LAKWATCH | COL-PON BAY 2-2 | 11/20/06 | | | | | | | | | 280 | | | | | | |
| LAKWATCH | COL-PON BAY 2-2 | 2/21/07 | | | | | | | | | 270 | | | | | | |
| LAKWATCH | COL-PON BAY 2-2 | 5/29/07 | | | | | | | | | 280 | | | | | | |
| LAKWATCH | COL-PON BAY 2-2 | 8/21/07 | | | | | | | | | 460 | | | | | | |
| LAKWATCH | COL-PON BAY 2-2 | 11/30/07 | | | | | | | | | 440 | | | | | | |
| LAKWATCH | COL-PON BAY 2-2 | 2/29/08 | | | | | | | | | 250 | | | | | | |
| LAKWATCH | COL-PON BAY 2-2 | 5/29/08 | | | | | | | | | 290 | | | | | | |
| LAKWATCH | COL-PON BAY 2-2 | 8/26/08 | | | | | | | | | 300 | | | | | | |
| LAKWATCH | COL-PON BAY 2-2 | 11/25/08 | | | | | | | | | 280 | | | | | | |
| LAKWATCH | COL-PON BAY 2-2 | 2/20/09 | | | | | | | | | 370 | | | | | | |
| LAKWATCH | COL-PON BAY 2-2 | 6/11/09 | | | | | | | | | 360 | | | | | | |
| LAKWATCH | COL-PON BAY 2-2 | 9/14/09 | | | | | | | | | 450 | | | | | | |
| LAKWATCH | COL-PON BAY 2-2 | 12/9/09 | | | | | | | | | 430 | | | | | | |
| LAKWATCH | COL-PON BAY 2-2 | 3/23/10 | | | | | | | | | 350 | | | | | | |
| LAKWATCH | COL-PON BAY 2-2 | 6/15/10 | | | | | | | | | 270 | | | | | | |
| LAKWATCH | COL-PON BAY 2-2 | 9/23/10 | | | | | | | | | 400 | | | | | | |
| LAKWATCH | COL-PON BAY 2-2 | 12/16/10 | | | | | | | | | 420 | | | | | | |
| LAKWATCH | COL-PON BAY 2-2 | 3/31/11 | | | | | | | | | 350 | | | | | | |
| LAKWATCH | COL-PON BAY 2-2 | 6/24/11 | | | | | | | | | 330 | | | | | | |
| LAKWATCH | COL-PON BAY 2-2 | 9/14/11 | | | | | | | | | 470 | | | | | | |
| LAKWATCH | COL-PON BAY 2-2 | 12/20/11 | | | | | | | | | 240 | | | | | | |

Historical Water Quality Data for Waterbodies Adjacent to Marco Island

| Collecting Agency | Station ID | Sample Date | pH (s.u.) | Temp. (°C) | Diss. O ₂ (mg/L) | Cond. (µmho/cm) | Salinity (ppt) | Ammonia N (µg/L) | NOx (µg/L) | TKN (µg/L) | Total N (µg/L) | Total P (µg/L) | Chyl-a (mg/m ³) | Turbidity (NTU) | Secchi Depth (m) | Entero (cfu/100 mL) | TOC (mg/L) |
|-------------------|-----------------|-------------|-----------|------------|-----------------------------|-----------------|----------------|------------------|------------|------------|----------------|----------------|-----------------------------|-----------------|------------------|---------------------|------------|
| LAKWATCH | COL-PON BAY 2-3 | 2/12/04 | | | | | | | | | 190 | | | | | | |
| LAKWATCH | COL-PON BAY 2-3 | 4/7/04 | | | | | | | | | 100 | | | | | | |
| LAKWATCH | COL-PON BAY 2-3 | 6/9/04 | | | | | | | | | 270 | | | | | | |
| LAKWATCH | COL-PON BAY 2-3 | 8/31/04 | | | | | | | | | 440 | | | | | | |
| LAKWATCH | COL-PON BAY 2-3 | 11/19/04 | | | | | | | | | 230 | | | | | | |
| LAKWATCH | COL-PON BAY 2-3 | 2/23/05 | | | | | | | | | 430 | | | | | | |
| LAKWATCH | COL-PON BAY 2-3 | 5/18/05 | | | | | | | | | 300 | | | | | | |
| LAKWATCH | COL-PON BAY 2-3 | 8/16/05 | | | | | | | | | 330 | | | | | | |
| LAKWATCH | COL-PON BAY 2-3 | 11/30/05 | | | | | | | | | 440 | | | | | | |
| LAKWATCH | COL-PON BAY 2-3 | 2/24/06 | | | | | | | | | 340 | | | | | | |
| LAKWATCH | COL-PON BAY 2-3 | 5/26/06 | | | | | | | | | 200 | | | | | | |
| LAKWATCH | COL-PON BAY 2-3 | 9/7/06 | | | | | | | | | 350 | | | | | | |
| LAKWATCH | COL-PON BAY 2-3 | 11/20/06 | | | | | | | | | 290 | | | | | | |
| LAKWATCH | COL-PON BAY 2-3 | 2/21/07 | | | | | | | | | 250 | | | | | | |
| LAKWATCH | COL-PON BAY 2-3 | 5/29/07 | | | | | | | | | 230 | | | | | | |
| LAKWATCH | COL-PON BAY 2-3 | 8/21/07 | | | | | | | | | 380 | | | | | | |
| LAKWATCH | COL-PON BAY 2-3 | 11/30/07 | | | | | | | | | 440 | | | | | | |
| LAKWATCH | COL-PON BAY 2-3 | 2/29/08 | | | | | | | | | 260 | | | | | | |
| LAKWATCH | COL-PON BAY 2-3 | 5/29/08 | | | | | | | | | 340 | | | | | | |
| LAKWATCH | COL-PON BAY 2-3 | 8/26/08 | | | | | | | | | 350 | | | | | | |
| LAKWATCH | COL-PON BAY 2-3 | 11/25/08 | | | | | | | | | 260 | | | | | | |
| LAKWATCH | COL-PON BAY 2-3 | 2/20/09 | | | | | | | | | 370 | | | | | | |
| LAKWATCH | COL-PON BAY 2-3 | 6/11/09 | | | | | | | | | 370 | | | | | | |
| LAKWATCH | COL-PON BAY 2-3 | 9/14/09 | | | | | | | | | 450 | | | | | | |
| LAKWATCH | COL-PON BAY 2-3 | 12/9/09 | | | | | | | | | 430 | | | | | | |
| LAKWATCH | COL-PON BAY 2-3 | 3/23/10 | | | | | | | | | 320 | | | | | | |
| LAKWATCH | COL-PON BAY 2-3 | 6/15/10 | | | | | | | | | 250 | | | | | | |
| LAKWATCH | COL-PON BAY 2-3 | 9/23/10 | | | | | | | | | 420 | | | | | | |
| LAKWATCH | COL-PON BAY 2-3 | 12/16/10 | | | | | | | | | 380 | | | | | | |
| LAKWATCH | COL-PON BAY 2-3 | 3/31/11 | | | | | | | | | 390 | | | | | | |
| LAKWATCH | COL-PON BAY 2-3 | 6/24/11 | | | | | | | | | 330 | | | | | | |
| LAKWATCH | COL-PON BAY 2-3 | 9/14/11 | | | | | | | | | 420 | | | | | | |
| LAKWATCH | COL-PON BAY 2-3 | 12/20/11 | | | | | | | | | 270 | | | | | | |
| | | | | | | | | | | | | | | | | | |
| FDEP, South Dist. | EVRGWC0031FTM | 1/17/06 | 7.75 | 18.70 | 10.2 | 50.582 | | 45 | 12 | 840 | 862 | | | 29.0 | 0.5 | | |
| FDEP, South Dist. | EVRGWC0031FTM | 6/14/06 | 7.85 | 27.68 | 6.5 | 55.306 | | 110 | 14 | 1200 | 1214 | | | 24.0 | 1.0 | | |
| FDEP, South Dist. | EVRGWC0031FTM | 8/9/06 | 7.73 | 28.61 | 7.4 | 48.246 | | | | 800 | 800 | | | 11.9 | 0.8 | | |
| FDEP, South Dist. | EVRGWC0031FTM | 2/22/10 | 7.86 | 17.35 | 8.5 | 52.782 | | | | | | | | | | | |
| FDEP, South Dist. | EVRGWC0031FTM | 4/5/10 | 7.92 | 22.70 | 8.0 | 49.746 | | | | | | | | | | | |
| FDEP, South Dist. | EVRGWC0031FTM | 7/7/10 | 7.94 | 28.19 | 4.9 | 50.496 | | | | | | | | | 1.3 | | |
| FDEP, South Dist. | EVRGWC0031FTM | 10/6/10 | 7.87 | 25.53 | 1.1 | 50.910 | | | | | | | | | 0.9 | | |
| | | | | | | | | | | | | | | | | | |
| FDEP, South Dist. | EVRGWC0032FTM | 1/17/06 | 7.76 | 18.42 | 10.5 | 50.570 | | 47 | 11 | 680 | 681 | | | 5.6 | 1.3 | | |
| FDEP, South Dist. | EVRGWC0032FTM | 6/12/06 | 7.77 | 28.31 | 5.0 | 54.961 | | 140 | 12 | 850 | 862 | | | 5.0 | 1.1 | | |
| FDEP, South Dist. | EVRGWC0032FTM | 10/4/06 | 7.98 | 28.38 | 6.9 | 44.998 | | | | | | | | 3.5 | 3.5 | | |
| | | | | | | | | | | | | | | | | | |
| FDEP, South Dist. | EVRGWC0033FTM | 1/17/06 | 7.80 | 18.30 | 10.1 | 50.616 | | 29 | 10 | 740 | 750 | | | 17.7 | 0.8 | | |
| FDEP, South Dist. | EVRGWC0033FTM | 6/12/06 | 7.83 | 28.00 | 5.0 | 55.080 | | 110 | | 790 | 790 | | | 1.0 | 1.0 | | |
| FDEP, South Dist. | EVRGWC0033FTM | 10/4/06 | 7.97 | 28.19 | 6.2 | 45.847 | | | | | | | | 3.2 | 3.5 | | |
| | | | | | | | | | | | | | | | | | |
| FDEP, South Dist. | EVRGWC0034FTM | 1/17/06 | 7.76 | 18.24 | 10.1 | 50.085 | | 54 | 16 | 720 | 736 | | | 0.7 | 1.4 | | |
| FDEP, South Dist. | EVRGWC0034FTM | 10/4/06 | 7.92 | 28.38 | 5.7 | 42.744 | | | | 260 | 260 | | | 0.2 | 4.5 | | |
| | | | | | | | | | | | | | | | | | |
| FDEP, South Dist. | EVRGWC0035FTM | 1/17/06 | 7.69 | 19.08 | 9.4 | 49.593 | | 90 | 41 | 770 | 811 | | | 1.9 | | | |
| FDEP, South Dist. | EVRGWC0035FTM | 6/12/06 | 7.72 | 28.90 | 2.9 | 54.804 | | 160 | 14 | 1000 | 1014 | | | 2.4 | 1.3 | | |
| FDEP, South Dist. | EVRGWC0035FTM | 10/4/06 | 7.84 | 28.51 | 5.5 | 40.283 | | | | 640 | 640 | 23 | | 3.0 | 2.5 | | |
| | | | | | | | | | | | | | | | | | |
| FDEP, South Dist. | EVRGWC0036FTM | 1/17/06 | 7.78 | 19.05 | 7.9 | 50.227 | | | | 680 | 680 | | | 1.1 | | | |
| FDEP, South Dist. | EVRGWC0036FTM | 6/12/06 | 7.77 | 29.42 | 4.2 | 54.425 | | 110 | 31 | 430 | 430 | | | 3.2 | 2.5 | | |
| FDEP, South Dist. | EVRGWC0036FTM | 10/4/06 | 7.73 | 29.24 | 3.1 | 44.235 | | 23 | | | 28 | | | | 5.5 | | |

Historical Water Quality Data for Waterbodies Adjacent to Marco Island

| Collecting Agency | Station ID | Sample Date | pH (s.u.) | Temp. (°C) | Diss. O ₂ (mg/L) | Cond. (µmho/cm) | Salinity (ppt) | Ammonia N (µg/L) | NOx (µg/L) | TKN (µg/L) | Total N (µg/L) | Total P (µg/L) | Chyl-a (mg/m ³) | Turbidity (NTU) | Secchi Depth (m) | Entero (cfu/100 mL) | TOC (mg/L) |
|-------------------|---------------|-------------|-----------|------------|-----------------------------|-----------------|----------------|------------------|------------|------------|----------------|----------------|-----------------------------|-----------------|------------------|---------------------|------------|
| FDEP, South Dist. | EVRCWC0037FTM | 1/17/06 | 7.86 | 18.49 | 8.6 | 50.338 | | | | | | | | 2.3 | | | |
| FDEP, South Dist. | EVRCWC0037FTM | 6/12/06 | 7.91 | 28.46 | 5.6 | 54.388 | 120 | 14 | 14 | 1100 | 1114 | | | 5.2 | 1.0 | | |
| FDEP, South Dist. | EVRCWC0037FTM | 10/4/06 | 7.94 | 28.54 | 6.1 | 46.032 | | | | | | | | 3.1 | 3.5 | | |
| FDEP, South Dist. | EVRCWC0090FTM | 2/22/10 | 7.89 | 17.50 | 8.5 | 52.840 | | | | | | | | | | | |
| FDEP, South Dist. | EVRCWC0090FTM | 4/5/10 | 7.80 | 23.96 | 7.3 | 48.097 | | | | | | | | | | | |
| FDEP, South Dist. | EVRCWC0090FTM | 7/7/10 | 8.00 | 29.03 | 6.0 | 49.663 | | | | | 484 | | | | | | |
| FDEP, South Dist. | EVRCWC0090FTM | 10/6/10 | 7.90 | 25.84 | 1.9 | 51.091 | | | | | 597 | | | | 0.8 | | |
| FDEP | G1SD0001 | 9/8/14 | | 30.26 | 5.3 | 50.790 | | | | 400 | | | | | | | |
| FDEP | G1SD0001 | 12/11/14 | | 18.62 | 6.9 | 51.160 | | 22 | | | | | | | | | |
| FDEP | G1SD0001 | 3/19/15 | | 25.83 | 6.2 | 51.690 | | 10 | | | | | | | | | |
| FDEP | G1SD0001 | 6/3/15 | | 28.70 | 5.7 | 52.690 | | | | | | | | | | | |
| FDEP | G1SD0001 | 9/2/15 | 7.85 | 29.71 | 4.5 | 47.234 | | 14 | | 480 | | | | | | | |
| FDEP | G1SD0001 | 11/17/15 | 7.89 | 25.20 | 6.1 | 51.318 | | 37 | | 560 | | | | | | | |
| FDEP | G1SD0001 | 2/16/16 | 8.05 | 18.62 | 7.5 | 49.980 | | | | | | | | | | | |
| FDEP | G1SD0001 | 4/26/16 | 7.99 | 26.30 | 5.8 | 51.958 | | 11 | | | | | | | | | |
| FDEP | G1SD0001 | 8/30/16 | 7.89 | 29.43 | 4.9 | 50.717 | | | | | | | | | | | |
| FDEP | G1SD0001 | 11/16/16 | 7.85 | 22.53 | 7.85 | 53.498 | | 16 | | | | | | | | | |
| FDEP | G1SD0001 | 2/23/17 | 7.96 | 22.71 | 5.2 | 52.183 | | 12 | | 410 | 422 | | | | | | |
| FDEP | G1SD0001 | 5/31/17 | 8.01 | 30.71 | 5.6 | 56.089 | | 13 | | 410 | 423 | | | | | | |
| FDEP | G1SD0001 | 9/26/17 | 7.86 | 30.00 | 7.00 | 47.100 | | 19 | | 420 | 439 | 38 | 6.5 | | | | |
| FDEP | G1SD0001 | 11/29/17 | 7.60 | 23.30 | 5.1 | 51.300 | | 12 | | 300 | 312 | 29 | 1.5 | | | | |
| FDEP | G1SD0001 | 2/21/18 | 7.94 | 24.60 | 5.2 | 52.700 | | 14 | | 310 | 324 | 38 | 1.9 | | | | |
| FDEP | G1SD0001 | 5/1/18 | 8.01 | 25.80 | 6.1 | 54.500 | | 11 | | 440 | 451 | 38 | 1.3 | | | | |
| FDEP | G1SD0001 | 8/28/18 | 7.85 | 29.25 | 4.8 | 49.241 | | 18 | | 450 | 468 | 47 | 2.6 | | | | |
| FDEP | G1SD0001 | 12/13/18 | 7.84 | 19.10 | 5.2 | 52.640 | | 18 | | 510 | 528 | 79 | 2.9 | | | | |
| FDEP | G1SD0001 | 2/28/19 | 7.82 | 24.86 | 5.1 | 51.740 | | 18 | | 290 | 308 | 38 | 2.1 | | | | |
| FDEP | G1SD0001 | 5/1/19 | 7.91 | 25.83 | 5.2 | 52.146 | | 6 | | 290 | 296 | 26 | 1.5 | | | | |
| FDEP | G1SD0001 | 9/24/19 | 8.06 | 27.42 | 5.2 | 52.546 | | 4 | | 290 | 294 | 22 | 1.8 | 0.9 | | | |
| FDEP | G1SD0001 | 11/20/19 | 7.96 | 22.10 | 5.2 | 52.120 | | 17 | | 420 | 437 | 37 | 6.5 | 3.4 | | | |
| FDEP | G1SD0001 | 2/18/20 | 7.93 | 24.00 | 5.1 | 51.476 | | 10 | | 410 | 420 | 32 | 1.2 | 4.2 | | | |
| FDEP | G1SD0001 | 9/16/20 | 7.80 | 29.12 | 4.5 | 45.478 | | 41 | | 380 | 421 | 49 | 3.8 | 9.7 | | | |
| FDEP | G1SD0003 | 9/8/14 | | 30.46 | 5.9 | 51.440 | | | | | | | | | | | |
| FDEP | G1SD0003 | 12/11/14 | | 18.57 | 6.8 | 51.360 | | | | | | | | | | | |
| FDEP | G1SD0003 | 3/19/15 | | 25.64 | 6.4 | 50.210 | | | | | | | | | | | |
| FDEP | G1SD0003 | 6/3/15 | | 28.45 | 5.7 | 52.690 | | | | 1900 | 1900 | | | | | | |
| FDEP | G1SD0003 | 9/2/15 | 8.01 | 30.06 | 5.8 | 50.252 | | | | | | | | | | | |
| FDEP | G1SD0003 | 11/17/15 | 7.88 | 25.90 | 5.8 | 51.692 | | 13 | | | | | | | | | |
| FDEP | G1SD0003 | 2/16/16 | 8.04 | 18.09 | 7.5 | 49.610 | | | | | | | | | | | |
| FDEP | G1SD0003 | 4/26/16 | 7.94 | 26.49 | 6.5 | 51.916 | | | | | | | | | | | |
| FDEP | G1SD0003 | 8/30/16 | 8.06 | 29.25 | 5.3 | 49.834 | | | | 440 | 440 | | | | | | |
| FDEP | G1SD0003 | 11/16/16 | 7.99 | 22.86 | 7.99 | 53.453 | | | | 430 | 430 | | | | | | |
| FDEP | G1SD0003 | 2/23/17 | 8.01 | 22.50 | 5.2 | 52.248 | | | | | | | | | | | |
| FDEP | G1SD0003 | 5/31/17 | 8.01 | 30.73 | 5.6 | 56.389 | | | | | | | | | | | |
| FDEP | G1SD0003 | 11/29/17 | 7.88 | 23.40 | 5.1 | 51.400 | | | | | | | | | | | |
| FDEP | G1SD0003 | 2/21/18 | 7.94 | 24.50 | 5.2 | 52.600 | | | | 300 | 304 | 33 | 2.7 | | | | |
| FDEP | G1SD0003 | 5/1/18 | 7.37 | 26.60 | 5.4 | 50.400 | | 4 | | 390 | 394 | 45 | 5.3 | | | | |
| FDEP | G1SD0003 | 8/28/18 | 7.90 | 29.41 | 5.0 | 50.576 | | 4 | | 400 | 404 | 39 | 1.8 | | | | |
| FDEP | G1SD0003 | 12/13/18 | 7.86 | 19.38 | 5.2 | 52.670 | | 10 | | 320 | 330 | 36 | 2.8 | | | | |
| FDEP | G1SD0003 | 2/28/19 | 7.86 | 24.97 | 5.1 | 51.660 | | 4 | | 490 | 494 | 47 | 6.0 | | | | |
| FDEP | G1SD0003 | 5/1/19 | 7.92 | 26.46 | 5.2 | 52.660 | | 4 | | 290 | 294 | 35 | 2.3 | | | | |
| FDEP | G1SD0003 | 9/24/19 | 8.08 | 27.41 | 5.2 | 52.253 | | 4 | | 340 | 344 | 23 | 1.7 | 1.2 | | | |
| FDEP | G1SD0003 | 11/20/19 | 7.99 | 22.30 | 4.30 | 51.860 | | 4 | | 430 | 434 | 35 | 7.1 | 4.2 | | | |
| FDEP | G1SD0003 | 2/18/20 | 7.98 | 23.79 | 5.1 | 51.468 | | 4 | | 410 | 414 | 31 | 1.7 | 7.2 | | | |
| FDEP | G1SD0003 | 9/16/20 | 7.87 | 29.01 | 4.7 | 47.707 | | 19 | | 470 | 489 | 52 | 7.3 | 14.0 | | | |
| FDEP | G1SD0003 | 11/18/20 | 7.97 | 24.81 | 4.8 | 48.411 | | 15 | | 400 | 415 | 32 | 3.4 | 3.7 | | | |

Historical Water Quality Data for Waterbodies Adjacent to Marco Island

| Collecting Agency | Station ID | Sample Date | pH (s.u.) | Temp. (°C) | Diss. O ₂ (mg/L) | Cond. (µmho/cm) | Salinity (ppt) | Ammonia N (µg/L) | NOx (µg/L) | TKN (µg/L) | Total N (µg/L) | Total P (µg/L) | Chyl-a (mg/m ³) | Turbidity (NTU) | Secchi Depth (m) | Enterococci (cfu/100 mL) | TOC (mg/L) |
|-------------------|------------|-------------|-----------|------------|-----------------------------|-----------------|----------------|------------------|------------|------------|----------------|----------------|-----------------------------|-----------------|------------------|--------------------------|------------|
| FDEP | G1SD0006 | 9/27/17 | 7.39 | 30.70 | | 35.100 | | | 4 | 770 | 774 | 100 | 17.0 | | | | |
| FDEP | G1SD0006 | 11/28/17 | 7.79 | 23.60 | | 50.600 | | | 4 | 510 | 514 | 60 | 7.4 | | | | |
| FDEP | G1SD0006 | 11/28/17 | | | | | | | | 530 | 534 | 59 | 7.2 | | | | |
| FDEP | G1SD0006 | 2/22/18 | 7.81 | 25.40 | | 51.900 | | | 7 | 470 | 477 | 65 | 6.6 | | | | |
| FDEP | G1SD0006 | 5/2/18 | 7.83 | 25.40 | | 56.100 | | | 4 | 480 | 484 | 29 | 5.1 | | | | |
| FDEP | G1SD0006 | 5/2/18 | 7.83 | 25.40 | | 56.100 | | | 4 | 460 | 464 | 28 | 4.6 | | | | |
| FDEP | G1SD0006 | 8/29/18 | 7.72 | 28.90 | | 44.671 | | | 12 | 620 | 632 | 73 | 5.3 | | | | |
| FDEP | G1SD0006 | 8/29/18 | | | | | | | 12 | 600 | 612 | 73 | 5.0 | | | | |
| FDEP | G1SD0006 | 12/13/18 | 7.78 | 18.86 | | 53.240 | | | 14 | 390 | 404 | 54 | 2.4 | | | | |
| FDEP | G1SD0006 | 12/13/18 | 7.78 | 18.86 | | 53.240 | | | 14 | 370 | 384 | 50 | 2.1 | | | | |
| FDEP | G1SD0006 | 2/27/19 | 7.83 | 25.90 | | 50.914 | | | 20 | 470 | 480 | 44 | 2.4 | | | | |
| FDEP | G1SD0006 | 2/27/19 | 7.83 | 25.90 | | 50.914 | | | 22 | 490 | 512 | 39 | 0.9 | | | | |
| FDEP | G1SD0006 | 4/30/19 | 7.53 | 27.44 | | 53.580 | | | 9 | 510 | 519 | 50 | 2.7 | | | | |
| FDEP | G1SD0006 | 4/30/19 | 7.53 | 27.44 | | 53.580 | | | 9 | 510 | 519 | 52 | 2.6 | | | | |
| FDEP | G1SD0006 | 9/24/19 | 8.05 | 27.88 | | 50.052 | | | 4 | 420 | 424 | 39 | 5.3 | 6.3 | | | |
| FDEP | G1SD0006 | 9/24/19 | 8.05 | 27.88 | | 50.052 | | | 4 | 410 | 414 | 40 | 6.9 | 6.7 | | | |
| FDEP | G1SD0006 | 11/20/19 | 7.83 | 22.20 | | 52.000 | | | 4 | 460 | 464 | 42 | 5.1 | 5.0 | | | |
| FDEP | G1SD0006 | 11/20/19 | | | | | | | 4 | 510 | 514 | 42 | 4.5 | 5.4 | | | |
| FDEP | G1SD0006 | 2/18/20 | 7.99 | 23.91 | | 51.172 | | | 12 | 520 | 532 | 46 | 2.0 | 7.1 | | | |
| FDEP | G1SD0006 | 2/18/20 | | | | | | | 10 | 490 | 500 | 47 | 1.8 | 7.2 | | | |
| FDEP | G1SD0006 | 9/16/20 | 7.67 | 28.76 | | 34.249 | | | 31 | 630 | 661 | 54 | 5.3 | 10.0 | | | |
| FDEP | G1SD0006 | 9/16/20 | | | | | | | 30 | 630 | 660 | 55 | 5.5 | 11.0 | | | |
| FDEP | G1SD0006 | 11/18/20 | 7.81 | 23.73 | | 47.672 | | | 9 | 400 | 409 | 43 | 5.7 | 12.0 | | | |

A-6: Characteristics of Reuse Irrigation Produced by Marco Island

Characteristics of Marco Island Reuse Irrigation from 2012 - 2020

| Date | Reuse | | | | | |
|----------|-----------|----------|----------|----------|---------|----------|
| | Flow - MG | PO4 mg/L | NO3 mg/L | TKN mg/L | Total N | TSS mg/L |
| 1/4/12 | 1.69 | 4.74 | 6.44 | 0.97 | 7.41 | 0.6 |
| 1/11/12 | 1.54 | 5.00 | 9.04 | 1.25 | 10.29 | 0.6 |
| 1/18/12 | 1.81 | 4.49 | 14.10 | 1.36 | 15.46 | 0.6 |
| 1/25/12 | 1.98 | 4.97 | 8.20 | 1.13 | 9.33 | 0.6 |
| 2/1/12 | 1.66 | 4.55 | 5.84 | 1.06 | 6.90 | 0.6 |
| 2/8/12 | 2.04 | 4.95 | 7.78 | 1.14 | 8.92 | 0.6 |
| 2/15/12 | 2.16 | 4.25 | 7.25 | 1.17 | 8.42 | 0.6 |
| 2/22/12 | 2.14 | 4.21 | 5.43 | 1.35 | 6.78 | 0.6 |
| 2/29/12 | 1.39 | 4.22 | 5.04 | 1.29 | 6.33 | 0.6 |
| 3/7/12 | 2.40 | 5.08 | 6.93 | 1.37 | 8.30 | 0.6 |
| 3/14/12 | 2.31 | 4.53 | 6.51 | 1.12 | 7.63 | 0.6 |
| 3/21/12 | 2.24 | 4.04 | 5.42 | 1.03 | 6.45 | 0.6 |
| 3/28/12 | 2.37 | 4.53 | 5.83 | 1.01 | 6.84 | 0.6 |
| 4/4/12 | 2.56 | 4.16 | 6.40 | 1.32 | 7.72 | 0.6 |
| 4/11/12 | 2.30 | 5.05 | 5.65 | 1.06 | 6.71 | 0.6 |
| 4/18/12 | 2.10 | 3.94 | 6.39 | 1.12 | 7.51 | 0.6 |
| 4/25/12 | 1.64 | 5.31 | 10.70 | 1.30 | 12.00 | 0.6 |
| 5/2/12 | 1.40 | 4.20 | 7.04 | 1.11 | 8.15 | 0.6 |
| 5/9/12 | 1.93 | 3.12 | 7.25 | 0.99 | 8.24 | 0.7 |
| 5/16/12 | 2.05 | 3.87 | 10.50 | 0.66 | 11.16 | 0.6 |
| 5/23/12 | 1.90 | 2.60 | 7.71 | 0.96 | 8.67 | 0.9 |
| 5/30/12 | 1.88 | 2.41 | 4.68 | 1.02 | 5.70 | 0.6 |
| 6/6/12 | 1.86 | 2.31 | 8.92 | 1.47 | 10.39 | 0.6 |
| 6/13/12 | 1.83 | 2.73 | 8.79 | 1.05 | 9.84 | 0.6 |
| 6/20/12 | 1.77 | 2.63 | 8.08 | 1.22 | 9.30 | 0.6 |
| 6/27/12 | 1.41 | 3.02 | 13.50 | 0.77 | 14.27 | 0.6 |
| 7/4/12 | 2.23 | 2.66 | 10.70 | 0.93 | 11.63 | 0.6 |
| 7/11/12 | 1.94 | 3.04 | 10.50 | 0.93 | 11.43 | 0.6 |
| 7/18/12 | 1.90 | 3.87 | 17.80 | 0.93 | 18.73 | 0.8 |
| 7/25/12 | 1.54 | 3.11 | 13.40 | 1.15 | 14.55 | 0.6 |
| 8/1/12 | 2.42 | 2.46 | 9.22 | 1.04 | 10.26 | 0.6 |
| 8/8/12 | 2.02 | 2.82 | 12.60 | 1.30 | 13.90 | 0.6 |
| 8/15/12 | 1.50 | 3.64 | 19.20 | 1.54 | 20.74 | 0.6 |
| 8/22/12 | 0.91 | 3.34 | 16.80 | 1.28 | 18.08 | 0.6 |
| 8/29/12 | 1.32 | 2.21 | 14.10 | 1.18 | 15.28 | 0.6 |
| 9/5/12 | 1.10 | 2.69 | 11.50 | 0.78 | 12.28 | 0.6 |
| 9/12/12 | 1.06 | 2.30 | 15.60 | 0.44 | 16.04 | 0.6 |
| 9/19/12 | 1.08 | 2.40 | 15.80 | 0.57 | 16.37 | 0.6 |
| 9/26/12 | 1.23 | 2.80 | 13.70 | 0.45 | 14.15 | 0.6 |
| 10/3/12 | 0.84 | 2.40 | 12.80 | 0.70 | 13.50 | 0.6 |
| 10/10/12 | 1.14 | 2.30 | 10.60 | 0.97 | 11.57 | 0.6 |
| 10/17/12 | 1.38 | 2.80 | 11.60 | 0.88 | 12.48 | 0.6 |
| 10/24/12 | 1.60 | 2.91 | 12.00 | 0.80 | 12.80 | 0.6 |
| 10/31/12 | 1.78 | 3.39 | 11.00 | 0.76 | 11.76 | 0.6 |
| 11/7/12 | 2.58 | 3.02 | 10.30 | 1.00 | 11.30 | 1.2 |
| 11/14/12 | 2.30 | 3.12 | 7.39 | 0.99 | 8.38 | 0.6 |
| 11/21/12 | 2.14 | 1.23 | 7.27 | 1.23 | 8.50 | 0.6 |
| 11/28/12 | 2.51 | 2.59 | 4.11 | 0.98 | 5.09 | 0.6 |
| 12/5/12 | 2.28 | 3.27 | 5.14 | 0.92 | 6.06 | 0.6 |
| 12/12/12 | 1.20 | 3.60 | 5.61 | 1.14 | 6.75 | 0.6 |

Characteristics of Marco Island Reuse Irrigation from 2012 - 2020

| Date | Reuse | | | | | |
|----------|-----------|----------|----------|----------|---------|----------|
| | Flow - MG | PO4 mg/L | NO3 mg/L | TKN mg/L | Total N | TSS mg/L |
| 12/19/12 | 1.67 | 3.77 | 4.76 | 1.05 | 5.81 | 0.6 |
| 12/26/12 | 1.76 | 3.69 | 4.07 | 0.95 | 5.02 | 0.6 |
| 1/2/13 | 2.32 | 4.32 | 6.82 | 0.98 | 7.80 | 0.6 |
| 1/9/13 | 1.81 | 5.18 | 9.54 | 1.11 | 10.65 | 0.6 |
| 1/16/13 | 1.76 | 4.65 | 11.30 | 1.11 | 12.41 | 0.6 |
| 1/23/13 | 1.84 | 4.23 | 8.65 | 1.02 | 9.67 | 0.6 |
| 1/30/13 | 2.31 | 4.15 | 6.15 | 1.06 | 7.21 | 0.6 |
| 2/6/13 | 2.21 | 3.95 | 5.15 | 1.43 | 6.58 | 0.6 |
| 2/13/13 | 2.28 | 4.22 | 5.74 | 1.03 | 6.77 | 0.6 |
| 2/20/13 | 1.61 | 3.75 | 8.14 | 1.16 | 9.30 | 0.6 |
| 2/27/13 | 2.24 | 4.83 | 6.85 | 1.05 | 7.90 | 0.6 |
| 3/6/13 | 2.42 | 4.25 | 7.23 | 1.29 | 8.52 | 0.6 |
| 3/13/13 | 2.71 | 4.32 | 6.15 | 1.08 | 7.23 | 0.6 |
| 3/20/13 | 1.61 | 4.66 | 7.22 | 1.24 | 8.46 | 0.6 |
| 3/27/13 | 2.66 | 4.32 | 7.47 | 0.98 | 8.45 | 0.6 |
| 4/3/13 | 2.54 | 3.53 | 5.20 | 0.84 | 6.04 | 0.6 |
| 4/10/13 | 1.87 | 4.12 | 5.33 | 0.94 | 6.27 | 0.6 |
| 4/17/13 | 2.22 | 4.76 | 5.99 | 0.98 | 6.97 | 0.6 |
| 4/24/13 | 1.51 | 4.31 | 5.77 | 1.06 | 6.83 | 0.6 |
| 5/1/13 | 1.93 | 2.73 | 4.06 | 0.87 | 4.93 | 0.6 |
| 5/8/13 | 2.46 | 3.19 | 5.27 | 0.94 | 6.21 | 0.6 |
| 5/15/13 | 2.17 | 2.30 | 4.22 | 0.89 | 5.11 | 0.6 |
| 5/22/13 | 2.29 | 2.32 | 4.79 | 0.87 | 5.66 | 0.6 |
| 5/29/13 | 1.76 | 3.18 | 4.79 | 0.78 | 5.57 | 0.6 |
| 6/5/13 | 0.57 | 2.60 | 11.10 | 0.80 | 11.90 | 0.6 |
| 6/12/13 | 0.96 | 2.76 | 8.91 | 0.93 | 9.84 | 0.6 |
| 6/19/13 | 1.22 | 3.64 | 16.00 | 1.22 | 17.22 | 0.6 |
| 6/26/13 | 0.58 | 2.45 | 5.69 | 0.98 | 6.67 | 0.6 |
| 7/3/13 | 1.02 | 1.35 | 2.28 | 0.99 | 3.27 | 0.6 |
| 7/10/13 | 0.81 | 2.74 | 5.42 | 1.18 | 6.60 | 0.6 |
| 7/17/13 | 1.07 | 2.64 | 8.03 | 1.13 | 9.16 | 0.6 |
| 7/24/13 | 1.64 | 3.84 | 9.69 | 0.95 | 10.64 | 0.6 |
| 7/31/13 | 1.16 | 3.62 | 8.17 | 0.95 | 9.12 | 0.6 |
| 8/7/13 | 1.40 | 3.34 | 7.40 | 0.97 | 8.37 | 0.6 |
| 8/14/13 | 1.54 | 3.53 | 5.90 | 0.79 | 6.69 | 0.6 |
| 8/21/13 | 0.81 | 3.28 | 9.13 | 0.84 | 9.97 | 0.6 |
| 8/28/13 | 0.70 | 2.63 | 6.45 | 0.98 | 7.43 | 0.6 |
| 9/4/13 | 1.28 | 3.22 | 5.71 | 0.89 | 6.60 | 0.6 |
| 9/11/13 | 0.61 | 2.36 | 8.45 | 1.00 | 9.45 | 0.6 |
| 9/18/13 | 1.11 | 3.08 | 9.22 | 1.07 | 10.29 | 0.6 |
| 9/25/13 | 0.58 | 3.40 | 9.28 | 1.00 | 10.28 | 0.6 |
| 10/2/13 | 0.54 | 3.03 | 9.98 | 1.11 | 11.09 | 0.6 |
| 10/9/13 | 1.26 | 3.16 | 8.60 | 1.05 | 9.65 | 0.6 |
| 10/16/13 | 2.53 | 3.04 | 6.23 | 0.94 | 7.17 | 0.6 |
| 10/23/13 | 2.01 | 4.16 | 8.92 | 1.15 | 10.07 | 0.6 |
| 10/30/13 | 2.35 | 2.24 | 3.24 | 1.33 | 4.57 | 0.6 |
| 11/6/13 | 2.44 | 2.45 | 5.06 | 1.03 | 6.09 | 0.6 |
| 11/13/13 | 2.41 | 2.58 | 4.01 | 0.85 | 4.86 | 0.6 |
| 11/20/13 | 2.27 | 3.61 | 7.87 | 0.96 | 8.83 | 0.6 |
| 11/27/13 | 1.92 | 4.41 | 8.84 | 1.16 | 10.00 | 0.6 |

Characteristics of Marco Island Reuse Irrigation from 2012 - 2020

| Date | Reuse | | | | | |
|----------|-----------|----------|----------|----------|---------|----------|
| | Flow - MG | PO4 mg/L | NO3 mg/L | TKN mg/L | Total N | TSS mg/L |
| 12/4/13 | 1.84 | 4.57 | 6.10 | 1.13 | 7.23 | 0.6 |
| 12/11/13 | 2.27 | 3.15 | 6.18 | 0.92 | 7.10 | 0.6 |
| 12/18/13 | 2.01 | 4.15 | 10.40 | 0.88 | 11.28 | 0.6 |
| 12/23/13 | 2.30 | 3.76 | 8.92 | 0.81 | 9.73 | 0.6 |
| 12/30/13 | 1.69 | 4.03 | 5.66 | 0.92 | 6.58 | 0.6 |
| 1/8/14 | 1.50 | 6.16 | 18.80 | 1.03 | 19.83 | 0.6 |
| 1/15/14 | 2.30 | 4.53 | 6.25 | 1.20 | 7.45 | 0.6 |
| 1/22/14 | 2.31 | 4.53 | 6.86 | 1.11 | 7.97 | 0.6 |
| 1/29/14 | 1.68 | 4.76 | 9.72 | 1.16 | 10.88 | 0.6 |
| 2/5/14 | 1.61 | 4.00 | 8.56 | 1.29 | 9.85 | 0.6 |
| 2/12/14 | 1.37 | 4.31 | 7.45 | 1.15 | 8.60 | 0.6 |
| 2/19/14 | 2.73 | 5.93 | 11.30 | 1.19 | 12.49 | 0.6 |
| 2/26/14 | 2.26 | 4.02 | 6.62 | 1.09 | 7.71 | 0.6 |
| 3/5/14 | 2.43 | 4.00 | 6.23 | 1.04 | 7.27 | 0.6 |
| 3/12/14 | 1.29 | 4.00 | 6.23 | 1.27 | 7.50 | 0.6 |
| 3/19/14 | 1.17 | 6.06 | 8.95 | 1.04 | 9.99 | 0.6 |
| 3/26/14 | 1.73 | 3.71 | 6.86 | 1.00 | 7.86 | 0.6 |
| 4/2/14 | 2.24 | 3.76 | 7.10 | 1.00 | 8.10 | 0.6 |
| 4/9/14 | 2.06 | 4.34 | 7.10 | 0.87 | 7.97 | 0.6 |
| 4/16/14 | 2.42 | 6.66 | 11.80 | 1.24 | 13.04 | 0.6 |
| 4/23/14 | 2.21 | 4.16 | 5.65 | 1.03 | 6.68 | 0.6 |
| 4/30/14 | 1.95 | 4.20 | 5.65 | 0.74 | 6.39 | 0.6 |
| 5/7/14 | 1.77 | 3.31 | 3.45 | 0.98 | 4.43 | 0.6 |
| 5/14/14 | 1.89 | 4.80 | 5.53 | 0.58 | 6.11 | 0.6 |
| 5/21/14 | 2.24 | 2.40 | 2.75 | 0.53 | 3.28 | 0.6 |
| 5/28/14 | 1.93 | 3.20 | 3.66 | 5.70 | 9.36 | 0.6 |
| 6/4/14 | 1.44 | 3.61 | 13.60 | 0.86 | 14.46 | 0.6 |
| 6/11/14 | 2.32 | 2.47 | 11.90 | 0.80 | 12.70 | 0.6 |
| 6/18/14 | 1.47 | 3.72 | 12.80 | 0.80 | 13.60 | 0.6 |
| 6/25/14 | 1.78 | 3.41 | 8.75 | 0.71 | 9.46 | 0.6 |
| 7/2/14 | 1.84 | 2.57 | 7.06 | 0.74 | 7.80 | 0.6 |
| 7/9/14 | 1.39 | 3.07 | 7.11 | 0.51 | 7.62 | 0.6 |
| 7/16/14 | 1.44 | 3.13 | 8.16 | 0.43 | 8.59 | 0.6 |
| 7/23/14 | 2.00 | 3.53 | 8.54 | 0.68 | 9.22 | 0.6 |
| 7/30/14 | 1.91 | 3.18 | 9.70 | 0.50 | 10.20 | 0.6 |
| 8/6/14 | 1.03 | 1.89 | 7.64 | 0.52 | 8.16 | 0.6 |
| 8/13/14 | 1.25 | 2.74 | 8.85 | 0.65 | 9.50 | 0.6 |
| 8/20/14 | 1.35 | 3.98 | 9.79 | 1.22 | 11.01 | 0.6 |
| 8/27/14 | 1.62 | 5.03 | 18.80 | 0.87 | 19.67 | 0.6 |
| 9/3/14 | 0.82 | 2.26 | 6.92 | 0.75 | 7.67 | 0.6 |
| 9/10/14 | 1.48 | 2.65 | 9.54 | 0.78 | 10.32 | 0.6 |
| 9/17/14 | 1.39 | 2.61 | 11.60 | 0.74 | 12.34 | 0.6 |
| 9/24/14 | 0.92 | 2.56 | 13.20 | 0.59 | 13.79 | 0.6 |
| 10/1/14 | 0.75 | 2.98 | 13.60 | 1.02 | 14.62 | 0.7 |
| 10/8/14 | 1.67 | 2.88 | 12.70 | 0.81 | 13.51 | 0.6 |
| 10/15/14 | 1.52 | 3.28 | 9.87 | 0.83 | 10.70 | 0.7 |
| 10/22/14 | 1.82 | 3.28 | 10.30 | 0.87 | 11.17 | 0.6 |
| 10/29/14 | 1.80 | 3.57 | 11.20 | 0.78 | 11.98 | 0.6 |
| 11/5/14 | 2.16 | 3.52 | 11.40 | 0.80 | 12.20 | 0.6 |
| 11/12/14 | 2.21 | 4.96 | 17.30 | 0.78 | 18.08 | 0.6 |

Characteristics of Marco Island Reuse Irrigation from 2012 - 2020

| Date | Reuse | | | | | |
|----------|-----------|----------|----------|----------|---------|----------|
| | Flow - MG | PO4 mg/L | NO3 mg/L | TKN mg/L | Total N | TSS mg/L |
| 11/19/14 | 1.95 | 3.12 | 11.00 | 0.92 | 11.92 | 0.6 |
| 11/26/14 | 1.65 | 3.67 | 13.50 | 0.93 | 14.43 | 0.6 |
| 12/3/14 | 1.90 | 3.75 | 12.10 | 0.64 | 12.74 | 0.6 |
| 12/10/14 | 1.84 | 3.84 | 12.20 | 0.86 | 13.06 | 0.6 |
| 12/17/14 | 1.99 | 3.41 | 7.93 | 0.68 | 8.61 | 0.6 |
| 12/24/14 | 2.20 | 3.63 | 9.33 | 1.03 | 10.36 | 0.6 |
| 12/31/14 | 2.68 | 3.68 | 7.05 | 1.20 | 8.25 | 0.6 |
| 1/7/15 | 2.59 | 4.55 | 7.23 | 0.85 | 8.08 | 0.6 |
| 1/14/15 | 2.29 | 2.53 | 9.23 | 0.91 | 10.14 | 0.6 |
| 1/21/15 | 2.51 | 2.38 | 9.83 | 0.97 | 10.80 | 0.6 |
| 1/28/15 | 2.38 | 3.50 | 6.37 | 1.32 | 7.69 | 0.6 |
| 2/4/15 | 2.49 | 4.34 | 7.19 | 0.99 | 8.18 | 0.6 |
| 2/11/15 | 2.31 | 4.61 | 6.64 | 0.70 | 7.34 | 0.6 |
| 2/18/15 | 2.61 | 4.13 | 7.96 | 1.10 | 9.06 | 0.6 |
| 2/25/15 | 2.32 | 3.96 | 6.91 | 1.41 | 8.32 | 0.6 |
| 3/4/15 | 1.38 | 3.87 | 7.73 | 0.83 | 8.56 | 0.6 |
| 3/11/15 | 2.91 | 4.09 | 7.78 | 1.06 | 8.84 | 0.6 |
| 3/18/15 | 2.80 | 3.04 | 6.86 | 1.08 | 7.94 | 0.6 |
| 3/25/15 | 3.04 | 5.92 | 7.94 | 0.99 | 8.93 | 0.6 |
| 4/1/15 | 2.77 | 4.65 | 8.42 | 1.15 | 9.57 | 0.6 |
| 4/8/15 | 2.85 | 3.95 | 3.33 | 0.84 | 4.17 | 0.6 |
| 4/15/15 | 2.35 | 7.16 | 6.95 | 0.95 | 7.90 | 0.6 |
| 4/22/15 | 2.32 | 5.25 | 6.97 | 1.01 | 7.98 | 0.6 |
| 4/29/15 | 2.38 | 5.60 | 8.33 | 0.86 | 9.19 | 0.6 |
| 5/6/15 | 1.97 | 3.59 | 8.76 | 0.69 | 9.45 | 0.6 |
| 5/13/15 | 1.66 | 4.08 | 11.60 | 1.13 | 12.73 | 0.6 |
| 5/20/15 | 1.92 | 2.80 | 10.20 | 1.22 | 11.42 | 0.6 |
| 5/27/15 | 1.60 | 3.43 | 8.30 | 0.94 | 9.24 | 0.6 |
| 6/3/15 | 1.90 | 5.03 | 10.30 | 1.08 | 11.38 | 0.6 |
| 6/10/15 | 2.27 | 2.48 | 7.13 | 0.69 | 7.82 | 0.6 |
| 6/17/15 | 2.15 | 2.09 | 7.62 | 1.16 | 8.78 | 0.6 |
| 6/24/15 | 2.24 | 2.53 | 0.01 | 0.70 | 0.71 | 0.6 |
| 7/1/15 | 2.49 | 2.57 | 6.67 | 1.04 | 7.71 | 0.6 |
| 7/8/15 | 1.77 | 3.10 | 4.73 | 0.80 | 5.53 | 0.6 |
| 7/15/15 | 1.78 | 3.22 | 9.46 | 1.22 | 10.68 | 0.6 |
| 7/22/15 | 1.77 | 3.14 | 10.10 | 0.96 | 11.06 | 0.6 |
| 7/29/15 | 1.25 | 4.04 | 11.60 | 0.87 | 12.47 | 0.6 |
| 8/5/15 | 1.93 | 2.96 | 7.87 | 0.92 | 8.79 | 0.6 |
| 8/12/15 | 2.03 | 3.08 | 5.08 | 6.76 | 11.84 | 0.6 |
| 8/19/15 | 2.16 | 3.01 | 9.16 | 0.71 | 9.87 | 0.6 |
| 8/26/15 | 1.48 | 2.86 | 0.01 | 0.55 | 0.56 | 0.6 |
| 9/2/15 | 1.19 | 1.99 | 5.51 | 0.86 | 6.37 | 0.6 |
| 9/9/15 | 0.92 | 2.32 | 4.36 | 0.92 | 5.28 | 1.4 |
| 9/16/15 | 1.98 | 2.93 | 6.78 | 0.80 | 7.58 | 0.6 |
| 9/23/15 | 0.84 | 2.57 | 5.71 | 0.99 | 6.70 | 0.6 |
| 9/30/15 | 0.88 | 2.20 | 8.28 | 0.47 | 8.75 | 0.6 |
| 10/7/15 | 1.25 | 2.79 | 7.43 | 0.85 | 8.28 | 0.6 |
| 10/14/15 | 1.89 | 2.41 | 10.10 | 1.15 | 11.25 | 0.6 |
| 10/21/15 | 1.76 | 2.91 | 2.75 | 1.35 | 4.10 | 0.6 |
| 10/28/15 | 1.62 | 2.87 | 7.40 | 0.56 | 7.96 | 0.6 |

Characteristics of Marco Island Reuse Irrigation from 2012 - 2020

| Date | Reuse | | | | | |
|----------|-----------|----------|----------|----------|---------|----------|
| | Flow - MG | PO4 mg/L | NO3 mg/L | TKN mg/L | Total N | TSS mg/L |
| 11/4/15 | 1.79 | 3.03 | 9.22 | 0.54 | 9.76 | 0.6 |
| 11/11/15 | 1.27 | 3.02 | 5.05 | 0.79 | 5.84 | 0.6 |
| 11/18/15 | 1.88 | 3.66 | 8.45 | 1.39 | 9.84 | 0.6 |
| 11/25/15 | 1.39 | 3.00 | 10.20 | 1.33 | 11.53 | 0.6 |
| 12/2/15 | 1.72 | 3.99 | 8.98 | 1.13 | 10.11 | 0.6 |
| 12/9/15 | 0.95 | 3.61 | 12.40 | 1.52 | 13.92 | 0.6 |
| 12/16/15 | 1.34 | 4.26 | 9.69 | 1.06 | 10.75 | 0.6 |
| 12/23/15 | 1.65 | 3.53 | 6.90 | 1.40 | 8.30 | 0.6 |
| 12/30/15 | 2.06 | 4.14 | 6.82 | 1.05 | 7.87 | 0.6 |
| 1/6/16 | 2.21 | 4.84 | 7.20 | 1.17 | 8.37 | 0.6 |
| 1/13/16 | 1.06 | 4.62 | 6.92 | 0.99 | 7.91 | 0.6 |
| 1/20/16 | 1.02 | 4.21 | 7.89 | 1.13 | 9.02 | 0.6 |
| 1/27/16 | 0.80 | 3.54 | 7.68 | 1.27 | 8.95 | 0.6 |
| 2/3/16 | 1.03 | 5.26 | 11.00 | 1.20 | 12.20 | 0.6 |
| 2/10/16 | 1.16 | 3.57 | 6.57 | 1.24 | 7.81 | 0.6 |
| 2/17/16 | 1.25 | 4.38 | 6.51 | 1.06 | 7.57 | 0.6 |
| 2/24/16 | 1.39 | 3.96 | 6.51 | 1.13 | 7.64 | 0.6 |
| 3/2/16 | 2.31 | 6.42 | 6.18 | 1.07 | 7.25 | 0.6 |
| 3/9/16 | 2.61 | 3.86 | 6.24 | 1.62 | 7.86 | 0.6 |
| 3/16/16 | 2.68 | 5.32 | 5.24 | 1.86 | 7.10 | 0.6 |
| 3/23/16 | 2.59 | 4.00 | 7.17 | 0.92 | 8.09 | 0.6 |
| 3/30/16 | 1.91 | 3.85 | 4.97 | 1.35 | 6.32 | 0.6 |
| 4/6/16 | 2.58 | 3.80 | 5.80 | 1.10 | 6.90 | 0.6 |
| 4/13/16 | 2.27 | 4.39 | 4.96 | 1.05 | 6.01 | 0.6 |
| 4/20/16 | 2.19 | 4.72 | 9.36 | 1.45 | 10.81 | 0.6 |
| 4/27/16 | 1.95 | 4.68 | 8.85 | 1.20 | 10.05 | 0.6 |
| 5/4/16 | 1.96 | 3.33 | 8.89 | 1.05 | 9.94 | 0.6 |
| 5/11/16 | 1.96 | 3.00 | 5.87 | 0.97 | 6.84 | 0.6 |
| 5/18/16 | 2.08 | 2.51 | 4.75 | 1.23 | 5.98 | 0.6 |
| 5/25/16 | 2.28 | 2.88 | 8.19 | 1.06 | 9.25 | 0.6 |
| 6/1/16 | 1.73 | 3.38 | 8.00 | 1.26 | 9.26 | 0.6 |
| 6/8/16 | 1.02 | 5.00 | 9.34 | 1.03 | 10.37 | 0.6 |
| 6/15/16 | 1.96 | 3.37 | 8.25 | 0.91 | 9.16 | 0.6 |
| 6/22/16 | 2.30 | 2.84 | 7.09 | 0.97 | 8.06 | 0.6 |
| 6/29/16 | 1.87 | 3.55 | 10.10 | 1.09 | 11.19 | 0.6 |
| 7/6/16 | 1.91 | 4.34 | 6.04 | 0.53 | 6.57 | 0.6 |
| 7/13/16 | 1.70 | 4.24 | 7.22 | 0.99 | 8.21 | 0.6 |
| 7/20/16 | 1.23 | 3.32 | 11.10 | 1.14 | 12.24 | 0.6 |
| 7/27/16 | 1.51 | 3.15 | 12.20 | 0.94 | 13.14 | 0.6 |
| 8/3/16 | 1.34 | 3.39 | 16.40 | 1.18 | 17.58 | 0.6 |
| 8/10/16 | 1.08 | 4.32 | 19.50 | 1.28 | 20.78 | 0.6 |
| 8/17/16 | 1.20 | 3.13 | 11.00 | 0.88 | 11.88 | 0.6 |
| 8/24/16 | 1.44 | 3.48 | 10.20 | 1.00 | 11.20 | 0.6 |
| 8/31/16 | 1.01 | 2.41 | 11.40 | 0.79 | 12.19 | 0.6 |
| 9/7/16 | 0.94 | 2.16 | 10.10 | 0.96 | 11.06 | 0.6 |
| 9/14/16 | 0.79 | 2.17 | 12.10 | 0.89 | 12.99 | 0.6 |
| 9/21/16 | 1.65 | 2.97 | 9.93 | 0.84 | 10.77 | 0.6 |
| 9/28/16 | 1.58 | 2.91 | 10.40 | 1.07 | 11.47 | 0.6 |
| 10/5/16 | 1.42 | 2.31 | 9.45 | 0.94 | 10.39 | 0.6 |
| 10/12/16 | 1.71 | 3.58 | 13.40 | 1.02 | 14.42 | 0.6 |

Characteristics of Marco Island Reuse Irrigation from 2012 - 2020

| Date | Reuse | | | | | |
|----------|-----------|----------|----------|----------|---------|----------|
| | Flow - MG | PO4 mg/L | NO3 mg/L | TKN mg/L | Total N | TSS mg/L |
| 10/19/16 | 1.96 | 3.22 | 8.94 | 1.07 | 10.01 | 0.6 |
| 10/26/16 | 2.08 | 3.52 | 11.50 | 0.99 | 12.49 | 0.6 |
| 11/2/16 | 2.38 | 2.84 | 11.70 | 0.99 | 12.69 | 0.6 |
| 11/9/16 | 2.38 | 3.63 | 2.41 | 1.13 | 3.54 | 0.6 |
| 11/16/16 | 2.10 | 3.50 | 6.89 | 1.02 | 7.91 | 0.6 |
| 11/23/16 | 2.62 | 2.99 | 8.18 | 1.04 | 9.22 | 0.6 |
| 11/30/16 | 2.07 | 2.99 | 7.60 | 1.03 | 8.63 | 0.6 |
| 12/7/16 | 2.23 | 3.42 | 4.99 | 0.87 | 5.86 | 0.6 |
| 12/14/16 | 2.44 | 3.09 | 4.18 | 0.71 | 4.89 | 0.6 |
| 12/21/16 | 2.20 | 3.85 | 7.43 | 1.19 | 8.62 | 0.6 |
| 12/28/16 | 2.89 | 4.29 | 12.20 | 1.06 | 13.26 | 0.6 |
| 1/4/17 | 2.26 | 5.34 | 10.40 | 1.10 | 11.50 | 0.6 |
| 1/11/17 | 2.36 | 4.53 | 11.90 | 1.08 | 12.98 | 0.6 |
| 1/18/17 | 2.31 | 4.64 | 10.20 | 2.00 | 12.20 | 0.6 |
| 1/25/17 | 2.34 | 4.37 | 10.00 | 0.88 | 10.88 | 0.6 |
| 2/1/17 | 2.29 | 4.93 | 11.70 | 1.01 | 12.71 | 0.6 |
| 2/8/17 | 2.54 | 4.11 | 7.20 | 0.96 | 8.16 | 0.6 |
| 2/15/17 | 2.60 | 4.37 | 6.37 | 0.85 | 7.22 | 0.6 |
| 2/22/17 | 1.32 | 4.48 | 6.19 | 0.87 | 7.06 | 0.6 |
| 3/1/17 | 2.56 | 4.28 | 6.57 | 0.93 | 7.50 | 0.6 |
| 3/8/17 | 2.98 | 5.50 | 10.20 | 0.96 | 11.16 | 0.6 |
| 3/15/17 | 2.69 | 4.45 | 5.97 | 0.82 | 6.79 | 0.6 |
| 3/22/17 | 2.92 | 4.38 | 6.95 | 0.87 | 7.82 | 0.6 |
| 3/29/17 | 2.48 | 4.41 | 7.23 | 0.59 | 7.82 | 0.6 |
| 4/5/17 | 2.74 | 4.71 | 7.21 | 0.94 | 8.15 | 0.6 |
| 4/12/17 | 2.73 | 5.31 | 6.41 | 0.84 | 7.25 | 0.6 |
| 4/19/17 | 2.31 | 4.96 | 7.27 | 0.74 | 8.01 | 0.6 |
| 4/26/17 | 2.34 | 4.19 | 6.50 | 0.68 | 7.18 | 0.6 |
| 5/3/17 | 2.53 | 3.91 | 5.22 | 0.64 | 5.86 | 0.6 |
| 5/10/17 | 2.69 | 3.58 | 6.21 | 0.49 | 6.70 | 0.6 |
| 5/17/17 | 2.22 | 5.18 | 13.30 | 0.67 | 13.97 | 0.6 |
| 5/24/17 | 2.30 | 3.97 | 6.95 | 0.63 | 7.58 | 0.6 |
| 5/31/17 | 2.36 | 2.81 | 7.35 | 0.74 | 8.09 | 0.6 |
| 6/7/17 | 0.82 | 2.02 | 6.98 | 0.57 | 7.55 | 0.6 |
| 6/14/17 | 0.93 | 2.96 | 17.70 | 0.67 | 18.37 | 0.6 |
| 6/21/17 | 1.07 | 5.11 | 25.60 | 0.88 | 26.48 | 0.6 |
| 6/28/17 | 1.68 | 3.38 | 17.80 | 0.80 | 18.60 | 0.6 |
| 7/5/17 | 1.17 | 3.44 | 18.40 | 0.90 | 19.30 | 0.6 |
| 7/12/17 | 1.31 | 3.41 | 17.90 | 0.75 | 18.65 | 0.6 |
| 7/19/17 | 1.05 | 3.01 | 16.50 | 0.70 | 17.20 | 0.6 |
| 7/26/17 | 1.34 | 3.01 | 15.50 | 1.12 | 16.62 | 0.6 |
| 8/2/17 | 0.90 | 3.25 | 13.60 | 0.63 | 14.23 | 0.3 |
| 8/9/17 | 1.42 | 2.78 | 16.00 | 0.79 | 16.79 | 0.3 |
| 8/16/17 | 2.04 | 3.03 | 13.60 | 1.21 | 14.81 | 0.3 |
| 8/23/17 | 1.48 | 3.83 | 18.40 | 0.63 | 19.03 | 0.3 |
| 8/30/17 | 1.45 | 2.42 | 16.00 | 0.83 | 16.83 | 0.3 |
| 9/6/17 | 1.21 | 2.56 | 14.50 | 0.71 | 15.21 | 0.3 |
| 9/13/17 | 0.84 | 1.24 | 9.35 | 0.79 | 10.14 | 1.0 |
| 9/20/17 | 1.58 | 2.61 | 18.40 | 0.78 | 19.18 | 0.3 |
| 9/27/17 | 1.84 | 3.17 | 19.70 | 0.67 | 20.37 | 0.3 |

Characteristics of Marco Island Reuse Irrigation from 2012 - 2020

| Date | Reuse | | | | | |
|----------|-----------|----------|----------|----------|---------|----------|
| | Flow - MG | PO4 mg/L | NO3 mg/L | TKN mg/L | Total N | TSS mg/L |
| 10/4/17 | 1.02 | 2.64 | 18.80 | 0.46 | 19.26 | 0.3 |
| 10/11/17 | 1.71 | 2.85 | 16.10 | 0.78 | 16.88 | 0.3 |
| 10/18/17 | 1.69 | 3.02 | 16.00 | 0.54 | 16.54 | 0.3 |
| 10/25/17 | 2.78 | 3.04 | 15.70 | 0.94 | 16.64 | 0.3 |
| 11/1/17 | 2.14 | 3.00 | 19.50 | 0.64 | 20.14 | 0.3 |
| 11/8/17 | 2.22 | 3.59 | 14.70 | 1.01 | 15.71 | 0.3 |
| 11/15/17 | 1.98 | 3.08 | 13.70 | 0.70 | 14.40 | 0.3 |
| 11/22/17 | 2.31 | 5.45 | 31.00 | 0.77 | 31.77 | 0.3 |
| 11/29/17 | 2.40 | 3.52 | 8.60 | 0.69 | 9.29 | 0.3 |
| 12/6/17 | 2.25 | 3.49 | 13.30 | 0.89 | 14.19 | 0.3 |
| 12/13/17 | 2.05 | 3.18 | 15.90 | 0.91 | 16.81 | 0.3 |
| 12/20/17 | 2.47 | 3.18 | 12.00 | 0.99 | 12.99 | 0.3 |
| 12/27/17 | 2.63 | 4.58 | 12.10 | 0.96 | 13.06 | 0.3 |
| 1/3/18 | 2.03 | 4.15 | 12.20 | 1.21 | 13.41 | 0.3 |
| 1/10/18 | 2.17 | 4.23 | 12.80 | 1.27 | 14.07 | 0.3 |
| 1/17/18 | 2.24 | 4.60 | 15.20 | 1.13 | 16.33 | 0.3 |
| 1/24/18 | 2.30 | 5.62 | 16.70 | 1.00 | 17.70 | 0.3 |
| 1/31/18 | 2.26 | 5.05 | 15.10 | 0.89 | 15.99 | 0.3 |
| 2/7/18 | 2.54 | 4.82 | 9.56 | 0.97 | 10.53 | 0.3 |
| 2/14/18 | 2.82 | 3.96 | 10.20 | 1.19 | 11.39 | 0.3 |
| 2/21/18 | 2.54 | 1.32 | 9.84 | 0.09 | 9.93 | 0.3 |
| 2/28/18 | 2.64 | 5.09 | 8.71 | 1.38 | 10.09 | 0.3 |
| 3/7/18 | 2.82 | 7.61 | 18.40 | 1.26 | 19.66 | 0.3 |
| 3/14/18 | 2.46 | 4.17 | 6.89 | 0.82 | 7.71 | 0.3 |
| 3/21/18 | 2.06 | 4.71 | 5.97 | 0.57 | 6.54 | 0.3 |
| 3/28/18 | 2.77 | 4.41 | 6.30 | 0.95 | 7.25 | 0.3 |
| 4/4/18 | 2.89 | 4.34 | 5.66 | 1.48 | 7.14 | 0.3 |
| 4/11/18 | 2.48 | 7.42 | 8.94 | 1.31 | 10.25 | 0.3 |
| 4/18/18 | 2.34 | 3.94 | 6.37 | 0.91 | 7.28 | 0.3 |
| 4/25/18 | 2.32 | 4.34 | 8.52 | 0.86 | 9.38 | 0.3 |
| 5/2/18 | 2.73 | 3.17 | 6.57 | 0.86 | 7.43 | 0.3 |
| 5/9/18 | 2.57 | 3.73 | 9.64 | 1.08 | 10.72 | 0.3 |
| 5/16/18 | 1.07 | 3.98 | 16.20 | 0.78 | 16.98 | 0.3 |
| 5/23/18 | 1.19 | 3.49 | 18.30 | 0.51 | 18.81 | 0.3 |
| 5/30/18 | 0.90 | 3.41 | 14.90 | 0.94 | 15.84 | 0.3 |
| 6/6/18 | 1.98 | 3.21 | 10.90 | 0.70 | 11.60 | 0.3 |
| 6/13/18 | 1.95 | 3.06 | 15.50 | 0.70 | 16.20 | 0.3 |
| 6/20/18 | 2.41 | 2.84 | 12.20 | 0.86 | 13.06 | 0.3 |
| 6/27/18 | 1.91 | 3.23 | 17.80 | 0.90 | 18.70 | 0.3 |
| 7/3/18 | 2.45 | 2.94 | 14.60 | 0.65 | 15.25 | 0.3 |
| 7/11/18 | 2.56 | 2.93 | 11.90 | 0.78 | 12.68 | 0.3 |
| 7/18/18 | 2.56 | 5.05 | 27.50 | 0.90 | 28.40 | 0.3 |
| 7/25/18 | 2.92 | 2.38 | 9.70 | 0.98 | 10.68 | 0.3 |
| 8/1/18 | 2.66 | 2.88 | 15.40 | 0.83 | 16.23 | 0.3 |
| 8/8/18 | 2.16 | 3.70 | 20.30 | 0.79 | 21.09 | 0.3 |
| 8/15/18 | 1.87 | 3.22 | 17.50 | 0.87 | 18.37 | 0.3 |
| 8/22/18 | 1.96 | 3.01 | 16.90 | 1.05 | 17.95 | 0.3 |
| 8/29/18 | 1.45 | 2.68 | 14.70 | 0.91 | 15.61 | 0.3 |
| 9/5/18 | 1.52 | 1.94 | 9.61 | 0.93 | 10.54 | 0.3 |
| 9/13/18 | 1.47 | 3.81 | 27.60 | 0.68 | 28.28 | 0.3 |

Characteristics of Marco Island Reuse Irrigation from 2012 - 2020

| Date | Reuse | | | | | |
|----------|-----------|----------|----------|----------|---------|----------|
| | Flow - MG | PO4 mg/L | NO3 mg/L | TKN mg/L | Total N | TSS mg/L |
| 9/19/18 | 2.25 | 3.18 | 12.90 | 0.58 | 13.48 | 0.3 |
| 9/26/18 | 2.21 | 2.53 | 9.47 | 0.73 | 10.20 | 0.3 |
| 10/3/18 | 1.85 | 3.39 | 10.90 | 0.60 | 11.50 | 0.3 |
| 10/10/18 | 2.02 | 2.91 | 9.77 | 0.39 | 10.16 | 0.3 |
| 10/17/18 | 1.89 | 2.98 | 9.55 | 0.79 | 10.34 | 0.7 |
| 10/24/18 | 2.53 | 3.12 | 6.74 | 1.05 | 7.79 | 0.3 |
| 10/31/18 | 2.47 | 3.82 | 11.30 | 0.57 | 11.87 | 0.3 |
| 11/7/18 | 2.84 | 3.25 | 8.00 | 0.59 | 8.59 | 0.3 |
| 11/14/18 | 2.12 | 4.21 | 7.66 | 0.93 | 8.59 | 0.3 |
| 11/21/18 | 2.11 | 2.99 | 8.99 | 0.77 | 9.76 | 0.3 |
| 11/28/18 | 1.82 | 3.32 | 7.40 | 0.50 | 7.90 | 0.3 |
| 12/6/18 | 1.80 | 5.12 | 22.60 | 0.67 | 23.27 | 0.3 |
| 12/12/18 | 2.33 | 3.54 | 8.22 | 0.48 | 8.70 | 0.3 |
| 12/19/18 | 2.35 | 2.06 | 4.45 | 1.14 | 5.59 | 0.3 |
| 12/26/18 | 2.52 | 4.01 | 7.43 | 0.63 | 8.06 | 0.3 |
| 1/2/19 | 2.13 | 4.20 | 4.57 | 1.06 | 5.63 | 0.3 |
| 1/9/19 | 2.35 | 3.25 | 5.49 | 1.24 | 6.73 | 0.3 |
| 1/16/19 | 2.46 | 4.55 | 5.78 | 0.77 | 6.55 | 0.3 |
| 1/23/19 | 2.67 | 4.45 | 4.91 | 1.01 | 5.92 | 0.3 |
| 1/30/19 | 1.31 | 3.33 | 5.41 | 0.39 | 5.80 | 0.3 |
| 2/6/19 | 3.01 | 3.49 | 4.88 | 0.79 | 5.67 | 0.3 |
| 2/13/19 | 1.15 | 3.90 | 4.47 | 0.53 | 5.00 | 0.8 |
| 2/20/19 | 2.63 | 4.57 | 4.65 | 0.89 | 5.54 | 0.3 |
| 2/27/19 | 2.83 | 3.99 | 3.62 | 0.87 | 4.49 | 1.1 |
| 3/6/19 | 2.86 | 3.99 | 6.41 | 1.47 | 7.88 | 0.3 |
| 3/13/19 | 2.99 | 3.66 | 5.43 | 0.64 | 6.07 | 0.3 |
| 3/20/19 | 1.47 | 3.58 | 5.50 | 1.07 | 6.57 | 0.3 |
| 3/27/19 | 2.92 | 3.98 | 5.18 | 0.71 | 5.89 | 0.7 |
| 4/3/19 | 2.70 | 4.35 | 1.07 | 0.74 | 1.81 | 0.3 |
| 4/10/19 | 1.93 | 4.52 | 5.17 | 0.79 | 5.96 | 0.3 |
| 4/17/19 | 2.52 | 4.56 | 5.09 | 0.66 | 5.75 | 0.3 |
| 4/24/19 | 2.55 | 2.92 | 5.28 | 0.89 | 6.17 | 0.3 |
| 5/1/19 | 1.81 | 3.43 | 5.58 | 0.61 | 6.19 | 0.6 |
| 5/8/19 | 2.02 | 4.96 | 7.80 | 0.64 | 8.44 | 0.3 |
| 5/15/19 | 2.03 | 4.31 | 9.24 | 1.13 | 10.37 | 0.3 |
| 5/22/19 | 1.90 | 5.69 | 7.75 | 0.81 | 8.56 | 0.3 |
| 5/29/19 | 2.87 | 2.73 | 5.52 | 0.77 | 6.29 | 0.3 |
| 6/5/19 | 2.68 | 2.84 | 8.74 | 0.68 | 9.42 | 0.3 |
| 6/12/19 | 1.89 | 3.05 | 11.00 | 0.96 | 11.96 | 0.3 |
| 6/19/19 | 1.12 | 1.74 | 8.40 | 0.75 | 9.15 | 0.3 |
| 6/26/19 | 1.99 | 3.09 | 6.43 | 0.78 | 7.21 | 0.3 |
| 7/3/19 | 3.01 | 7.50 | 15.60 | 0.97 | 16.57 | 0.3 |
| 7/10/19 | 2.32 | 4.73 | 13.80 | 0.90 | 14.70 | 0.3 |
| 7/17/19 | 1.31 | 2.94 | 6.20 | 0.83 | 7.03 | 0.3 |
| 7/24/19 | 1.18 | 2.61 | 4.21 | 1.21 | 5.42 | 0.3 |
| 7/31/19 | 2.03 | 3.16 | 7.00 | 0.90 | 7.90 | 0.3 |
| 8/7/19 | 1.13 | 2.46 | 3.79 | 0.88 | 4.67 | 0.3 |
| 8/14/19 | 0.84 | 2.65 | 4.34 | 0.78 | 5.12 | 0.3 |
| 8/21/19 | 1.03 | 2.85 | 4.43 | 0.74 | 5.17 | 0.3 |
| 8/28/19 | 1.08 | 2.83 | 5.99 | 0.62 | 6.61 | 0.3 |

Characteristics of Marco Island Reuse Irrigation from 2012 - 2020

| Date | Reuse | | | | | |
|----------|-----------|----------|----------|----------|---------|----------|
| | Flow - MG | PO4 mg/L | NO3 mg/L | TKN mg/L | Total N | TSS mg/L |
| 9/4/19 | 1.31 | 2.34 | 5.12 | 0.54 | 5.66 | 0.3 |
| 9/11/19 | 2.17 | 7.93 | 23.10 | 0.39 | 23.49 | 0.3 |
| 9/18/19 | 2.01 | 2.50 | 6.69 | 0.50 | 7.19 | 0.3 |
| 9/25/19 | 1.84 | 2.15 | 4.53 | 0.70 | 5.23 | 0.6 |
| 10/2/19 | 2.49 | 0.95 | 3.42 | 0.87 | 4.29 | 3.7 |
| 10/9/19 | 2.00 | 2.13 | 4.61 | 0.97 | 5.58 | 0.7 |
| 10/16/19 | 1.89 | 2.13 | 8.11 | 0.64 | 8.75 | 0.6 |
| 10/23/19 | 2.35 | 1.98 | 4.96 | 1.13 | 6.09 | 0.3 |
| 10/30/19 | 2.26 | 2.08 | 4.31 | 0.67 | 4.98 | 0.3 |
| 11/6/19 | 2.54 | 6.07 | 15.90 | 0.88 | 16.78 | 0.3 |
| 11/13/19 | 2.26 | 2.86 | 6.19 | 1.14 | 7.33 | 0.3 |
| 11/20/19 | 2.24 | 2.70 | 4.21 | 0.94 | 5.15 | 0.3 |
| 11/27/19 | 2.21 | 2.49 | 4.36 | 0.93 | 5.29 | 0.3 |
| 12/4/19 | 1.93 | 2.03 | 4.01 | 0.80 | 4.81 | 0.3 |
| 12/11/19 | 2.01 | 1.33 | 3.11 | 1.00 | 4.11 | 0.3 |
| 12/18/19 | 2.28 | 3.61 | 3.49 | 0.71 | 4.20 | 0.3 |
| 12/25/19 | 1.45 | 2.02 | 4.00 | 0.62 | 4.62 | 0.3 |
| 1/2/20 | 2.23 | 1.18 | 4.89 | 1.00 | 5.89 | 0.3 |
| 1/8/20 | 2.14 | 0.29 | 3.38 | 0.85 | 4.23 | 0.3 |
| 1/15/20 | 2.65 | 1.34 | 3.12 | 0.94 | 4.06 | 0.3 |
| 1/22/20 | 3.05 | 2.86 | 5.35 | 0.93 | 6.28 | 0.3 |
| 1/29/20 | 2.66 | 0.33 | 3.07 | 0.94 | 4.01 | 0.3 |
| 2/5/20 | 1.87 | 0.78 | 4.15 | 0.94 | 5.09 | 0.3 |
| 2/12/20 | 2.41 | 0.08 | 3.85 | 1.17 | 5.02 | 0.3 |
| 2/19/20 | 2.60 | 0.21 | 3.85 | 0.79 | 4.64 | 0.3 |
| 2/26/20 | 2.87 | 5.25 | 2.33 | 0.97 | 3.30 | 0.3 |
| 3/4/20 | 3.04 | 2.54 | 4.44 | 0.73 | 5.17 | 0.3 |
| 3/11/20 | 3.19 | 4.27 | 5.10 | 1.16 | 6.26 | 0.3 |
| 3/18/20 | 3.05 | 11.50 | 6.21 | 0.83 | 7.04 | 0.3 |
| 3/25/20 | 2.34 | 3.74 | 6.01 | 0.88 | 6.89 | 0.3 |
| 4/1/20 | 2.08 | 2.39 | 6.16 | 0.62 | 6.78 | 0.3 |
| 4/8/20 | 2.54 | 3.80 | 7.77 | 0.88 | 8.65 | 0.3 |
| 4/15/20 | 2.50 | 2.05 | 7.19 | 0.80 | 7.99 | 0.3 |
| 4/22/20 | 2.13 | 5.68 | 8.55 | 0.71 | 9.26 | 0.3 |
| 4/29/20 | 2.08 | 8.16 | 8.87 | 0.82 | 9.69 | 0.3 |
| 5/6/20 | 2.33 | 4.38 | 6.70 | 0.73 | 7.43 | 0.3 |
| 5/13/20 | 2.28 | 2.66 | 7.22 | 0.58 | 7.80 | 0.3 |
| 5/20/20 | 1.92 | 2.49 | 5.52 | 0.48 | 6.00 | 0.3 |
| 5/27/20 | 1.89 | 2.40 | 2.86 | 0.53 | 3.39 | 0.3 |
| 6/3/20 | 1.67 | 1.55 | 3.84 | 0.94 | 4.78 | 0.3 |
| 6/10/20 | 1.38 | 5.48 | 16.30 | 0.78 | 17.08 | 0.3 |
| 6/17/20 | 1.11 | 2.43 | 3.91 | 0.68 | 4.59 | 0.3 |
| 6/24/20 | 2.39 | 2.75 | 4.10 | 0.86 | 4.96 | 0.3 |
| 7/1/20 | 2.48 | 3.32 | 4.68 | 0.44 | 5.12 | 0.3 |
| 7/8/20 | 2.55 | 2.53 | 3.73 | 0.78 | 4.51 | 0.3 |
| 7/15/20 | 2.21 | 3.10 | 4.05 | 0.55 | 4.60 | 0.3 |
| 7/22/20 | 1.17 | 1.93 | 3.34 | 0.66 | 4.00 | 0.3 |
| 7/29/20 | 1.30 | 2.84 | 3.88 | 0.68 | 4.56 | 0.3 |
| 8/5/20 | 1.98 | 5.09 | 9.20 | 0.72 | 9.92 | 0.3 |
| 8/12/20 | 1.31 | 2.69 | 5.81 | 0.61 | 6.42 | 0.3 |

Characteristics of Marco Island Reuse Irrigation from 2012 - 2020

| Date | Reuse | | | | | |
|------------|-----------|----------|----------|----------|---------|----------|
| | Flow - MG | PO4 mg/L | NO3 mg/L | TKN mg/L | Total N | TSS mg/L |
| 8/19/20 | 1.42 | 2.35 | 3.65 | 0.68 | 4.33 | 0.3 |
| 8/26/20 | 1.98 | 2.76 | 4.08 | 0.59 | 4.67 | 0.3 |
| 9/2/20 | 2.00 | 3.04 | 4.80 | 0.69 | 5.49 | 0.3 |
| 9/9/20 | 0.96 | 2.65 | 4.73 | 0.88 | 5.61 | 0.3 |
| 9/16/20 | 1.41 | 1.35 | 8.00 | 0.95 | 8.95 | 0.3 |
| 9/23/20 | 2.34 | 2.26 | 10.20 | 0.57 | 10.77 | 0.3 |
| 9/30/20 | 2.36 | 2.38 | 5.46 | 0.68 | 6.14 | 0.3 |
| 10/7/20 | 2.25 | 6.19 | 24.90 | 1.32 | 26.22 | 0.3 |
| 10/14/20 | 2.41 | 2.88 | 5.07 | 0.75 | 5.82 | 0.3 |
| 10/21/20 | 1.98 | 3.22 | 2.89 | 0.53 | 3.42 | 0.3 |
| 10/28/20 | 1.53 | 2.69 | 2.89 | 0.57 | 3.46 | 0.3 |
| 11/4/20 | 2.59 | 2.85 | 4.02 | 0.80 | 4.82 | 0.3 |
| 11/11/20 | 0.97 | 2.38 | 6.58 | 0.74 | 7.32 | 0.3 |
| 11/18/20 | 2.14 | 2.82 | 7.08 | 0.97 | 8.05 | 0.3 |
| 11/25/20 | 2.63 | 3.05 | 5.98 | 0.82 | 6.80 | 0.3 |
| 12/2/20 | 2.30 | 3.80 | 5.06 | 0.94 | 6.00 | 0.3 |
| 12/9/20 | 2.19 | 2.44 | 7.40 | 0.48 | 7.88 | 0.3 |
| 12/16/20 | 2.34 | 3.61 | 4.88 | 1.22 | 6.10 | 0.3 |
| 12/23/20 | 2.09 | 2.43 | 4.48 | 1.53 | 6.01 | 0.3 |
| 12/30/20 | 2.36 | 3.37 | 7.35 | 0.81 | 8.16 | 0.3 |
| 1/6/21 | 2.66 | 2.79 | 5.95 | 0.89 | 6.84 | 0.3 |
| 1/13/21 | 1.46 | 5.29 | 6.93 | 0.81 | 7.74 | 0.3 |
| 1/20/21 | 2.31 | 4.68 | 6.74 | 1.59 | 8.33 | 0.3 |
| 1/27/21 | 2.27 | 3.85 | 4.13 | 0.63 | 4.76 | 0.3 |
| 2/3/21 | 2.49 | 4.27 | 5.15 | 0.76 | 5.91 | 0.3 |
| 2/10/21 | 2.56 | 4.47 | 4.04 | 0.86 | 4.90 | 0.3 |
| 2/17/21 | 1.54 | 3.20 | 4.06 | 0.94 | 5.00 | 0.3 |
| 2/24/21 | 2.59 | 2.54 | 2.60 | 0.82 | 3.42 | 0.3 |
| 3/3/21 | 2.93 | 3.22 | 4.53 | 0.84 | 5.37 | 0.3 |
| 3/10/21 | 2.53 | 4.65 | 5.14 | 1.44 | 6.58 | 0.3 |
| 3/17/21 | 3.08 | 3.77 | 5.03 | 0.74 | 5.77 | 0.3 |
| 3/24/21 | 2.82 | 3.94 | 5.28 | 0.89 | 6.17 | 0.3 |
| 3/31/21 | 3.15 | 3.31 | 5.47 | 0.77 | 6.24 | 2.0 |
| 4/7/21 | 2.82 | 3.55 | 5.66 | 0.91 | 6.57 | 0.3 |
| 4/14/21 | 1.99 | 5.22 | 5.18 | 0.71 | 5.89 | 0.3 |
| 4/21/21 | 2.35 | 3.37 | 5.30 | 0.65 | 5.95 | 0.3 |
| 4/28/21 | 2.44 | 3.41 | 5.67 | 0.63 | 6.30 | 0.3 |
| 5/5/21 | 2.88 | 4.01 | 5.43 | 0.62 | 6.05 | 0.3 |
| 5/12/21 | 2.58 | 2.88 | 2.90 | 0.73 | 3.63 | 0.3 |
| 5/19/21 | 2.84 | 2.41 | 4.26 | 0.75 | 5.01 | 0.3 |
| 5/26/21 | 2.76 | 5.00 | 3.02 | 1.07 | 4.09 | 0.3 |
| 6/2/21 | 2.45 | 3.50 | 4.31 | 1.10 | 5.41 | 0.3 |
| Min. Value | 0.54 | 0.08 | 0.01 | 0.09 | 0.56 | 0.30 |
| Max. Value | 3.19 | 11.50 | 31.00 | 6.76 | 31.77 | 3.70 |
| Geomean: | 1.87 | 3.33 | 7.49 | 0.89 | 8.63 | 0.47 |

APPENDIX B

RESULTS OF SURFACE WATER QUALITY MONITORING CONDUCTED IN MARCO ISLAND WATERWAYS FROM APRIL – SEPTEMBER 2020

B-1 Vertical Field Profiles

B-2 Characteristics of Surface Water Samples

B-1 Vertical Field Profiles

Vertical Profiles Collected in Marco Island Surface Waters from April - September 2020

| Site | Date | Time | Depth (m) | Temp. (°C) | pH (s.u.) | Cond. (µmho/cm) | Salinity (ppt) | Diss. O ₂ (mg/L) | Diss. O ₂ (% Sat.) | ORP (mV) | Secchi (m) |
|------|---------|-------|-----------|------------|-----------|-----------------|----------------|-----------------------------|-------------------------------|----------|------------|
| M-1 | 5/5/20 | 8:14 | 0.5 | 26.93 | 7.90 | 55,765 | 37.1 | 6.3 | 98 | 433 | 2.37 |
| | | 8:14 | 1.0 | 26.93 | 7.90 | 55,762 | 37.1 | 6.3 | 97 | 434 | |
| | | 8:15 | 1.8 | 26.93 | 7.90 | 55,771 | 37.1 | 6.3 | 98 | 434 | |
| M-1 | 5/26/20 | 17:32 | 0.5 | 28.83 | 7.83 | 56,040 | 37.3 | 6.8 | 108 | 439 | 1.32 |
| | | 17:34 | 1.0 | 28.82 | 7.83 | 56,030 | 37.3 | 6.8 | 108 | 441 | |
| | | 17:34 | 2.0 | 28.81 | 7.83 | 56,037 | 37.3 | 6.8 | 108 | 442 | |
| | | 17:35 | 2.6 | 28.81 | 7.83 | 56,046 | 37.3 | 6.8 | 108 | 442 | |
| M-1 | 6/29/20 | 16:07 | 0.5 | 33.09 | 7.81 | 53,841 | 35.7 | 6.1 | 102 | 419 | 1.07 |
| | | 16:08 | 1.0 | 32.93 | 7.80 | 53,778 | 35.6 | 6.0 | 101 | 420 | |
| | | 16:08 | 2.0 | 32.85 | 7.80 | 53,812 | 35.6 | 5.9 | 100 | 421 | |
| M-1 | 7/27/20 | 10:01 | 0.5 | 29.82 | 8.12 | 49,963 | 32.8 | 5.6 | 88 | 448 | 1.71 |
| | | 10:01 | 1.0 | 29.74 | 8.12 | 50,581 | 33.3 | 5.5 | 87 | 449 | |
| | | 10:03 | 2.0 | 29.70 | 8.12 | 50,866 | 33.5 | 5.5 | 87 | 449 | |
| | | 10:02 | 2.6 | 29.70 | 8.12 | 50,928 | 33.5 | 5.5 | 87 | 449 | |
| M-1 | 8/31/20 | 16:25 | 0.5 | 32.33 | 8.07 | 51,552 | 34.0 | 5.5 | 90 | 417 | 0.97 |
| | | 16:26 | 1.0 | 32.34 | 8.06 | 51,643 | 34.0 | 5.5 | 90 | 416 | |
| | | 16:26 | 2.0 | 32.35 | 8.07 | 51,780 | 34.1 | 5.4 | 90 | 417 | |
| | | 16:27 | 2.5 | 32.35 | 8.06 | 51,763 | 34.1 | 5.5 | 90 | 415 | |
| M-1 | 9/23/20 | 14:05 | 0.5 | 28.37 | 8.13 | 45,087 | 29.2 | 6.0 | 91 | 447 | 1.42 |
| | | 14:05 | 1.0 | 28.32 | 8.14 | 45,387 | 29.5 | 5.8 | 88 | 446 | |
| | | 14:06 | 2.0 | 28.34 | 8.14 | 45,648 | 29.6 | 5.7 | 87 | 445 | |
| | | 14:06 | 2.3 | 28.34 | 8.14 | 45,735 | 29.7 | 5.8 | 88 | 444 | |
| M-2 | 5/5/20 | 11:46 | 0.5 | 28.01 | 7.80 | 55,783 | 37.1 | 6.5 | 102 | 390 | 1.13 |
| | | 11:47 | 1.0 | 28.01 | 7.80 | 55,853 | 37.2 | 6.5 | 102 | 391 | |
| | | 11:48 | 1.9 | 28.00 | 7.84 | 55,805 | 37.1 | 6.5 | 102 | 395 | |
| M-2 | 5/27/20 | 10:11 | 0.5 | 28.86 | 7.54 | 56,834 | 37.9 | 5.1 | 81 | 454 | 1.18 |
| | | 10:11 | 1.0 | 28.71 | 7.53 | 56,871 | 37.9 | 4.9 | 78 | 454 | |
| | | 10:12 | 1.5 | 28.49 | 7.53 | 56,952 | 38.0 | 4.9 | 77 | 454 | |
| | | 10:12 | 2.0 | 28.49 | 7.53 | 56,968 | 38.0 | 4.7 | 75 | 453 | |
| | | 10:13 | 2.0 | 28.52 | 7.54 | 56,964 | 38.0 | 4.7 | 75 | 453 | |
| M-2 | 6/29/20 | 18:44 | 0.5 | 32.78 | 7.86 | 53,794 | 35.6 | 6.1 | 103 | 374 | 1.22 |
| | | 18:44 | 1.0 | 32.79 | 7.86 | 53,766 | 35.6 | 6.1 | 103 | 376 | |
| | | 18:45 | 1.3 | 32.80 | 7.86 | 53,787 | 35.6 | 6.1 | 102 | 377 | |
| M-2 | 7/27/20 | 12:26 | 0.5 | 30.83 | 8.02 | 47,656 | 31.1 | 6.0 | 95 | 408 | 0.61 |
| | | 12:27 | 1.0 | 30.79 | 8.04 | 47,895 | 31.3 | 6.0 | 95 | 408 | |
| | | 12:27 | 1.3 | 30.86 | 8.05 | 47,957 | 31.3 | 6.0 | 95 | 408 | |
| M-2 | 8/31/20 | 19:03 | 0.5 | 32.01 | 8.00 | 51,195 | 33.7 | 5.2 | 85 | 373 | 0.48 |
| | | 19:04 | 1.0 | 32.02 | 8.02 | 51,311 | 33.9 | 5.2 | 85 | 373 | |
| | | 19:05 | 1.4 | 32.11 | 8.03 | 51,406 | 33.9 | 5.1 | 85 | 373 | |
| M-2 | 9/23/20 | 16:21 | 0.5 | 28.58 | 8.26 | 46,308 | 30.1 | 6.2 | 96 | 358 | 1.22 |
| | | 16:22 | 1.0 | 28.58 | 8.26 | 46,408 | 30.2 | 6.2 | 95 | 361 | |
| | | 16:22 | 1.5 | 28.59 | 8.26 | 46,490 | 30.3 | 6.2 | 96 | 361 | |

Vertical Profiles Collected in Marco Island Surface Waters from April - September 2020

| Site | Date | Time | Depth (m) | Temp. (°C) | pH (s.u.) | Cond. (µmho/cm) | Salinity (ppt) | Diss. O ₂ (mg/L) | Diss. O ₂ (% Sat.) | ORP (mV) | Secchi (m) |
|------|---------|-------|-----------|------------|-----------|-----------------|----------------|-----------------------------|-------------------------------|----------|------------|
| M-3 | 4/29/20 | 14:56 | 0.5 | 27.51 | 7.90 | 57,202 | 38.2 | 7.2 | 112 | 368 | 2.19 |
| | | 14:56 | 1.0 | 27.50 | 7.90 | 57,209 | 38.2 | 7.2 | 112 | 368 | |
| | | 14:57 | 2.0 | 27.48 | 7.89 | 57,207 | 38.2 | 7.1 | 112 | 369 | |
| | | 14:58 | 3.0 | 27.44 | 7.89 | 57,221 | 38.2 | 7.1 | 112 | 369 | |
| | | 14:59 | 3.2 | 27.41 | 7.89 | 57,228 | 38.2 | 7.0 | 110 | 370 | |
| M-3 | 5/27/20 | 17:58 | 0.5 | 29.28 | 7.91 | 56,916 | 37.9 | 6.9 | 111 | 387 | 1.44 |
| | | 17:59 | 1.0 | 29.32 | 7.91 | 56,886 | 37.9 | 6.9 | 111 | 388 | |
| | | 18:00 | 2.0 | 29.37 | 7.91 | 56,856 | 37.9 | 6.9 | 111 | 389 | |
| | | 18:00 | 3.0 | 29.35 | 7.91 | 56,882 | 37.9 | 6.9 | 111 | 389 | |
| | | 18:01 | 4.0 | 29.34 | 7.91 | 56,862 | 37.9 | 6.9 | 111 | 390 | |
| | | 18:01 | 4.9 | 29.32 | 7.91 | 56,879 | 37.9 | 6.9 | 111 | 390 | |
| M-3 | 6/30/20 | 10:48 | 0.5 | 32.31 | 8.01 | 55,012 | 36.5 | 6.5 | 109 | 412 | 2.07 |
| | | 10:49 | 1.0 | 32.31 | 8.01 | 55,015 | 36.5 | 6.5 | 109 | 413 | |
| | | 10:49 | 2.0 | 32.32 | 8.01 | 55,020 | 36.5 | 6.5 | 109 | 413 | |
| | | 10:50 | 3.0 | 32.32 | 8.01 | 55,028 | 36.5 | 6.5 | 109 | 413 | |
| | | 10:51 | 4.0 | 32.31 | 8.01 | 55,031 | 36.5 | 6.5 | 109 | 413 | |
| | | 10:52 | 4.2 | 32.00 | 8.01 | 55,056 | 36.5 | 6.5 | 109 | 413 | |
| M-3 | 7/28/20 | 11:08 | 0.5 | 29.86 | 8.20 | 51,298 | 33.8 | 5.3 | 84 | 412 | 0.93 |
| | | 11:09 | 1.0 | 29.86 | 8.20 | 51,435 | 33.9 | 5.3 | 85 | 412 | |
| | | 11:10 | 2.0 | 29.84 | 8.19 | 51,590 | 34.0 | 5.3 | 84 | 411 | |
| | | 11:10 | 3.0 | 29.85 | 8.19 | 51,573 | 34.0 | 5.3 | 84 | 410 | |
| | | 11:11 | 4.0 | 29.85 | 8.19 | 51,626 | 34.0 | 5.3 | 84 | 409 | |
| | | 11:11 | 4.9 | 29.85 | 8.19 | 51,743 | 34.0 | 5.3 | 84 | 409 | |
| M-3 | 9/1/20 | 11:28 | 0.5 | 31.26 | 8.11 | 53,899 | 35.7 | 5.4 | 88 | 424 | SOB |
| | | 11:28 | 1.0 | 31.20 | 8.11 | 54,374 | 36.1 | 5.1 | 84 | 423 | |
| | | 11:29 | 2.0 | 31.18 | 8.11 | 54,872 | 36.4 | 4.9 | 81 | 421 | |
| | | 11:29 | 3.0 | 31.18 | 8.12 | 55,012 | 36.5 | 4.9 | 80 | 421 | |
| | | 11:29 | 4.0 | 31.19 | 8.12 | 55,025 | 36.5 | 4.9 | 81 | 420 | |
| | | 11:30 | 4.6 | 31.19 | 8.12 | 55,062 | 36.5 | 4.8 | 81 | 265 | |
| M-3 | 9/24/20 | 11:18 | 0.5 | 28.21 | 8.12 | 49,430 | 32.4 | 5.6 | 87 | 462 | 1.73 |
| | | 11:18 | 1.0 | 28.17 | 8.13 | 49,625 | 32.6 | 5.7 | 87 | 461 | |
| | | 11:18 | 2.0 | 28.15 | 8.14 | 49,984 | 32.8 | 5.8 | 89 | 458 | |
| | | 11:19 | 3.0 | 28.17 | 8.15 | 50,455 | 33.2 | 5.9 | 92 | 453 | |
| | | 11:20 | 4.0 | 28.19 | 8.17 | 50,605 | 33.3 | 6.0 | 92 | 449 | |
| | | 11:21 | 4.7 | 28.19 | 8.18 | 50,678 | 33.3 | 5.9 | 92 | 430 | |

Vertical Profiles Collected in Marco Island Surface Waters from April - September 2020

| Site | Date | Time | Depth (m) | Temp. (°C) | pH (s.u.) | Cond. (µmho/cm) | Salinity (ppt) | Diss. O ₂ (mg/L) | Diss. O ₂ (% Sat.) | ORP (mV) | Secchi (m) |
|------|---------|-------|-----------|------------|-----------|-----------------|----------------|-----------------------------|-------------------------------|----------|------------|
| M-4 | 4/29/20 | 17:49 | 0.5 | 27.55 | 7.89 | 57,246 | 38.2 | 7.1 | 112 | 331 | 1.63 |
| | | 17:50 | 1.0 | 27.41 | 7.88 | 57,251 | 38.2 | 7.1 | 112 | 331 | |
| | | 17:50 | 2.0 | 27.35 | 7.88 | 57,296 | 38.2 | 7.0 | 110 | 332 | |
| | | 17:51 | 3.0 | 27.35 | 7.88 | 57,276 | 38.2 | 7.0 | 110 | 333 | |
| | | 17:51 | 3.6 | 27.35 | 7.88 | 57,240 | 38.2 | 7.0 | 110 | 334 | |
| M-4 | 5/27/20 | 14:19 | 0.5 | 29.27 | 7.92 | 56,869 | 37.9 | 6.9 | 111 | 368 | 1.42 |
| | | 14:20 | 1.0 | 29.25 | 7.92 | 56,851 | 37.9 | 6.9 | 111 | 370 | |
| | | 14:20 | 2.0 | 29.24 | 7.92 | 56,855 | 37.9 | 6.9 | 111 | 373 | |
| | | 14:21 | 3.0 | 29.24 | 7.92 | 56,871 | 37.9 | 6.9 | 110 | 375 | |
| | | 14:21 | 3.7 | 29.24 | 7.91 | 56,880 | 37.9 | 6.9 | 111 | 376 | |
| M-4 | 6/30/20 | 10:39 | 0.5 | 32.20 | 8.00 | 54,966 | 36.5 | 6.0 | 100 | 403 | 2.19 |
| | | 10:40 | 1.0 | 32.21 | 7.99 | 54,982 | 36.5 | 6.0 | 100 | 401 | |
| | | 10:41 | 2.0 | 32.19 | 7.99 | 55,003 | 36.5 | 6.0 | 100 | 401 | |
| | | 10:41 | 3.0 | 32.17 | 7.99 | 54,986 | 36.5 | 6.0 | 100 | 400 | |
| | | 10:42 | 3.8 | 32.18 | 7.99 | 54,996 | 36.5 | 6.0 | 100 | 399 | |
| M-4 | 7/28/20 | 10:56 | 0.5 | 29.88 | 8.23 | 51,325 | 33.8 | 5.4 | 86 | 420 | 0.97 |
| | | 10:56 | 1.0 | 29.87 | 8.22 | 51,410 | 33.9 | 5.4 | 86 | 419 | |
| | | 10:57 | 2.0 | 29.85 | 8.22 | 51,568 | 34.0 | 5.4 | 86 | 417 | |
| | | 10:57 | 3.0 | 29.83 | 8.21 | 51,812 | 34.2 | 5.3 | 85 | 414 | |
| | | 10:57 | 3.6 | 29.82 | 8.21 | 51,897 | 34.2 | 5.3 | 85 | 414 | |
| M-4 | 9/1/20 | 13:54 | 0.5 | 32.04 | 8.24 | 53,805 | 35.6 | 6.2 | 102 | 286 | 3.34 |
| | | 13:54 | 1.0 | 31.86 | 8.23 | 53,836 | 35.7 | 5.9 | 97 | 294 | |
| | | 13:55 | 2.0 | 31.78 | 8.21 | 54,146 | 35.9 | 5.6 | 92 | 295 | |
| | | 13:55 | 3.0 | 31.61 | 8.19 | 54,357 | 36.0 | 5.2 | 86 | 297 | |
| | | 13:56 | 4.0 | 31.61 | 8.19 | 54,470 | 36.1 | 5.1 | 85 | 299 | |
| | | 13:56 | 4.2 | 31.61 | 8.19 | 54,492 | 36.1 | 5.1 | 85 | 300 | |
| M-4 | 9/24/20 | 13:33 | 0.5 | 28.63 | 8.29 | 47,775 | 31.2 | 6.3 | 97 | 332 | 0.94 |
| | | 13:34 | 1.0 | 28.53 | 8.28 | 47,993 | 31.4 | 6.1 | 94 | 336 | |
| | | 13:35 | 2.0 | 28.52 | 8.27 | 48,114 | 31.4 | 6.0 | 93 | 339 | |
| | | 13:35 | 3.0 | 28.50 | 8.27 | 48,162 | 31.5 | 5.9 | 92 | 340 | |
| | | 13:36 | 3.4 | 28.51 | 8.27 | 48,180 | 31.5 | 5.9 | 91 | 340 | |
| M-5 | 4/29/20 | 15:32 | 0.5 | 28.45 | 7.91 | 57,164 | 38.1 | 7.7 | 123 | 367 | 0.76 |
| | | 15:33 | 1.0 | 28.44 | 7.91 | 57,169 | 38.1 | 7.7 | 123 | 367 | |
| | | 15:34 | 1.3 | 28.44 | 7.91 | 57,151 | 38.1 | 7.8 | 124 | 366 | |
| M-5 | 5/26/20 | 17:00 | 0.5 | 29.86 | 7.88 | 55,617 | 37.0 | 7.7 | 124 | 440 | 1.43 |
| | | 17:00 | 1.0 | 29.74 | 7.89 | 55,693 | 37.0 | 7.7 | 125 | 442 | |
| | | 17:01 | 2.0 | 29.11 | 7.88 | 56,047 | 37.3 | 7.1 | 114 | 441 | |
| | | 17:01 | 2.2 | 29.09 | 7.88 | 56,074 | 37.3 | 7.1 | 114 | 441 | |
| M-5 | 6/29/20 | 15:34 | 0.5 | 33.18 | 7.88 | 53,128 | 35.1 | 6.8 | 114 | 425 | 0.88 |
| | | 15:35 | 1.0 | 33.15 | 7.89 | 53,113 | 35.1 | 6.8 | 114 | 425 | |
| | | 15:35 | 1.5 | 33.14 | 7.89 | 53,111 | 35.1 | 6.7 | 113 | 425 | |
| M-5 | 7/27/20 | 9:36 | 0.5 | 29.78 | 8.14 | 49,537 | 32.5 | 5.9 | 93 | 441 | 0.93 |
| | | 9:37 | 1.0 | 29.63 | 8.13 | 49,954 | 32.8 | 5.9 | 92 | 442 | |
| | | 9:37 | 1.9 | 29.74 | 8.13 | 51,643 | 34.0 | 5.4 | 86 | 443 | |
| M-5 | 8/31/20 | 16:01 | 0.5 | 32.40 | 8.13 | 51,138 | 33.7 | 6.2 | 103 | 420 | 0.96 |
| | | 16:01 | 1.0 | 32.32 | 8.12 | 51,338 | 33.8 | 6.1 | 100 | 419 | |
| | | 16:02 | 1.6 | 32.26 | 8.12 | 51,478 | 33.9 | 6.0 | 99 | 417 | |
| M-5 | 9/23/20 | 13:43 | 0.5 | 29.61 | 8.30 | 43,832 | 28.3 | 7.8 | 120 | 440 | 0.84 |
| | | 13:43 | 1.0 | 29.21 | 8.25 | 46,525 | 30.3 | 6.7 | 104 | 439 | |
| | | 13:44 | 1.5 | 29.16 | 8.31 | 49,051 | 32.1 | 7.1 | 111 | 437 | |

Vertical Profiles Collected in Marco Island Surface Waters from April - September 2020

| Site | Date | Time | Depth (m) | Temp. (°C) | pH (s.u.) | Cond. (µmho/cm) | Salinity (ppt) | Diss. O ₂ (mg/L) | Diss. O ₂ (% Sat.) | ORP (mV) | Secchi (m) |
|------|---------|-------|-----------|------------|-----------|-----------------|----------------|-----------------------------|-------------------------------|----------|------------|
| M-6 | 5/5/20 | 7:01 | 0.5 | 27.56 | 7.66 | 54,646 | 36.3 | 5.2 | 81 | 495 | 1.81 |
| | | 7:02 | 1.0 | 27.57 | 7.68 | 54,649 | 36.3 | 5.2 | 82 | 494 | |
| | | 7:02 | 2.0 | 27.55 | 7.68 | 54,659 | 36.3 | 5.2 | 81 | 492 | |
| | | 7:03 | 3.0 | 27.55 | 7.69 | 54,650 | 36.3 | 5.2 | 81 | 492 | |
| | | 7:04 | 3.6 | 27.55 | 7.67 | 54,658 | 36.3 | 5.1 | 79 | 489 | |
| M-6 | 5/26/20 | 16:29 | 1.0 | 29.20 | 7.78 | 54,480 | 36.1 | 6.5 | 104 | 421 | 1.78 |
| | | 16:30 | 2.0 | 28.52 | 7.76 | 54,908 | 36.5 | 6.0 | 94 | 422 | |
| | | 16:31 | 3.0 | 28.39 | 7.73 | 55,056 | 36.6 | 5.6 | 88 | 422 | |
| | | 16:32 | 3.9 | 28.40 | 7.73 | 55,033 | 36.5 | 5.2 | 82 | 423 | |
| M-6 | 6/29/20 | 15:12 | 0.5 | 33.30 | 7.87 | 51,692 | 34.1 | 6.7 | 112 | 409 | 1.23 |
| | | 15:12 | 1.0 | 33.09 | 7.88 | 51,660 | 34.1 | 6.8 | 113 | 412 | |
| | | 15:13 | 2.0 | 32.73 | 7.86 | 52,038 | 34.3 | 6.4 | 107 | 415 | |
| | | 15:14 | 2.9 | 32.54 | 7.82 | 52,580 | 34.7 | 5.7 | 95 | 415 | |
| M-6 | 7/27/20 | 7:59 | 0.5 | 29.87 | 7.98 | 47,826 | 31.2 | 6.0 | 93 | 547 | 1.71 |
| | | 8:00 | 1.0 | 30.12 | 7.97 | 48,506 | 31.7 | 5.7 | 90 | 540 | |
| | | 8:00 | 2.0 | 30.37 | 7.96 | 49,693 | 32.6 | 5.3 | 84 | 536 | |
| | | 8:01 | 3.0 | 30.41 | 7.97 | 49,781 | 32.7 | 5.4 | 85 | 532 | |
| | | 8:01 | 4.0 | 30.36 | 7.97 | 49,998 | 32.8 | 5.3 | 84 | 529 | |
| | | 8:02 | 4.4 | 30.28 | 7.92 | 50,005 | 32.8 | 5.1 | 81 | 519 | |
| M-6 | 8/31/20 | 13:45 | 0.5 | 32.88 | 7.98 | 50,597 | 33.3 | 5.3 | 88 | 436 | 1.08 |
| | | 13:45 | 1.0 | 32.43 | 7.98 | 50,706 | 33.3 | 5.3 | 88 | 433 | |
| | | 13:46 | 2.0 | 32.02 | 7.95 | 51,000 | 33.6 | 4.4 | 73 | 430 | |
| | | 13:46 | 3.0 | 31.97 | 7.96 | 51,225 | 33.7 | 4.5 | 74 | 430 | |
| | | 13:47 | 4.0 | 31.92 | 7.94 | 51,088 | 33.6 | 4.2 | 69 | 426 | |
| M-6 | 9/23/20 | 13:19 | 0.5 | 30.05 | 8.28 | 41,260 | 26.5 | 7.4 | 113 | 386 | 1.69 |
| | | 13:19 | 1.0 | 29.73 | 8.28 | 41,482 | 26.6 | 7.4 | 114 | 397 | |
| | | 13:20 | 2.0 | 29.61 | 8.17 | 42,743 | 27.5 | 5.8 | 90 | 400 | |
| | | 13:21 | 3.0 | 29.60 | 8.13 | 45,473 | 29.5 | 4.8 | 75 | 401 | |
| | | 13:21 | 3.4 | 29.62 | 8.13 | 45,611 | 29.6 | 4.8 | 74 | 399 | |

Vertical Profiles Collected in Marco Island Surface Waters from April - September 2020

| Site | Date | Time | Depth (m) | Temp. (°C) | pH (s.u.) | Cond. (µmho/cm) | Salinity (ppt) | Diss. O ₂ (mg/L) | Diss. O ₂ (% Sat.) | ORP (mV) | Secchi (m) |
|------|---------|-------|-----------|------------|-----------|-----------------|----------------|-----------------------------|-------------------------------|----------|------------|
| M-7 | 4/29/20 | 16:01 | 0.5 | 28.13 | 7.85 | 56,835 | 37.9 | 8.0 | 127 | 372 | 1.13 |
| | | 16:01 | 1.0 | 28.10 | 7.85 | 56,841 | 37.9 | 8.0 | 127 | 372 | |
| | | 16:02 | 2.0 | 27.67 | 7.83 | 56,879 | 37.9 | 7.6 | 120 | 372 | |
| | | 16:02 | 2.1 | 27.63 | 7.83 | 56,809 | 37.9 | 7.5 | 118 | 372 | |
| M-7 | 5/26/20 | 15:18 | 0.5 | 29.55 | 7.75 | 54,858 | 36.4 | 7.5 | 121 | 428 | 1.44 |
| | | 15:19 | 1.0 | 29.49 | 7.76 | 54,806 | 36.4 | 7.5 | 120 | 429 | |
| | | 15:19 | 2.0 | 28.73 | 7.73 | 54,907 | 36.5 | 7.0 | 112 | 428 | |
| | | 15:20 | 2.3 | 28.75 | 7.73 | 55,110 | 36.6 | 7.0 | 111 | 428 | |
| M-7 | 6/29/20 | 13:37 | 0.5 | 32.83 | 7.66 | 52,297 | 34.5 | 5.7 | 95 | 456 | 1.16 |
| | | 13:37 | 1.0 | 32.65 | 7.67 | 52,490 | 34.7 | 5.6 | 92 | 455 | |
| | | 13:38 | 1.5 | 32.55 | 7.68 | 52,610 | 34.8 | 5.5 | 92 | 454 | |
| | | 13:38 | 1.9 | 32.52 | 7.69 | 52,665 | 34.8 | 5.6 | 93 | 454 | |
| M-7 | 7/27/20 | 8:22 | 0.5 | 30.24 | 8.12 | 49,142 | 32.2 | 6.3 | 100 | 480 | 1.39 |
| | | 8:22 | 1.0 | 30.32 | 8.11 | 49,195 | 32.2 | 6.3 | 99 | 479 | |
| | | 8:23 | 2.0 | 30.21 | 8.09 | 49,763 | 32.7 | 6.1 | 97 | 478 | |
| | | 8:23 | 2.2 | 30.13 | 8.08 | 49,833 | 32.7 | 5.5 | 87 | 475 | |
| M-7 | 8/31/20 | 12:39 | 0.5 | 32.86 | 8.10 | 50,665 | 33.3 | 6.5 | 108 | 264 | 0.98 |
| | | 12:39 | 1.0 | 32.53 | 8.09 | 50,935 | 33.5 | 6.4 | 107 | 263 | |
| | | 12:40 | 2.0 | 32.12 | 8.04 | 51,171 | 33.7 | 5.5 | 90 | 260 | |
| | | 12:40 | 2.8 | 32.10 | 8.04 | 51,293 | 33.8 | 5.5 | 91 | 260 | |
| M-7 | 9/23/20 | 12:58 | 0.5 | 29.62 | 8.21 | 42,606 | 27.4 | 6.8 | 105 | 400 | 1.34 |
| | | 12:58 | 1.0 | 29.47 | 8.22 | 42,908 | 27.7 | 7.0 | 107 | 402 | |
| | | 12:58 | 2.0 | 29.29 | 8.20 | 43,926 | 28.4 | 6.8 | 104 | 403 | |
| | | 12:59 | 3.0 | 29.30 | 8.16 | 44,737 | 29.0 | 5.9 | 92 | 402 | |
| | | 12:59 | 4.0 | 29.22 | 8.09 | 47,345 | 30.9 | 4.1 | 64 | 399 | |
| | | 13:00 | 4.3 | 29.23 | 8.05 | 47,306 | 30.9 | 3.9 | 61 | 397 | |
| M-8 | 5/5/20 | 10:44 | 0.5 | 28.13 | 7.78 | 55,405 | 36.8 | 5.9 | 94 | 437 | 1.87 |
| | | 10:44 | 1.0 | 27.85 | 7.80 | 55,365 | 36.8 | 6.3 | 99 | 439 | |
| | | 10:45 | 2.0 | 27.79 | 7.80 | 55,651 | 37.0 | 5.7 | 90 | 440 | |
| | | 10:46 | 2.8 | 27.64 | 7.81 | 55,820 | 37.1 | 5.7 | 89 | 440 | |
| M-8 | 5/26/20 | 8:36 | 0.5 | 30.44 | 7.89 | 55,704 | 37.0 | 7.8 | 127 | 443 | 1.47 |
| | | 8:36 | 1.0 | 29.30 | 7.89 | 55,652 | 37.0 | 8.1 | 130 | 444 | |
| | | 8:37 | 2.0 | 28.52 | 7.83 | 55,782 | 37.1 | 7.0 | 110 | 442 | |
| | | 8:38 | 2.8 | 28.30 | 7.63 | 54,429 | 36.1 | 6.3 | 99 | 379 | |
| M-8 | 6/29/20 | 16:21 | 0.5 | 33.43 | 7.94 | 53,697 | 35.6 | 7.1 | 119 | 431 | 1.36 |
| | | 16:22 | 1.0 | 33.31 | 7.94 | 53,591 | 35.5 | 7.2 | 122 | 432 | |
| | | 16:22 | 2.0 | 32.44 | 7.94 | 53,884 | 35.7 | 7.0 | 118 | 433 | |
| | | 16:23 | 2.4 | 32.46 | 7.96 | 53,774 | 35.6 | 7.5 | 125 | 434 | |
| M-8 | 7/27/20 | 10:12 | 0.5 | 30.30 | 8.16 | 49,466 | 32.4 | 6.7 | 107 | 450 | 1.52 |
| | | 10:13 | 1.0 | 30.22 | 8.14 | 49,460 | 32.4 | 6.7 | 106 | 450 | |
| | | 10:14 | 2.0 | 30.31 | 8.08 | 50,103 | 32.9 | 5.4 | 85 | 447 | |
| | | 10:15 | 2.8 | 30.39 | 8.04 | 50,523 | 33.2 | 4.4 | 70 | 436 | |
| M-8 | 8/31/20 | 16:39 | 0.5 | 32.97 | 8.10 | 51,224 | 33.7 | 6.1 | 101 | 424 | 1.33 |
| | | 16:40 | 1.0 | 32.94 | 8.08 | 51,318 | 33.8 | 5.6 | 94 | 422 | |
| | | 16:41 | 2.0 | 32.14 | 8.04 | 51,546 | 34.0 | 4.9 | 81 | 420 | |
| | | 16:41 | 2.6 | 32.10 | 8.03 | 51,696 | 34.1 | 4.9 | 81 | 378 | |
| M-8 | 9/23/20 | 14:17 | 0.5 | 30.62 | 8.16 | 45,757 | 29.6 | 6.1 | 96 | 450 | 1.14 |
| | | 14:18 | 1.0 | 29.81 | 8.21 | 47,002 | 30.6 | 5.7 | 89 | 451 | |
| | | 14:19 | 2.0 | 29.62 | 8.25 | 48,332 | 31.6 | 7.2 | 113 | 452 | |
| | | 14:19 | 2.4 | 29.51 | 7.84 | 49,252 | 32.3 | 5.8 | 92 | 348 | |

Vertical Profiles Collected in Marco Island Surface Waters from April - September 2020

| Site | Date | Time | Depth (m) | Temp. (°C) | pH (s.u.) | Cond. (µmho/cm) | Salinity (ppt) | Diss. O ₂ (mg/L) | Diss. O ₂ (% Sat.) | ORP (mV) | Secchi (m) |
|------|---------|-------|-----------|------------|-----------|-----------------|----------------|-----------------------------|-------------------------------|----------|------------|
| M-9 | 5/5/20 | 9:20 | 0.5 | 28.08 | 7.77 | 55,400 | 36.8 | 5.7 | 90 | 440 | 1.46 |
| | | 9:20 | 1.0 | 27.92 | 7.79 | 55,624 | 37.0 | 5.7 | 90 | 441 | |
| | | 9:21 | 2.0 | 27.92 | 7.79 | 55,607 | 37.0 | 5.7 | 90 | 441 | |
| | | 9:22 | 3.0 | 27.88 | 7.79 | 55,631 | 37.0 | 5.7 | 89 | 442 | |
| | | 9:22 | 4.0 | 27.87 | 7.79 | 55,612 | 37.0 | 5.6 | 89 | 442 | |
| | | 9:23 | 5.0 | 27.88 | 7.79 | 55,779 | 37.1 | 5.7 | 90 | 442 | |
| | | 9:23 | 6.0 | 27.85 | 7.80 | 55,797 | 37.1 | 5.7 | 90 | 443 | |
| | | 9:24 | 6.9 | 27.83 | 7.80 | 55,781 | 37.1 | 5.7 | 89 | 443 | |
| M-9 | 5/26/20 | 18:42 | 0.5 | 30.45 | 7.96 | 54,622 | 36.2 | 10.1 | 165 | 439 | 0.88 |
| | | 18:42 | 1.0 | 30.05 | 7.95 | 54,609 | 36.2 | 10.1 | 163 | 439 | |
| | | 18:43 | 2.0 | 28.86 | 7.82 | 55,239 | 36.7 | 7.3 | 117 | 436 | |
| | | 18:44 | 3.0 | 28.49 | 7.79 | 55,516 | 36.9 | 6.8 | 107 | 436 | |
| | | 18:46 | 4.0 | 28.18 | 7.73 | 55,720 | 37.1 | 5.6 | 88 | 435 | |
| | | 18:47 | 4.6 | 28.15 | 7.72 | 55,742 | 37.1 | 5.5 | 87 | 436 | |
| M-9 | 6/29/20 | 16:53 | 0.5 | 33.68 | 7.96 | 52,328 | 34.5 | 7.1 | 121 | 416 | 1.32 |
| | | 16:54 | 1.0 | 33.50 | 7.94 | 52,555 | 34.7 | 7.1 | 120 | 417 | |
| | | 16:54 | 2.0 | 33.01 | 7.90 | 52,985 | 35.0 | 6.6 | 110 | 416 | |
| | | 16:55 | 3.0 | 32.75 | 7.87 | 53,095 | 35.1 | 6.1 | 101 | 417 | |
| | | 16:56 | 3.8 | 32.74 | 7.86 | 53,124 | 35.1 | 5.9 | 99 | 418 | |
| M-9 | 7/27/20 | 10:42 | 0.5 | 30.54 | 8.14 | 46,490 | 30.3 | 6.5 | 103 | 450 | 1.47 |
| | | 10:42 | 1.0 | 30.41 | 8.12 | 46,741 | 30.4 | 6.5 | 103 | 449 | |
| | | 10:43 | 2.0 | 30.50 | 8.08 | 47,676 | 31.1 | 5.5 | 87 | 449 | |
| | | 10:43 | 3.0 | 30.43 | 8.06 | 48,339 | 31.6 | 5.3 | 85 | 448 | |
| | | 10:44 | 4.0 | 30.34 | 8.06 | 48,800 | 31.9 | 5.3 | 83 | 448 | |
| | | 10:44 | 5.0 | 30.21 | 8.06 | 49,130 | 32.2 | 5.2 | 82 | 448 | |
| | | 10:45 | 5.7 | 30.19 | 8.05 | 49,338 | 32.3 | 4.9 | 78 | 443 | |
| M-9 | 8/31/20 | 17:20 | 0.5 | 32.82 | 8.09 | 50,061 | 32.9 | 6.5 | 108 | 416 | 1.17 |
| | | 17:21 | 1.0 | 32.73 | 8.08 | 50,150 | 32.9 | 6.2 | 102 | 416 | |
| | | 17:22 | 2.0 | 32.39 | 8.03 | 50,452 | 33.1 | 5.3 | 87 | 414 | |
| | | 17:22 | 3.0 | 32.17 | 7.99 | 50,775 | 33.4 | 4.6 | 76 | 412 | |
| | | 17:23 | 4.0 | 32.06 | 7.97 | 50,966 | 33.5 | 4.4 | 72 | 412 | |
| | | 17:23 | 4.8 | 32.03 | 7.97 | 51,036 | 33.6 | 4.2 | 70 | 411 | |
| M-9 | 9/23/20 | 14:51 | 0.5 | 30.38 | 8.27 | 39,519 | 25.2 | 7.7 | 118 | 469 | 1.62 |
| | | 14:52 | 1.0 | 29.98 | 8.25 | 40,429 | 25.9 | 7.4 | 114 | 465 | |
| | | 14:52 | 2.0 | 29.39 | 8.18 | 43,745 | 28.3 | 6.4 | 99 | 460 | |
| | | 14:53 | 3.0 | 29.17 | 8.16 | 44,545 | 28.8 | 5.8 | 90 | 457 | |
| | | 14:53 | 4.0 | 28.99 | 8.14 | 45,480 | 29.5 | 5.3 | 82 | 455 | |
| | | 14:54 | 5.0 | 28.97 | 8.13 | 45,619 | 29.6 | 5.1 | 78 | 454 | |
| | | 14:54 | 6.0 | 28.97 | 8.14 | 45,619 | 29.6 | 5.0 | 77 | 451 | |
| | | 14:55 | 6.3 | 28.97 | 8.14 | 45,652 | 29.6 | 5.1 | 79 | 451 | |

Vertical Profiles Collected in Marco Island Surface Waters from April - September 2020

| Site | Date | Time | Depth (m) | Temp. (°C) | pH (s.u.) | Cond. (µmho/cm) | Salinity (ppt) | Diss. O ₂ (mg/L) | Diss. O ₂ (% Sat.) | ORP (mV) | Secchi (m) |
|------|---------|-------|-----------|------------|-----------|-----------------|----------------|-----------------------------|-------------------------------|----------|------------|
| M-10 | 4/29/20 | 16:30 | 0.5 | 29.03 | 7.84 | 56,307 | 37.5 | 8.6 | 139 | 386 | 0.86 |
| | | 16:31 | 1.0 | 29.03 | 7.83 | 56,312 | 37.5 | 8.6 | 139 | 385 | |
| | | 16:32 | 2.0 | 28.69 | 7.79 | 56,350 | 37.5 | 8.1 | 129 | 384 | |
| | | 16:32 | 3.0 | 27.68 | 7.73 | 56,555 | 37.7 | 6.3 | 100 | 382 | |
| | | 16:33 | 4.0 | 27.64 | 7.72 | 56,581 | 37.7 | 6.1 | 97 | 382 | |
| | | 16:34 | 4.1 | 27.67 | 7.71 | 56,559 | 37.7 | 1.5 | 24 | 381 | |
| M-10 | 5/27/20 | 8:12 | 0.5 | 29.17 | 7.68 | 54,113 | 35.9 | 6.8 | 108 | 481 | 1.54 |
| | | 8:12 | 1.0 | 29.16 | 7.68 | 54,293 | 36.0 | 6.6 | 105 | 480 | |
| | | 8:13 | 2.0 | 29.05 | 7.65 | 54,533 | 36.2 | 5.9 | 94 | 478 | |
| | | 8:13 | 3.0 | 29.02 | 7.67 | 54,772 | 36.4 | 5.7 | 91 | 477 | |
| | | 8:14 | 4.0 | 29.00 | 7.65 | 44,802 | 29.0 | 5.8 | 89 | 475 | |
| | | 8:15 | 4.1 | 28.98 | 7.63 | 43,137 | 27.8 | 5.3 | 81 | 473 | |
| M-10 | 6/29/20 | 14:03 | 0.5 | 33.51 | 7.77 | 51,178 | 33.7 | 6.0 | 100 | 432 | 2.08 |
| | | 14:03 | 1.0 | 33.52 | 7.78 | 51,070 | 33.6 | 6.1 | 103 | 433 | |
| | | 14:04 | 2.0 | 32.90 | 7.76 | 51,737 | 34.1 | 5.6 | 93 | 434 | |
| | | 14:05 | 3.0 | 32.68 | 7.70 | 52,214 | 34.5 | 4.3 | 71 | 433 | |
| | | 14:05 | 4.0 | 32.63 | 7.72 | 52,371 | 34.6 | 4.8 | 79 | 434 | |
| M-10 | 7/27/20 | 9:00 | 0.5 | 30.51 | 8.13 | 46,640 | 30.4 | 6.4 | 100 | 446 | 1.92 |
| | | 9:00 | 1.0 | 30.55 | 8.14 | 46,995 | 30.6 | 6.4 | 101 | 447 | |
| | | 9:01 | 2.0 | 30.64 | 8.08 | 48,398 | 31.7 | 5.5 | 87 | 448 | |
| | | 9:01 | 3.0 | 30.59 | 8.06 | 48,651 | 31.8 | 5.2 | 83 | 447 | |
| | | 9:02 | 4.0 | 30.62 | 8.03 | 49,061 | 32.1 | 4.7 | 74 | 448 | |
| | | 9:03 | 4.2 | 30.69 | 7.99 | 49,198 | 32.2 | 4.1 | 66 | 443 | |
| M-10 | 8/31/20 | 14:33 | 0.5 | 33.03 | 8.25 | 49,620 | 32.5 | 9.2 | 153 | 426 | 1.27 |
| | | 14:33 | 1.0 | 32.83 | 8.26 | 49,895 | 32.7 | 9.0 | 148 | 426 | |
| | | 14:34 | 2.0 | 32.48 | 8.12 | 50,408 | 33.1 | 6.8 | 112 | 421 | |
| | | 14:35 | 3.0 | 32.22 | 8.04 | 50,729 | 33.4 | 5.2 | 86 | 419 | |
| | | 14:36 | 4.0 | 32.14 | 8.02 | 50,919 | 33.5 | 4.8 | 78 | 415 | |
| M-10 | 9/23/20 | 12:40 | 0.5 | 30.24 | 8.12 | 41,558 | 26.7 | 7.2 | 111 | 506 | 1.22 |
| | | 12:41 | 1.0 | 30.14 | 8.14 | 41,265 | 26.5 | 7.2 | 111 | 499 | |
| | | 12:42 | 2.0 | 29.99 | 8.02 | 42,341 | 27.3 | 6.4 | 99 | 492 | |
| | | 12:42 | 3.0 | 29.78 | 8.02 | 43,609 | 28.2 | 5.4 | 83 | 492 | |
| | | 12:44 | 3.6 | 29.86 | 8.05 | 41,356 | 26.5 | 0.0 | 0 | 181 | |

Vertical Profiles Collected in Marco Island Surface Waters from April - September 2020

| Site | Date | Time | Depth (m) | Temp. (°C) | pH (s.u.) | Cond. (µmho/cm) | Salinity (ppt) | Diss. O ₂ (mg/L) | Diss. O ₂ (% Sat.) | ORP (mV) | Secchi (m) |
|------|---------|-------|-----------|------------|-----------|-----------------|----------------|-----------------------------|-------------------------------|----------|------------|
| M-11 | 4/29/20 | 11:50 | 0.5 | 28.47 | 7.82 | 56,497 | 37.6 | 7.4 | 117 | 431 | 1.59 |
| | | 11:50 | 1.0 | 28.43 | 7.82 | 56,509 | 37.6 | 7.4 | 118 | 431 | |
| | | 11:51 | 2.0 | 28.34 | 7.81 | 56,491 | 37.6 | 7.1 | 113 | 431 | |
| | | 11:52 | 3.0 | 27.92 | 7.76 | 56,517 | 37.7 | 6.2 | 97 | 430 | |
| | | 11:53 | 4.0 | 27.91 | 7.73 | 56,542 | 37.7 | 5.8 | 91 | 429 | |
| | | 11:53 | 5.0 | 27.84 | 7.71 | 56,532 | 37.7 | 5.3 | 84 | 428 | |
| | | 11:54 | 6.0 | 27.78 | 7.70 | 56,575 | 37.7 | 5.1 | 81 | 428 | |
| | | 11:55 | 7.0 | 27.73 | 7.67 | 56,612 | 37.7 | 4.4 | 70 | 426 | |
| | | 11:56 | 7.6 | 27.69 | 7.59 | 47,815 | 31.2 | 2.8 | 43 | 135 | |
| M-11 | 5/27/20 | 17:14 | 0.5 | 30.26 | 7.96 | 54,766 | 36.4 | 7.6 | 123 | 387 | 2.31 |
| | | 17:15 | 1.0 | 29.94 | 7.93 | 54,697 | 36.3 | 7.2 | 117 | 388 | |
| | | 17:16 | 2.0 | 29.53 | 7.91 | 55,400 | 36.8 | 7.5 | 121 | 391 | |
| | | 17:16 | 3.0 | 29.01 | 7.88 | 55,896 | 37.2 | 7.0 | 112 | 392 | |
| | | 17:17 | 4.0 | 28.79 | 7.81 | 56,120 | 37.4 | 5.9 | 95 | 390 | |
| | | 17:17 | 5.0 | 28.44 | 7.72 | 56,274 | 37.5 | 4.4 | 70 | 387 | |
| | | 17:18 | 6.0 | 27.91 | 7.53 | 56,610 | 37.7 | 0.7 | 10 | 317 | |
| | | 17:20 | 7.0 | 27.38 | 7.56 | 56,787 | 37.9 | 0.0 | 0 | 59 | |
| | | 17:20 | 7.8 | 27.31 | 7.55 | 45,382 | 29.5 | 0.0 | 0 | 23 | |
| M-11 | 6/30/20 | 9:00 | 0.5 | 32.46 | 7.94 | 53,271 | 35.2 | 6.3 | 105 | 438 | 2.81 |
| | | 9:00 | 1.0 | 32.45 | 7.94 | 53,250 | 35.2 | 6.3 | 105 | 439 | |
| | | 9:01 | 2.0 | 32.69 | 7.93 | 53,502 | 35.4 | 6.2 | 104 | 439 | |
| | | 9:02 | 3.0 | 32.93 | 7.91 | 54,065 | 35.8 | 5.9 | 100 | 439 | |
| | | 9:02 | 4.0 | 32.68 | 7.86 | 54,091 | 35.8 | 5.1 | 85 | 437 | |
| | | 9:04 | 4.0 | 32.66 | 7.85 | 54,074 | 35.8 | 5.0 | 84 | 438 | |
| | | 9:05 | 5.0 | 32.24 | 7.72 | 53,976 | 35.8 | 2.9 | 47 | 433 | |
| | | 9:05 | 6.0 | 31.97 | 7.65 | 54,030 | 35.8 | 1.6 | 27 | 430 | |
| | | 9:07 | 7.0 | 29.80 | 7.50 | 54,305 | 36.0 | 0.0 | 0 | -21 | |
| | | 9:08 | 8.0 | 28.39 | 7.35 | 54,560 | 36.2 | 0.0 | 0 | -99 | |
| | | 9:08 | 8.6 | 28.15 | 7.33 | 45,436 | 29.5 | 0.0 | 0 | -124 | |
| M-11 | 7/28/20 | 10:22 | 0.5 | 31.14 | 8.40 | 47,258 | 30.8 | 8.4 | 134 | 429 | 1.84 |
| | | 10:23 | 1.0 | 32.14 | 8.33 | 49,400 | 32.4 | 8.7 | 143 | 428 | |
| | | 10:24 | 2.0 | 31.50 | 8.29 | 49,983 | 32.8 | 8.1 | 131 | 427 | |
| | | 10:24 | 3.0 | 30.97 | 8.23 | 50,398 | 33.1 | 6.8 | 110 | 425 | |
| | | 10:25 | 4.0 | 30.87 | 8.13 | 50,772 | 33.4 | 4.7 | 76 | 423 | |
| | | 10:26 | 5.0 | 30.85 | 7.95 | 50,945 | 33.5 | 1.5 | 25 | 416 | |
| | | 10:27 | 6.0 | 30.85 | 7.86 | 51,963 | 34.3 | 0.0 | 0 | 397 | |
| | | 10:27 | 7.0 | 30.40 | 7.74 | 52,801 | 34.9 | 0.0 | 0 | -22 | |
| | | 10:28 | 8.0 | 29.84 | 7.57 | 53,216 | 35.2 | 0.0 | 0 | -64 | |
| | | 10:28 | 8.2 | 29.63 | 7.53 | 45,247 | 29.4 | 0.0 | 0 | -84 | |
| M-11 | 9/1/20 | 13:22 | 0.5 | 32.97 | 8.34 | 51,061 | 33.6 | 7.8 | 130 | 391 | 2.61 |
| | | 13:22 | 1.0 | 32.69 | 8.37 | 51,131 | 33.7 | 8.7 | 144 | 394 | |
| | | 13:23 | 2.0 | 32.23 | 8.36 | 51,044 | 33.6 | 8.4 | 139 | 397 | |
| | | 13:23 | 3.0 | 32.11 | 8.33 | 51,147 | 33.7 | 7.8 | 128 | 397 | |
| | | 13:24 | 4.0 | 32.29 | 8.20 | 51,407 | 33.9 | 5.8 | 96 | 392 | |
| | | 13:24 | 5.0 | 32.45 | 8.07 | 52,145 | 34.4 | 2.7 | 44 | 384 | |
| | | 13:25 | 6.0 | 32.13 | 7.64 | 53,406 | 35.3 | 0.0 | 0 | 359 | |
| | | 13:26 | 7.0 | 30.97 | 7.22 | 54,844 | 36.4 | 0.0 | 0 | -58 | |
| | | 13:26 | 8.0 | 29.73 | 7.24 | 55,384 | 36.8 | 0.0 | 0 | -98 | |
| | | 13:27 | 8.3 | 29.61 | 7.29 | 44,879 | 29.1 | 0.0 | 0 | -110 | |
| M-11 | 9/24/20 | 12:56 | 0.5 | 29.41 | 8.36 | 45,445 | 29.5 | 7.7 | 119 | 376 | 1.73 |
| | | 12:57 | 1.0 | 29.42 | 8.35 | 45,501 | 29.5 | 7.7 | 119 | 379 | |
| | | 12:57 | 2.0 | 30.50 | 8.18 | 47,240 | 30.8 | 4.9 | 77 | 372 | |
| | | 12:58 | 3.0 | 30.82 | 7.75 | 48,484 | 31.7 | 0.0 | 0 | 346 | |
| | | 12:59 | 4.0 | 30.68 | 7.75 | 49,382 | 32.4 | 0.0 | 0 | 164 | |
| | | 13:00 | 5.0 | 29.79 | 7.99 | 49,264 | 32.3 | 1.5 | 24 | 235 | |
| | | 13:01 | 6.0 | 30.52 | 7.49 | 50,043 | 32.9 | 0.0 | 0 | -33 | |
| | | 13:01 | 7.0 | 30.10 | 7.20 | 51,026 | 33.6 | 0.0 | 0 | -89 | |
| | | 13:01 | 7.7 | 29.99 | 7.19 | 51,181 | 33.7 | 0.0 | 0 | -103 | |

Vertical Profiles Collected in Marco Island Surface Waters from April - September 2020

| Site | Date | Time | Depth (m) | Temp. (°C) | pH (s.u.) | Cond. (µmho/cm) | Salinity (ppt) | Diss. O ₂ (mg/L) | Diss. O ₂ (% Sat.) | ORP (mV) | Secchi (m) |
|------|---------|-------|-----------|------------|-----------|-----------------|----------------|-----------------------------|-------------------------------|----------|------------|
| M-12 | 5/5/20 | 9:53 | 0.5 | 28.62 | 7.75 | 54,301 | 36.0 | 6.6 | 105 | 433 | 1.89 |
| | | 9:53 | 1.0 | 28.11 | 7.73 | 54,552 | 36.2 | 6.2 | 98 | 432 | |
| | | 9:54 | 2.0 | 28.01 | 7.75 | 54,924 | 36.5 | 5.6 | 88 | 435 | |
| | | 9:55 | 3.0 | 27.85 | 7.71 | 55,049 | 36.6 | 5.0 | 79 | 433 | |
| | | 9:55 | 3.6 | 27.80 | 7.69 | 54,988 | 36.5 | 4.6 | 73 | 432 | |
| M-12 | 5/26/20 | 19:19 | 0.5 | 30.32 | 7.93 | 54,734 | 36.3 | 9.9 | 161 | 449 | 0.89 |
| | | 19:19 | 1.0 | 29.34 | 7.87 | 54,864 | 36.4 | 8.7 | 139 | 447 | |
| | | 19:20 | 2.0 | 28.52 | 7.76 | 55,333 | 36.8 | 6.4 | 101 | 444 | |
| | | 19:21 | 2.8 | 28.36 | 7.42 | 55,101 | 36.6 | 4.3 | 68 | 187 | |
| M-12 | 6/29/20 | 17:17 | 0.5 | 34.29 | 8.15 | 51,710 | 34.1 | 10.7 | 181 | 431 | 2.08 |
| | | 17:17 | 1.0 | 33.71 | 8.05 | 51,896 | 34.2 | 8.9 | 150 | 429 | |
| | | 17:18 | 2.0 | 32.79 | 7.87 | 52,897 | 35.0 | 5.8 | 97 | 422 | |
| | | 17:19 | 2.2 | 32.74 | 7.91 | 52,875 | 34.9 | 5.5 | 91 | 353 | |
| M-12 | 7/27/20 | 11:02 | 0.5 | 31.00 | 8.18 | 46,235 | 30.1 | 7.3 | 117 | 453 | 1.67 |
| | | 11:02 | 1.0 | 31.26 | 8.17 | 46,843 | 30.5 | 7.1 | 113 | 454 | |
| | | 11:03 | 2.0 | 30.60 | 8.05 | 47,812 | 31.2 | 5.1 | 80 | 450 | |
| | | 11:04 | 3.0 | 30.39 | 7.90 | 48,011 | 31.4 | 2.3 | 37 | 444 | |
| | | 11:04 | 3.2 | 30.41 | 7.89 | 48,065 | 31.4 | 2.0 | 31 | 390 | |
| M-12 | 8/31/20 | 17:39 | 0.5 | 32.70 | 8.10 | 49,915 | 32.8 | 6.7 | 111 | 419 | 1.48 |
| | | 17:39 | 1.0 | 32.64 | 8.10 | 50,116 | 32.9 | 6.7 | 111 | 419 | |
| | | 17:40 | 2.0 | 32.39 | 8.02 | 50,508 | 33.2 | 5.3 | 88 | 415 | |
| | | 17:41 | 3.0 | 32.19 | 7.72 | 50,753 | 33.4 | 4.3 | 70 | 142 | |
| M-12 | 9/23/20 | 15:08 | 0.5 | 30.31 | 8.27 | 38,954 | 24.8 | 8.0 | 122 | 466 | 0.92 |
| | | 15:09 | 1.0 | 30.29 | 8.34 | 39,764 | 25.4 | 9.1 | 139 | 468 | |
| | | 15:09 | 2.0 | 29.68 | 8.04 | 43,909 | 28.4 | 4.4 | 68 | 455 | |
| | | 15:11 | 3.0 | 29.53 | 8.17 | 28,339 | 17.4 | 4.9 | 70 | 221 | |

Vertical Profiles Collected in Marco Island Surface Waters from April - September 2020

| Site | Date | Time | Depth (m) | Temp. (°C) | pH (s.u.) | Cond. (µmho/cm) | Salinity (ppt) | Diss. O ₂ (mg/L) | Diss. O ₂ (% Sat.) | ORP (mV) | Secchi (m) |
|------|---------|-------|-----------|------------|-----------|-----------------|----------------|-----------------------------|-------------------------------|----------|------------|
| M-13 | 5/5/20 | 11:13 | 0.5 | 29.43 | 7.64 | 55,484 | 36.9 | 5.8 | 94 | 422 | 1.36 |
| | | 11:13 | 1.0 | 28.48 | 7.63 | 55,418 | 36.8 | 6.0 | 95 | 423 | |
| | | 11:14 | 2.0 | 27.95 | 7.64 | 55,638 | 37.0 | 5.4 | 86 | 423 | |
| | | 11:15 | 3.0 | 27.49 | 7.58 | 55,541 | 36.9 | 5.3 | 84 | 421 | |
| | | 11:16 | 3.8 | 27.30 | 7.39 | 55,916 | 37.2 | 1.6 | 24 | 370 | |
| M-13 | 5/27/20 | 9:41 | 0.5 | 28.64 | 7.59 | 55,864 | 37.2 | 5.8 | 91 | 467 | 0.84 |
| | | 9:41 | 1.0 | 28.71 | 7.59 | 55,822 | 37.1 | 5.4 | 86 | 467 | |
| | | 9:42 | 2.0 | 28.56 | 7.57 | 55,925 | 37.2 | 5.0 | 80 | 465 | |
| | | 9:42 | 3.0 | 28.49 | 7.51 | 55,952 | 37.2 | 4.1 | 65 | 463 | |
| | | 9:43 | 3.2 | 28.54 | 7.49 | 50,155 | 32.9 | 3.9 | 60 | 461 | |
| M-13 | 6/29/20 | 18:20 | 0.5 | 34.00 | 8.11 | 52,665 | 34.8 | 10.0 | 170 | 405 | 1.72 |
| | | 18:20 | 1.0 | 33.93 | 8.10 | 52,728 | 34.8 | 10.1 | 171 | 409 | |
| | | 18:21 | 2.0 | 32.61 | 7.92 | 53,498 | 35.4 | 6.9 | 115 | 403 | |
| | | 18:22 | 3.0 | 32.35 | 7.84 | 53,487 | 35.4 | 5.5 | 91 | 397 | |
| | | 18:22 | 3.3 | 32.25 | 7.66 | 42,592 | 27.4 | 2.6 | 41 | 336 | |
| M-13 | 7/27/20 | 12:02 | 0.5 | 31.17 | 8.18 | 45,951 | 29.9 | 7.5 | 120 | 431 | 1.36 |
| | | 12:03 | 1.0 | 31.18 | 8.17 | 46,375 | 30.2 | 7.6 | 120 | 432 | |
| | | 12:04 | 2.0 | 30.59 | 8.06 | 48,248 | 31.5 | 5.4 | 86 | 429 | |
| | | 12:06 | 2.9 | 30.53 | 7.92 | 50,093 | 32.9 | 0.0 | 0 | 34 | |
| M-13 | 8/31/20 | 18:32 | 0.5 | 32.28 | 8.11 | 50,476 | 33.2 | 6.4 | 105 | 376 | 1.33 |
| | | 18:33 | 1.0 | 32.17 | 8.06 | 50,544 | 33.2 | 5.6 | 92 | 377 | |
| | | 18:34 | 2.0 | 31.96 | 7.98 | 50,699 | 33.3 | 4.5 | 74 | 376 | |
| | | 18:34 | 3.0 | 31.85 | 7.88 | 50,940 | 33.5 | 3.1 | 50 | 359 | |
| | | 18:35 | 3.2 | 31.85 | 7.97 | 51,016 | 33.6 | 3.0 | 49 | 156 | |
| M-13 | 9/23/20 | 15:57 | 0.5 | 30.57 | 8.33 | 40,791 | 26.1 | 8.9 | 138 | 444 | 1.63 |
| | | 15:57 | 1.0 | 29.98 | 8.30 | 41,613 | 26.7 | 8.1 | 125 | 443 | |
| | | 15:58 | 2.0 | 29.47 | 8.17 | 43,754 | 28.3 | 6.1 | 94 | 438 | |
| | | 15:59 | 3.0 | 30.30 | 7.73 | 46,891 | 30.5 | 0.0 | 0 | 17 | |
| | | 16:00 | 3.3 | 30.57 | 7.38 | 47,103 | 30.7 | 0.0 | 0 | -50 | |

Vertical Profiles Collected in Marco Island Surface Waters from April - September 2020

| Site | Date | Time | Depth (m) | Temp. (°C) | pH (s.u.) | Cond. (µmho/cm) | Salinity (ppt) | Diss. O ₂ (mg/L) | Diss. O ₂ (% Sat.) | ORP (mV) | Secchi (m) |
|------|---------|-------|-----------|------------|-----------|-----------------|----------------|-----------------------------|-------------------------------|----------|------------|
| M-14 | 4/29/20 | 13:39 | 0.5 | 29.03 | 7.85 | 43,663 | 28.2 | 8.8 | 135 | 322 | 0.83 |
| | | 13:40 | 1.0 | 28.51 | 7.83 | 44,097 | 28.5 | 8.6 | 131 | 324 | |
| | | 13:41 | 2.0 | 28.31 | 7.82 | 44,135 | 28.5 | 8.3 | 126 | 325 | |
| | | 13:41 | 3.0 | 27.41 | 7.70 | 44,591 | 28.9 | 5.5 | 82 | 320 | |
| | | 13:42 | 4.0 | 27.41 | 7.68 | 44,374 | 28.7 | 4.7 | 70 | 318 | |
| | | 13:43 | 4.0 | 27.37 | 7.64 | 44,445 | 28.8 | 3.1 | 47 | 167 | |
| M-14 | 5/27/20 | 15:50 | 0.5 | 30.40 | 7.81 | 54,865 | 36.4 | 7.7 | 126 | 447 | 1.54 |
| | | 15:50 | 1.0 | 30.13 | 7.80 | 55,013 | 36.5 | 7.6 | 123 | 447 | |
| | | 15:51 | 2.0 | 29.44 | 7.76 | 55,589 | 37.0 | 6.4 | 103 | 446 | |
| | | 15:51 | 3.0 | 28.82 | 7.69 | 55,876 | 37.2 | 4.9 | 78 | 444 | |
| | | 15:52 | 3.9 | 28.79 | 7.49 | 55,728 | 37.1 | 1.9 | 30 | 431 | |
| M-14 | 6/30/20 | 10:09 | 0.5 | 32.86 | 7.99 | 53,030 | 35.1 | 6.2 | 104 | 379 | 1.61 |
| | | 10:09 | 1.0 | 32.84 | 7.99 | 53,046 | 35.1 | 6.4 | 106 | 381 | |
| | | 10:10 | 2.0 | 33.18 | 7.95 | 54,020 | 35.8 | 5.2 | 88 | 379 | |
| | | 10:11 | 3.0 | 32.80 | 7.90 | 54,168 | 35.9 | 3.8 | 64 | 274 | |
| | | 10:11 | 4.0 | 32.71 | 7.90 | 54,227 | 35.9 | 3.8 | 64 | 272 | |
| | | 10:12 | 4.2 | 32.70 | 7.80 | 43,126 | 27.8 | 3.8 | 60 | 112 | |
| M-14 | 7/28/20 | 8:57 | 0.5 | 30.45 | 8.05 | 48,483 | 31.7 | 6.3 | 100 | 464 | 1.84 |
| | | 8:57 | 1.0 | 31.55 | 8.09 | 50,162 | 32.9 | 5.9 | 96 | 463 | |
| | | 8:58 | 2.0 | 30.99 | 8.06 | 50,782 | 33.4 | 5.0 | 80 | 460 | |
| | | 8:59 | 3.0 | 30.63 | 8.02 | 51,346 | 33.8 | 3.9 | 62 | 457 | |
| | | 9:00 | 4.0 | 30.56 | 8.04 | 51,524 | 33.9 | 4.2 | 68 | 456 | |
| | | 9:01 | 4.2 | 30.57 | 8.05 | 51,516 | 33.9 | 4.2 | 68 | 444 | |
| M-14 | 9/1/20 | 12:15 | 0.5 | 32.77 | 8.12 | 51,335 | 33.8 | 5.4 | 89 | 410 | 2.31 |
| | | 12:16 | 1.0 | 32.26 | 8.18 | 51,298 | 33.8 | 6.3 | 103 | 412 | |
| | | 12:17 | 2.0 | 32.29 | 8.12 | 51,401 | 33.9 | 5.2 | 86 | 410 | |
| | | 12:17 | 3.0 | 32.09 | 8.14 | 51,569 | 34.0 | 5.4 | 88 | 411 | |
| | | 12:18 | 4.0 | 32.56 | 8.14 | 52,513 | 34.7 | 0.0 | 0 | 240 | |
| | | 12:19 | 4.2 | 32.57 | 7.85 | 39,132 | 25.0 | 0.0 | 0 | 37 | |
| M-14 | 9/24/20 | 12:00 | 0.5 | 29.67 | 8.24 | 46,762 | 30.5 | 7.2 | 113 | 440 | 1.38 |
| | | 12:00 | 1.0 | 30.14 | 8.18 | 48,021 | 31.4 | 6.2 | 99 | 437 | |
| | | 12:01 | 2.0 | 29.89 | 8.15 | 48,961 | 32.1 | 5.0 | 80 | 436 | |
| | | 12:02 | 3.0 | 29.52 | 8.13 | 49,415 | 32.4 | 4.5 | 70 | 436 | |
| | | 12:05 | 3.7 | 29.51 | 7.76 | 49,531 | 32.5 | 2.5 | 39 | -10 | |

Vertical Profiles Collected in Marco Island Surface Waters from April - September 2020

| Site | Date | Time | Depth (m) | Temp. (°C) | pH (s.u.) | Cond. (µmho/cm) | Salinity (ppt) | Diss. O ₂ (mg/L) | Diss. O ₂ (% Sat.) | ORP (mV) | Secchi (m) |
|-------|---------|-------|-----------|------------|-----------|-----------------|----------------|-----------------------------|-------------------------------|----------|------------|
| M-15 | 4/29/20 | 13:03 | 0.5 | 27.97 | 7.78 | 42,575 | 27.4 | 6.9 | 103 | 289 | 0.98 |
| | | 13:04 | 1.0 | 27.93 | 7.78 | 42,736 | 27.5 | 6.9 | 103 | 294 | |
| | | 13:05 | 2.0 | 27.73 | 7.78 | 43,011 | 27.7 | 6.8 | 102 | 298 | |
| | | 13:06 | 3.0 | 27.60 | 7.77 | 43,106 | 27.8 | 6.6 | 99 | 300 | |
| | | 13:06 | 4.0 | 27.52 | 7.76 | 43,170 | 27.8 | 6.5 | 97 | 301 | |
| | | 13:07 | 5.0 | 27.46 | 7.75 | 43,187 | 27.9 | 6.3 | 94 | 303 | |
| | | 13:07 | 5.2 | 27.47 | 7.74 | 43,161 | 27.8 | 6.2 | 91 | 303 | |
| M-15 | 5/27/20 | 16:15 | 0.5 | 30.27 | 7.79 | 55,619 | 37.0 | 6.3 | 102 | 437 | 1.39 |
| | | 16:16 | 1.0 | 29.80 | 7.79 | 55,835 | 37.1 | 6.2 | 100 | 438 | |
| | | 16:16 | 2.0 | 29.66 | 7.76 | 55,643 | 37.0 | 5.8 | 94 | 438 | |
| | | 16:17 | 3.0 | 29.42 | 7.76 | 55,795 | 37.1 | 5.7 | 92 | 439 | |
| | | 16:18 | 4.0 | 29.30 | 7.75 | 55,784 | 37.1 | 5.6 | 91 | 440 | |
| | | 16:19 | 5.0 | 29.23 | 7.74 | 55,802 | 37.1 | 5.5 | 87 | 440 | |
| | | 16:19 | 6.0 | 29.18 | 7.73 | 55,871 | 37.2 | 5.4 | 86 | 440 | |
| 16:20 | 6.6 | 29.12 | 7.73 | 55,914 | 37.2 | 5.3 | 85 | 440 | | | |
| M-15 | 6/30/20 | 9:54 | 0.5 | 32.85 | 7.97 | 53,480 | 35.4 | 5.5 | 93 | 401 | 2.11 |
| | | 9:55 | 1.0 | 32.78 | 7.97 | 53,673 | 35.5 | 5.5 | 91 | 400 | |
| | | 9:56 | 2.0 | 32.65 | 7.97 | 54,069 | 35.8 | 5.2 | 87 | 398 | |
| | | 9:57 | 3.0 | 32.57 | 7.97 | 54,225 | 35.9 | 5.1 | 85 | 397 | |
| | | 9:57 | 4.0 | 32.55 | 7.96 | 54,303 | 36.0 | 5.0 | 84 | 396 | |
| | | 9:58 | 5.0 | 32.54 | 7.95 | 54,315 | 36.0 | 4.8 | 80 | 396 | |
| | | 9:58 | 6.0 | 32.52 | 7.94 | 54,375 | 36.1 | 4.4 | 74 | 395 | |
| | | 9:59 | 7.0 | 32.51 | 7.93 | 54,414 | 36.1 | 4.3 | 72 | 394 | |
| 9:59 | 7.7 | 32.50 | 7.91 | 54,405 | 36.1 | 4.0 | 67 | 252 | | | |
| M-15 | 7/28/20 | 9:10 | 0.5 | 30.76 | 8.13 | 49,008 | 32.1 | 6.0 | 95 | 412 | 1.86 |
| | | 9:11 | 1.0 | 30.78 | 8.13 | 49,622 | 32.5 | 5.8 | 93 | 412 | |
| | | 9:11 | 2.0 | 30.46 | 8.16 | 50,600 | 33.3 | 5.6 | 90 | 412 | |
| | | 9:12 | 3.0 | 30.33 | 8.13 | 51,473 | 33.9 | 5.0 | 81 | 411 | |
| | | 9:13 | 4.0 | 30.31 | 8.12 | 51,797 | 34.2 | 4.7 | 76 | 409 | |
| | | 9:13 | 5.0 | 30.30 | 8.12 | 51,893 | 34.2 | 4.6 | 74 | 409 | |
| | | 9:14 | 5.6 | 30.30 | 8.11 | 51,911 | 34.2 | 4.6 | 74 | 408 | |
| M-15 | 9/1/20 | 12:30 | 0.5 | 32.31 | 8.14 | 51,619 | 34.0 | 4.7 | 78 | 352 | 1.11 |
| | | 12:30 | 1.0 | 32.17 | 8.14 | 51,634 | 34.0 | 4.7 | 77 | 355 | |
| | | 12:30 | 2.0 | 31.99 | 8.13 | 51,686 | 34.1 | 4.6 | 76 | 358 | |
| | | 12:31 | 3.0 | 31.83 | 8.12 | 51,844 | 34.2 | 4.4 | 73 | 359 | |
| | | 12:31 | 4.0 | 31.77 | 8.12 | 51,844 | 34.2 | 4.3 | 70 | 361 | |
| | | 12:32 | 5.0 | 31.76 | 8.12 | 51,922 | 34.2 | 4.3 | 71 | 363 | |
| | | 12:33 | 5.8 | 31.70 | 8.12 | 51,990 | 34.3 | 4.3 | 70 | 364 | |
| M-15 | 9/24/20 | 12:14 | 0.5 | 30.05 | 8.24 | 46,930 | 30.6 | 6.7 | 106 | 331 | 1.32 |
| | | 12:14 | 1.0 | 30.09 | 8.22 | 47,487 | 31.0 | 6.2 | 98 | 333 | |
| | | 12:15 | 2.0 | 29.73 | 8.19 | 49,023 | 32.1 | 5.0 | 80 | 334 | |
| | | 12:16 | 3.0 | 29.50 | 8.18 | 49,465 | 32.4 | 4.6 | 73 | 334 | |
| | | 12:16 | 4.0 | 29.48 | 8.18 | 49,524 | 32.5 | 4.7 | 74 | 335 | |
| | | 12:17 | 5.0 | 29.39 | 8.17 | 49,842 | 32.7 | 4.3 | 68 | 336 | |
| | | 12:17 | 5.2 | 29.40 | 8.17 | 49,846 | 32.7 | 4.3 | 67 | 336 | |

Vertical Profiles Collected in Marco Island Surface Waters from April - September 2020

| Site | Date | Time | Depth (m) | Temp. (°C) | pH (s.u.) | Cond. (µmho/cm) | Salinity (ppt) | Diss. O ₂ (mg/L) | Diss. O ₂ (% Sat.) | ORP (mV) | Secchi (m) |
|-------|---------|-------|-----------|------------|-----------|-----------------|----------------|-----------------------------|-------------------------------|----------|------------|
| M-16 | 4/29/20 | 11:17 | 0.5 | 27.19 | 7.69 | 56,840 | 37.9 | 6.2 | 97 | 478 | 1.14 |
| | | 11:18 | 1.0 | 27.18 | 7.69 | 56,854 | 37.9 | 6.2 | 97 | 477 | |
| | | 11:19 | 2.0 | 27.17 | 7.69 | 56,838 | 37.9 | 6.1 | 96 | 475 | |
| | | 11:20 | 3.0 | 27.20 | 7.70 | 56,809 | 37.9 | 6.2 | 97 | 475 | |
| | | 11:20 | 4.0 | 27.15 | 7.72 | 56,868 | 37.9 | 6.1 | 96 | 475 | |
| | | 11:22 | 5.0 | 27.15 | 7.72 | 56,864 | 37.9 | 6.2 | 97 | 473 | |
| | | 11:23 | 6.0 | 27.15 | 7.71 | 56,850 | 37.9 | 6.2 | 96 | 471 | |
| M-16 | 5/27/20 | 16:56 | 0.5 | 29.73 | 7.91 | 56,167 | 37.4 | 6.7 | 109 | 363 | 1.82 |
| | | 16:57 | 1.0 | 29.43 | 7.90 | 56,246 | 37.5 | 6.6 | 107 | 367 | |
| | | 16:57 | 2.0 | 29.20 | 7.89 | 56,281 | 37.5 | 6.5 | 105 | 370 | |
| | | 16:58 | 3.0 | 29.01 | 7.88 | 56,334 | 37.5 | 6.4 | 103 | 372 | |
| | | 16:58 | 4.0 | 28.99 | 7.88 | 56,356 | 37.5 | 6.3 | 101 | 373 | |
| | | 16:59 | 4.7 | 28.84 | 7.87 | 56,442 | 37.6 | 6.2 | 99 | 374 | |
| M-16 | 6/30/20 | 8:42 | 0.5 | 32.42 | 7.88 | 54,395 | 36.1 | 5.7 | 95 | 458 | 1.59 |
| | | 8:42 | 1.0 | 32.43 | 7.88 | 54,424 | 36.1 | 5.7 | 95 | 457 | |
| | | 8:43 | 2.0 | 32.20 | 7.86 | 54,644 | 36.3 | 5.4 | 91 | 455 | |
| | | 8:44 | 3.0 | 32.16 | 7.86 | 54,690 | 36.3 | 5.3 | 87 | 454 | |
| | | 8:44 | 3.3 | 32.15 | 7.86 | 54,701 | 36.3 | 5.3 | 88 | 454 | |
| M-16 | 7/28/20 | 10:00 | 0.5 | 30.88 | 8.28 | 48,127 | 31.5 | 7.1 | 113 | 419 | 1.39 |
| | | 10:00 | 1.0 | 30.84 | 8.26 | 48,714 | 31.9 | 6.9 | 110 | 418 | |
| | | 10:01 | 2.0 | 30.85 | 8.25 | 48,968 | 32.1 | 6.7 | 108 | 419 | |
| | | 10:01 | 3.0 | 30.70 | 8.22 | 49,399 | 32.4 | 6.3 | 101 | 418 | |
| | | 10:02 | 4.0 | 30.65 | 8.22 | 49,855 | 32.7 | 6.1 | 98 | 418 | |
| | | 10:03 | 5.0 | 30.61 | 8.21 | 50,137 | 32.9 | 5.9 | 95 | 418 | |
| | | 10:03 | 6.0 | 30.49 | 8.19 | 50,649 | 33.3 | 5.7 | 92 | 418 | |
| | | 10:04 | 7.0 | 30.46 | 8.18 | 50,725 | 33.4 | 5.7 | 91 | 417 | |
| | | 10:05 | 8.0 | 30.42 | 8.17 | 50,900 | 33.5 | 5.5 | 89 | 417 | |
| 10:06 | 8.4 | 30.42 | 8.18 | 50,872 | 33.5 | 5.5 | 88 | 416 | | | |
| M-16 | 9/1/20 | 13:04 | 0.5 | 32.13 | 8.16 | 51,670 | 34.1 | 5.4 | 89 | 362 | 1.54 |
| | | 13:04 | 1.0 | 32.06 | 8.15 | 51,898 | 34.2 | 5.3 | 87 | 368 | |
| | | 13:05 | 2.0 | 31.56 | 8.11 | 52,655 | 34.8 | 4.5 | 75 | 368 | |
| | | 13:06 | 3.0 | 31.44 | 8.09 | 53,309 | 35.3 | 4.2 | 69 | 369 | |
| | | 13:06 | 3.9 | 31.43 | 8.09 | 53,426 | 35.4 | 4.1 | 68 | 370 | |
| M-16 | 9/24/20 | 13:16 | 0.5 | 29.71 | 8.27 | 46,467 | 30.2 | 6.6 | 103 | 296 | 1.52 |
| | | 13:17 | 1.0 | 29.80 | 8.25 | 47,006 | 30.6 | 5.8 | 91 | 301 | |
| | | 13:18 | 2.0 | 29.76 | 8.23 | 47,414 | 30.9 | 5.4 | 86 | 300 | |
| | | 13:18 | 3.0 | 29.63 | 8.21 | 48,106 | 31.4 | 5.0 | 79 | 300 | |
| | | 13:19 | 4.0 | 29.55 | 8.19 | 48,711 | 31.9 | 4.5 | 71 | 300 | |
| | | 13:20 | 5.0 | 29.53 | 8.19 | 48,821 | 32.0 | 4.5 | 71 | 301 | |
| | | 13:20 | 5.3 | 29.52 | 8.18 | 48,862 | 32.0 | 4.5 | 70 | 301 | |

Vertical Profiles Collected in Marco Island Surface Waters from April - September 2020

| Site | Date | Time | Depth (m) | Temp. (°C) | pH (s.u.) | Cond. (µmho/cm) | Salinity (ppt) | Diss. O ₂ (mg/L) | Diss. O ₂ (% Sat.) | ORP (mV) | Secchi (m) |
|------|---------|-------|-----------|------------|-----------|-----------------|----------------|-----------------------------|-------------------------------|----------|------------|
| M-17 | 4/29/20 | 12:29 | 0.5 | 27.93 | 7.81 | 56,885 | 37.9 | 6.6 | 105 | 310 | 1.07 |
| | | 12:30 | 1.0 | 27.91 | 7.81 | 56,911 | 37.9 | 6.6 | 105 | 315 | |
| | | 12:31 | 2.0 | 27.80 | 7.80 | 56,940 | 38.0 | 6.7 | 105 | 317 | |
| | | 12:32 | 3.0 | 27.69 | 7.80 | 56,923 | 38.0 | 6.6 | 105 | 319 | |
| | | 12:33 | 4.0 | 26.96 | 7.77 | 56,930 | 38.0 | 6.0 | 93 | 320 | |
| | | 12:33 | 5.0 | 26.70 | 7.76 | 56,935 | 38.0 | 5.7 | 88 | 321 | |
| | | 12:34 | 6.0 | 26.62 | 7.75 | 56,943 | 38.0 | 5.5 | 86 | 322 | |
| | | 12:35 | 7.0 | 26.53 | 7.74 | 56,989 | 38.0 | 5.2 | 81 | 322 | |
| | | 12:35 | 7.2 | 26.56 | 7.74 | 42,977 | 27.7 | 4.8 | 70 | 322 | |
| M-17 | 5/27/20 | 16:27 | 0.5 | 29.94 | 7.80 | 56,035 | 37.3 | 6.7 | 109 | 449 | 1.36 |
| | | 16:27 | 1.0 | 29.71 | 7.80 | 56,033 | 37.3 | 6.7 | 108 | 450 | |
| | | 16:28 | 2.0 | 29.31 | 7.78 | 56,014 | 37.3 | 6.4 | 102 | 449 | |
| | | 16:29 | 3.0 | 28.96 | 7.78 | 56,105 | 37.3 | 6.3 | 100 | 450 | |
| | | 16:30 | 4.0 | 28.69 | 7.74 | 56,159 | 37.4 | 5.6 | 90 | 449 | |
| | | 16:30 | 5.0 | 28.42 | 7.70 | 56,181 | 37.4 | 4.8 | 76 | 447 | |
| | | 16:31 | 6.0 | 27.81 | 7.62 | 56,270 | 37.5 | 3.5 | 55 | 443 | |
| | | 16:33 | 7.0 | 27.83 | 7.44 | 49,217 | 32.3 | 0.0 | 0 | 104 | |
| M-17 | 6/30/20 | 9:43 | 0.5 | 0.00 | 8.04 | 54,258 | 35.9 | 6.2 | 103 | 394 | 1.42 |
| | | 9:44 | 1.0 | 32.62 | 8.04 | 54,227 | 35.9 | 6.1 | 102 | 394 | |
| | | 9:44 | 2.0 | 32.47 | 8.02 | 54,264 | 36.0 | 5.7 | 95 | 393 | |
| | | 9:45 | 3.0 | 32.56 | 7.98 | 54,486 | 36.1 | 5.0 | 84 | 390 | |
| | | 9:46 | 4.0 | 32.43 | 7.95 | 54,491 | 36.1 | 4.3 | 71 | 386 | |
| | | 9:46 | 5.0 | 32.23 | 7.89 | 54,521 | 36.2 | 3.1 | 52 | 380 | |
| | | 9:47 | 6.0 | 32.12 | 7.86 | 54,464 | 36.1 | 2.4 | 40 | 211 | |
| M-17 | 7/28/20 | 9:20 | 0.5 | 30.34 | 8.20 | 50,991 | 33.6 | 6.0 | 95 | 423 | 2.47 |
| | | 9:21 | 1.0 | 30.29 | 8.20 | 51,126 | 33.7 | 6.0 | 97 | 423 | |
| | | 9:21 | 2.0 | 30.13 | 8.20 | 51,324 | 33.8 | 5.9 | 94 | 422 | |
| | | 9:22 | 3.0 | 30.22 | 8.09 | 51,873 | 34.2 | 4.4 | 71 | 415 | |
| | | 9:22 | 4.0 | 30.04 | 8.04 | 51,726 | 34.1 | 3.5 | 55 | 411 | |
| | | 9:23 | 5.0 | 29.90 | 7.99 | 52,143 | 34.4 | 2.6 | 41 | 408 | |
| | | 9:24 | 5.7 | 29.78 | 7.94 | 51,761 | 34.1 | 1.9 | 30 | 406 | |
| M-17 | 9/1/20 | 12:39 | 0.5 | 32.32 | 8.15 | 51,592 | 34.0 | 5.0 | 83 | 371 | 1.11 |
| | | 12:40 | 1.0 | 32.03 | 8.15 | 51,651 | 34.0 | 5.1 | 85 | 374 | |
| | | 12:40 | 2.0 | 31.91 | 8.15 | 51,811 | 34.2 | 5.1 | 83 | 376 | |
| | | 12:41 | 3.0 | 31.77 | 8.12 | 51,875 | 34.2 | 4.5 | 75 | 375 | |
| | | 12:42 | 4.0 | 31.62 | 8.13 | 51,895 | 34.2 | 4.6 | 76 | 377 | |
| | | 12:42 | 5.0 | 31.39 | 8.06 | 52,156 | 34.4 | 3.0 | 48 | 361 | |
| | | 12:43 | 6.0 | 31.32 | 8.07 | 52,399 | 34.6 | 2.4 | 39 | 271 | |
| | | 12:43 | 7.0 | 31.29 | 8.04 | 52,478 | 34.7 | 1.1 | 18 | 202 | |
| | | 12:44 | 7.3 | 31.07 | 8.06 | 43,121 | 27.8 | 0.0 | 0 | 71 | |
| M-17 | 9/24/20 | 12:24 | 0.5 | 29.57 | 8.26 | 48,813 | 32.0 | 6.3 | 100 | 358 | 1.37 |
| | | 12:25 | 1.0 | 29.54 | 8.26 | 48,854 | 32.0 | 6.4 | 100 | 360 | |
| | | 12:25 | 2.0 | 29.53 | 8.26 | 48,866 | 32.0 | 6.4 | 100 | 362 | |
| | | 12:26 | 3.0 | 29.45 | 8.27 | 48,909 | 32.0 | 6.5 | 102 | 363 | |
| | | 12:26 | 4.0 | 29.31 | 8.24 | 49,112 | 32.1 | 3.9 | 56 | 361 | |
| | | 12:27 | 5.0 | 29.12 | 8.21 | 49,428 | 32.2 | 1.8 | 25 | 341 | |
| | | 12:27 | 6.0 | 29.09 | 8.19 | 49,667 | 32.2 | 0.9 | 12 | 195 | |
| | | 12:28 | 6.3 | 28.89 | 8.18 | 43,365 | 27.8 | 0.0 | 0 | 82 | |

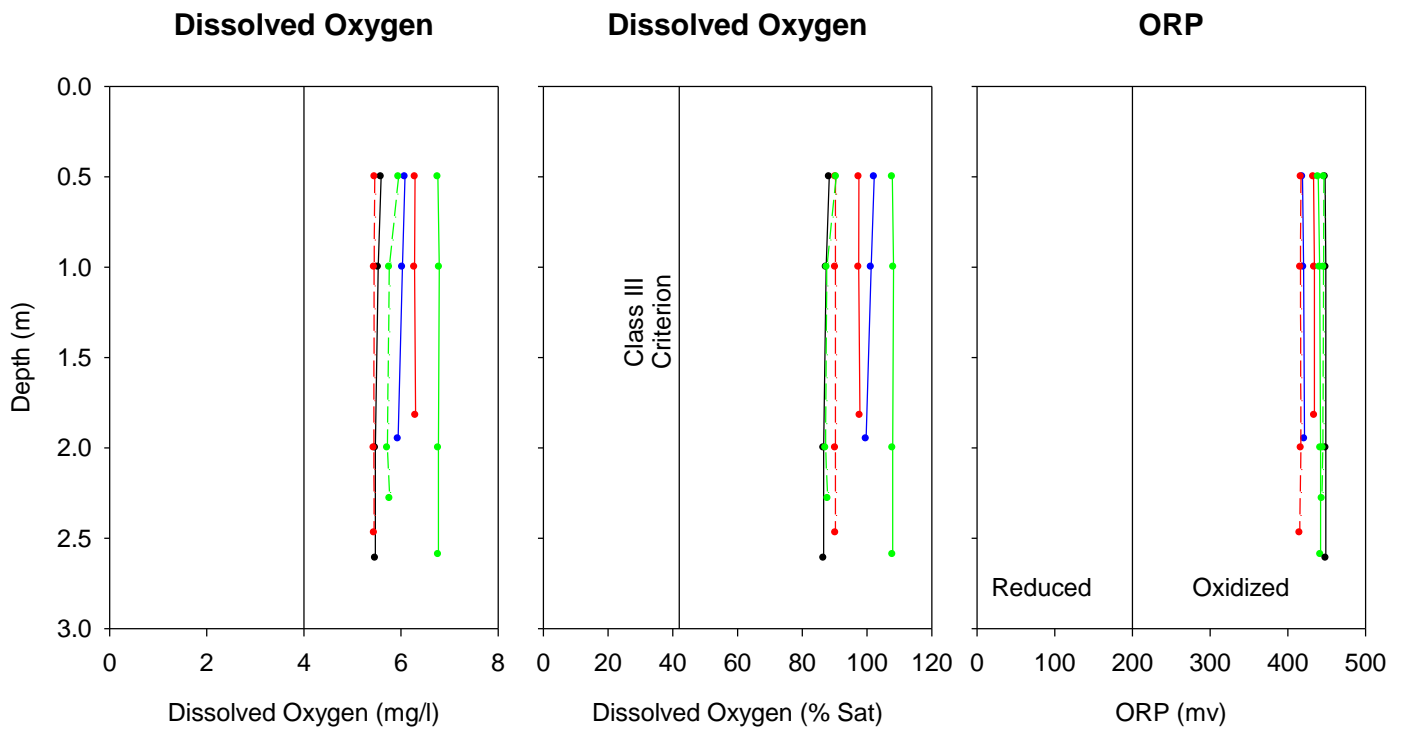
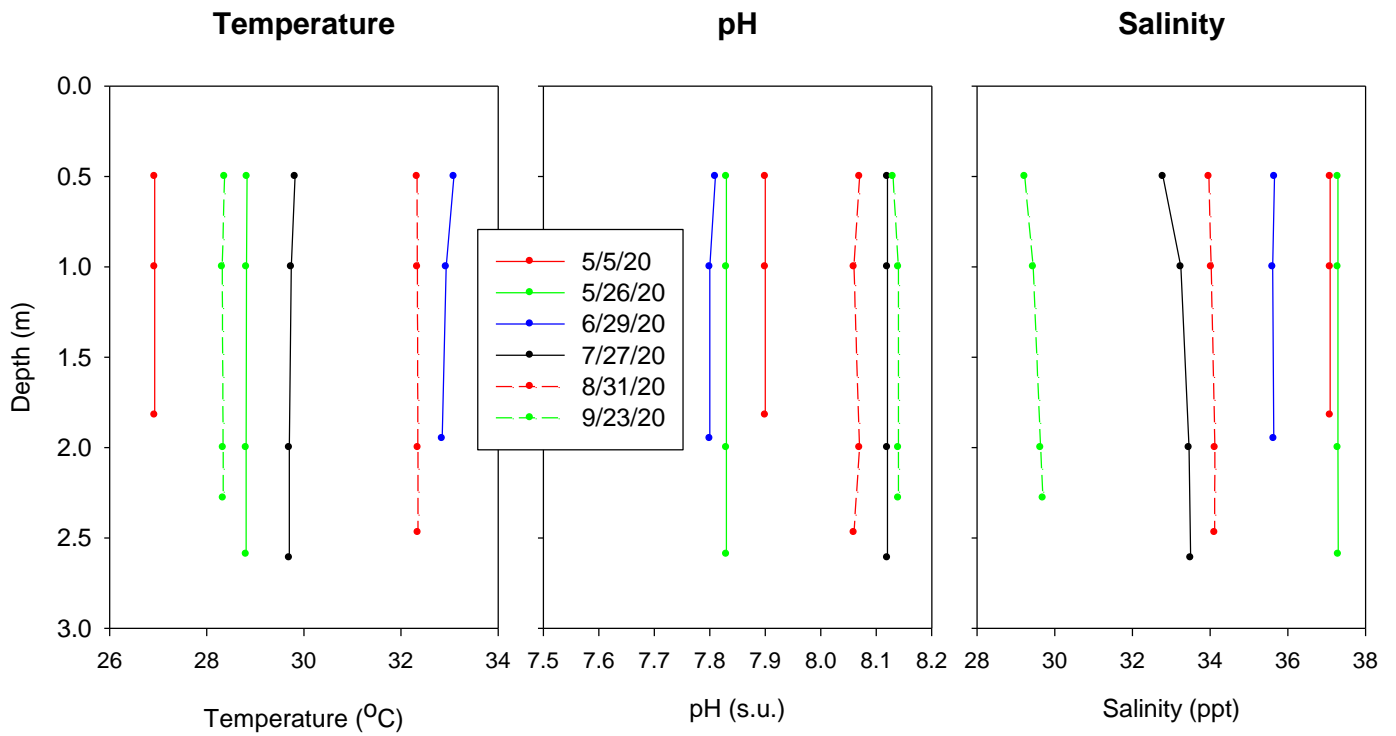

Vertical Field Profiles Collected in Marco Island at Site M-1.

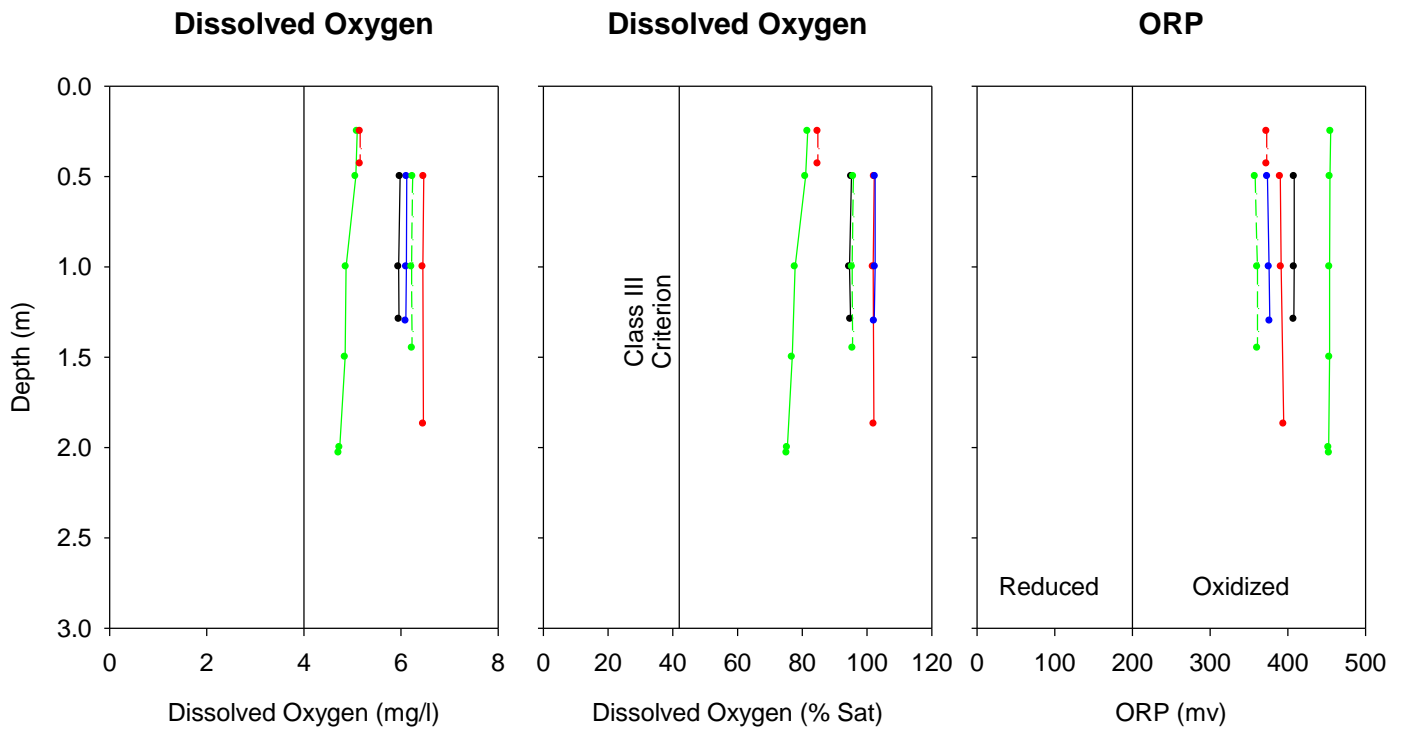
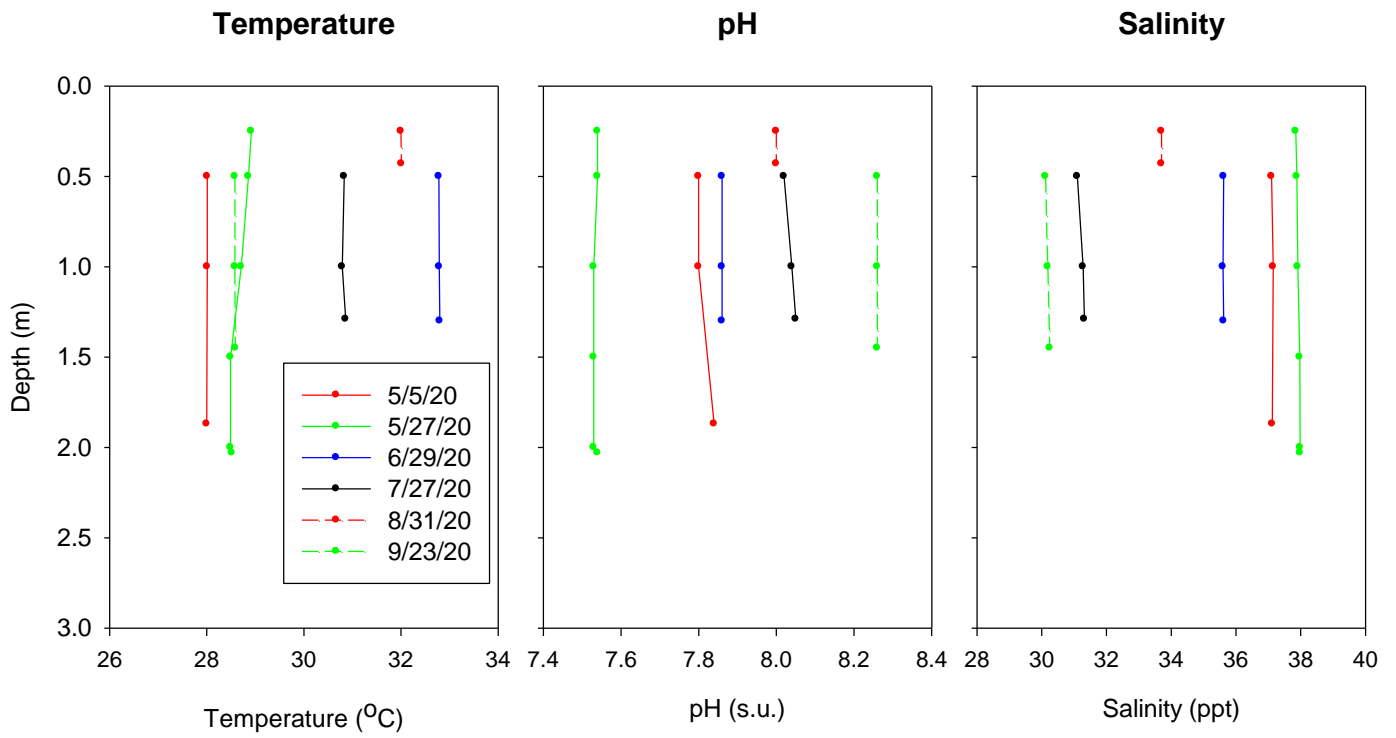

Vertical Field Profiles Collected in Marco Island at Site M-2.

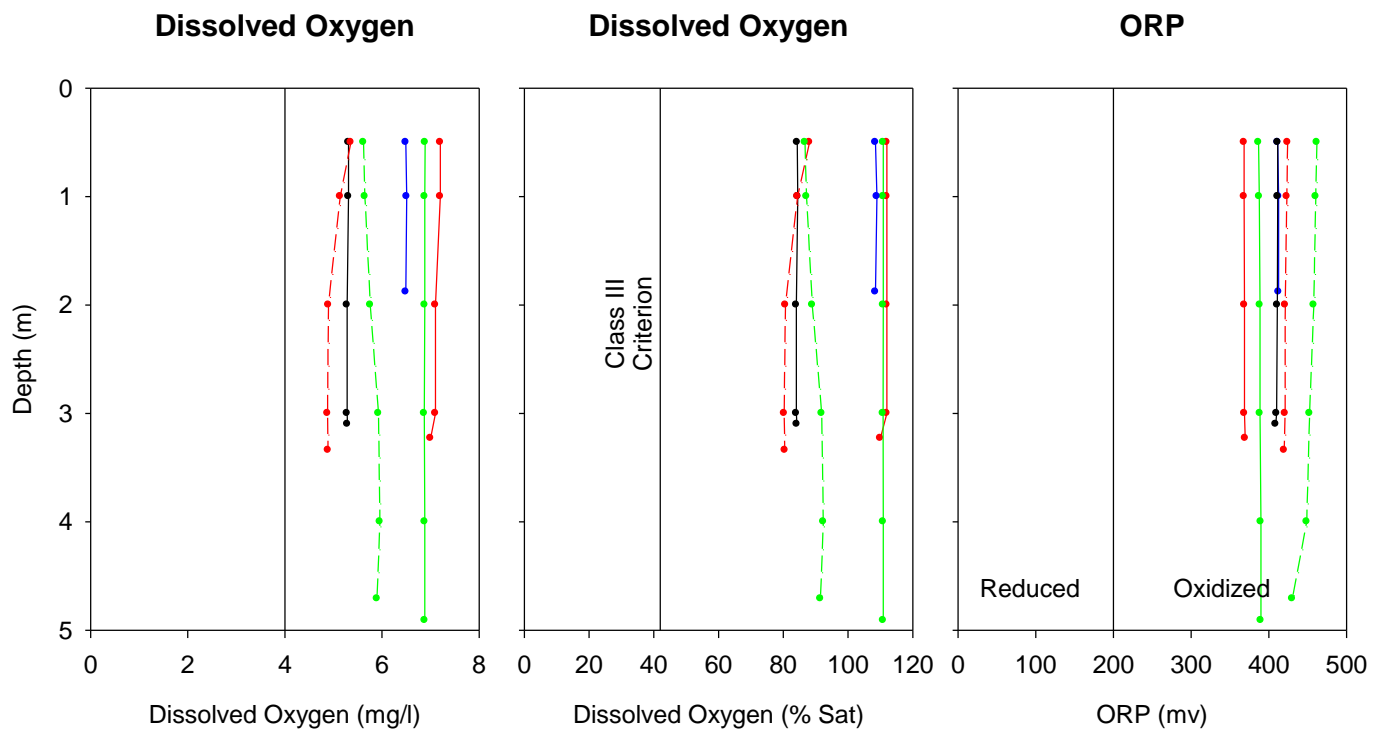
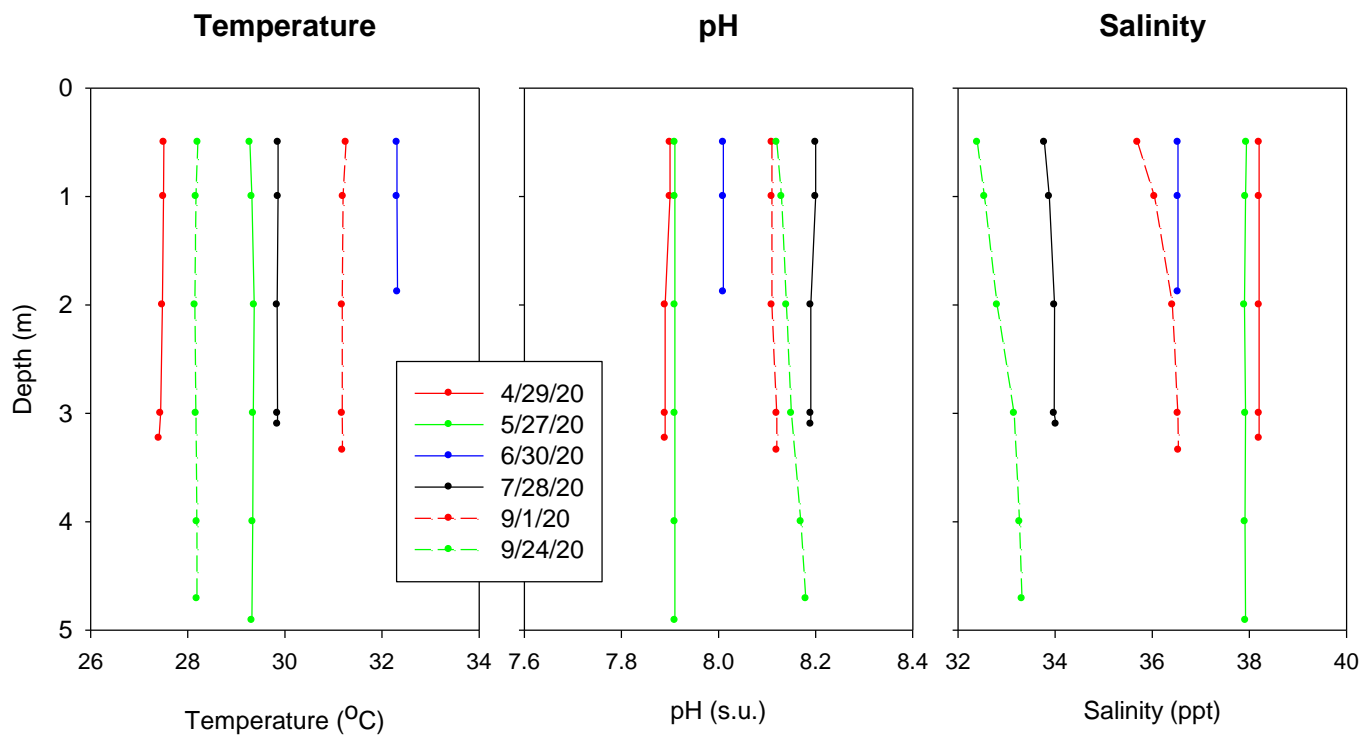

Vertical Field Profiles Collected in Marco Island at Site M-3.

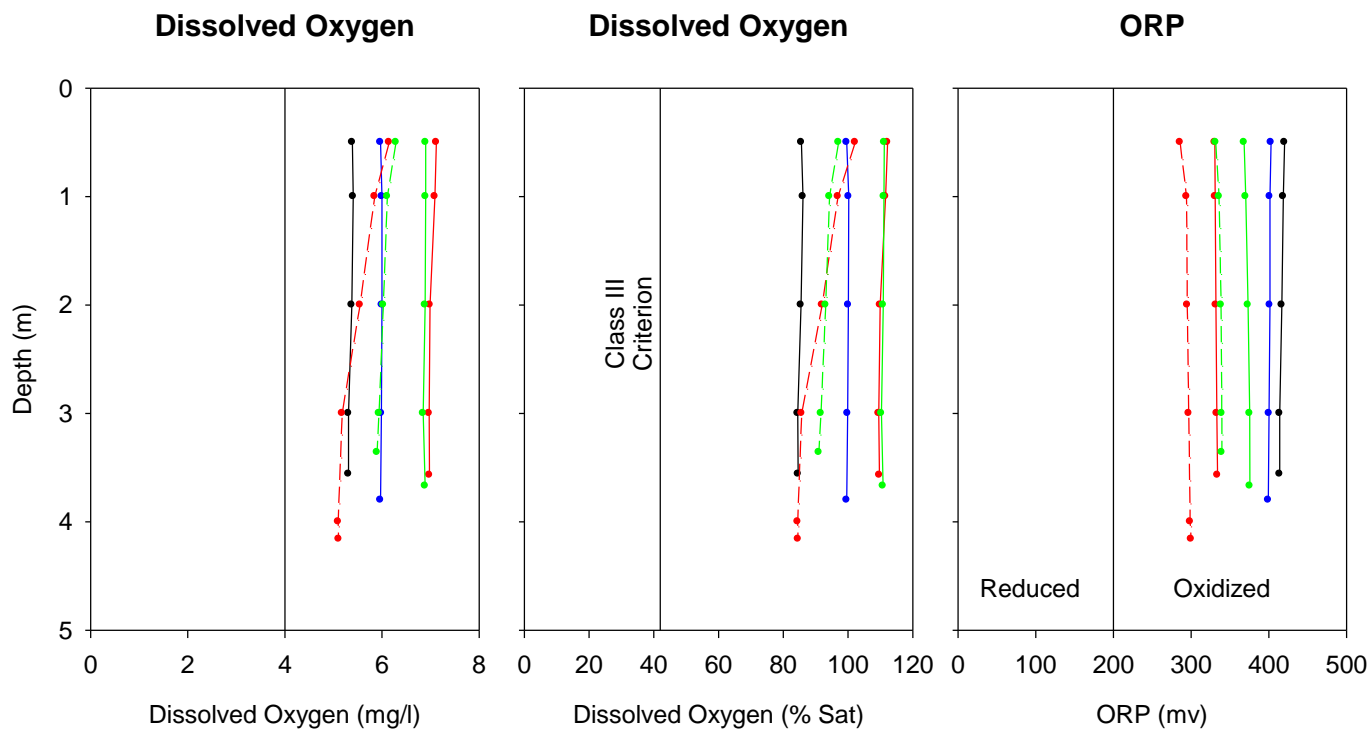
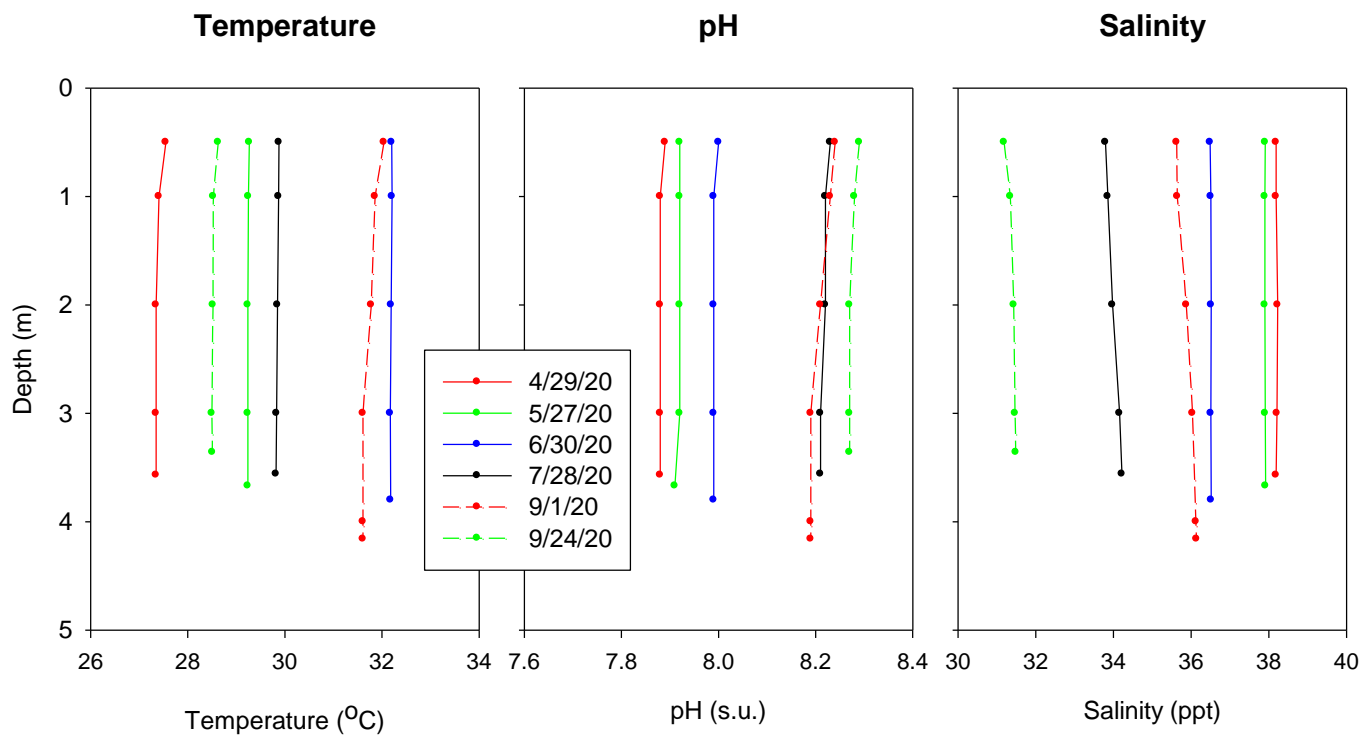

Vertical Field Profiles Collected in Marco Island at Site M-4.

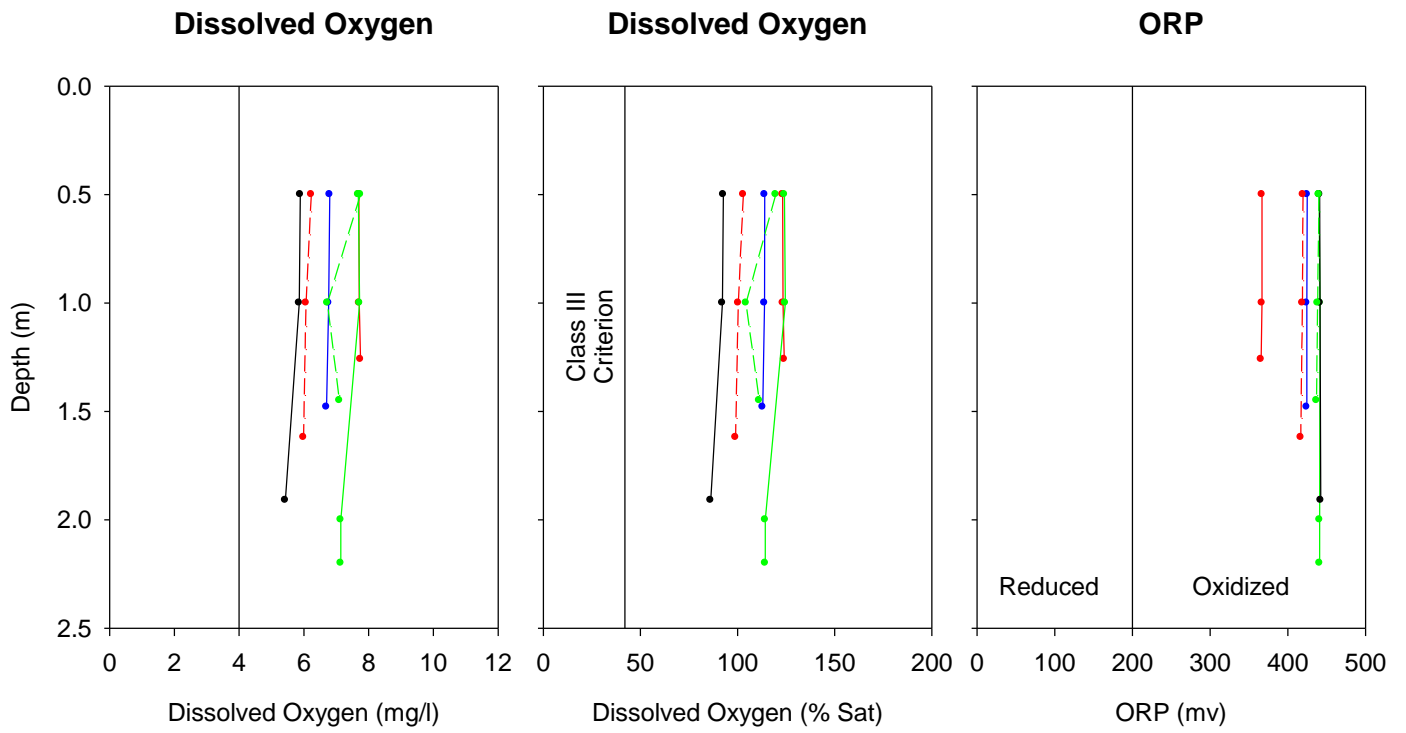
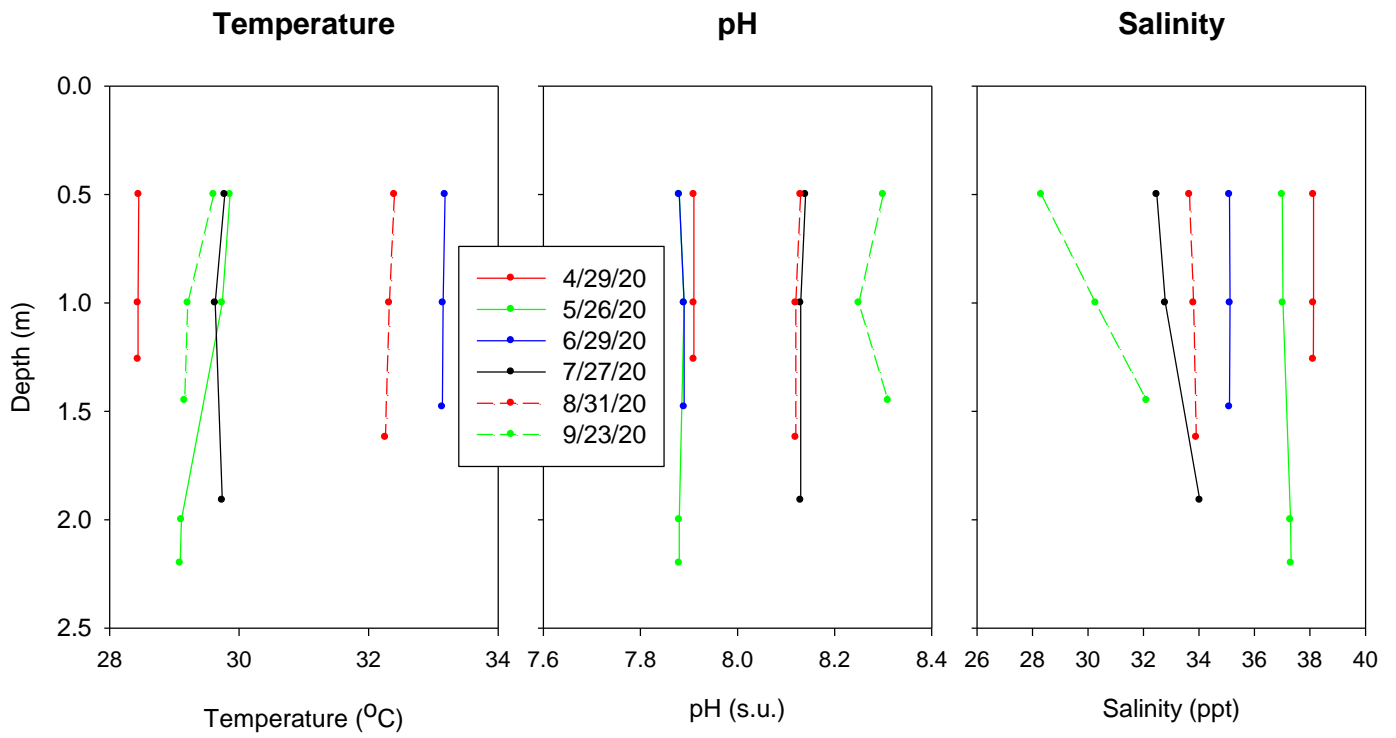

Vertical Field Profiles Collected in Marco Island at Site M-5.

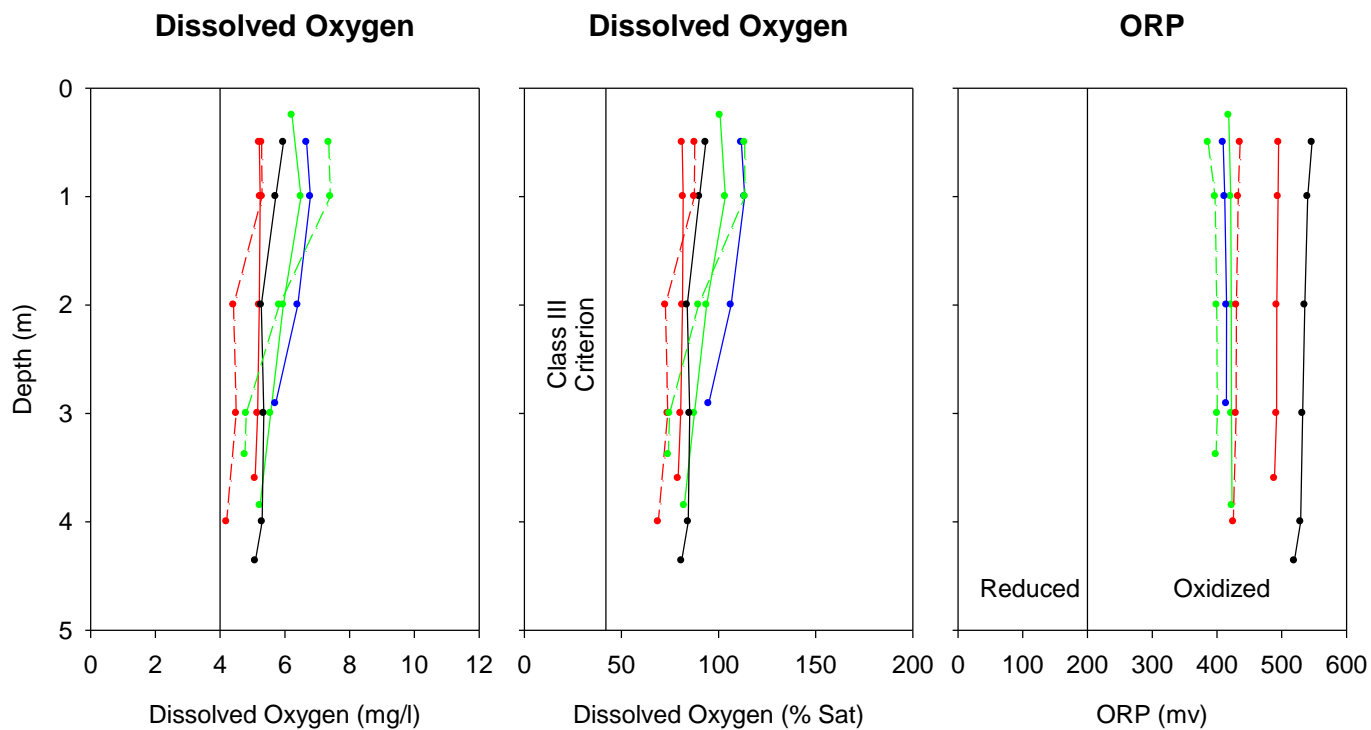
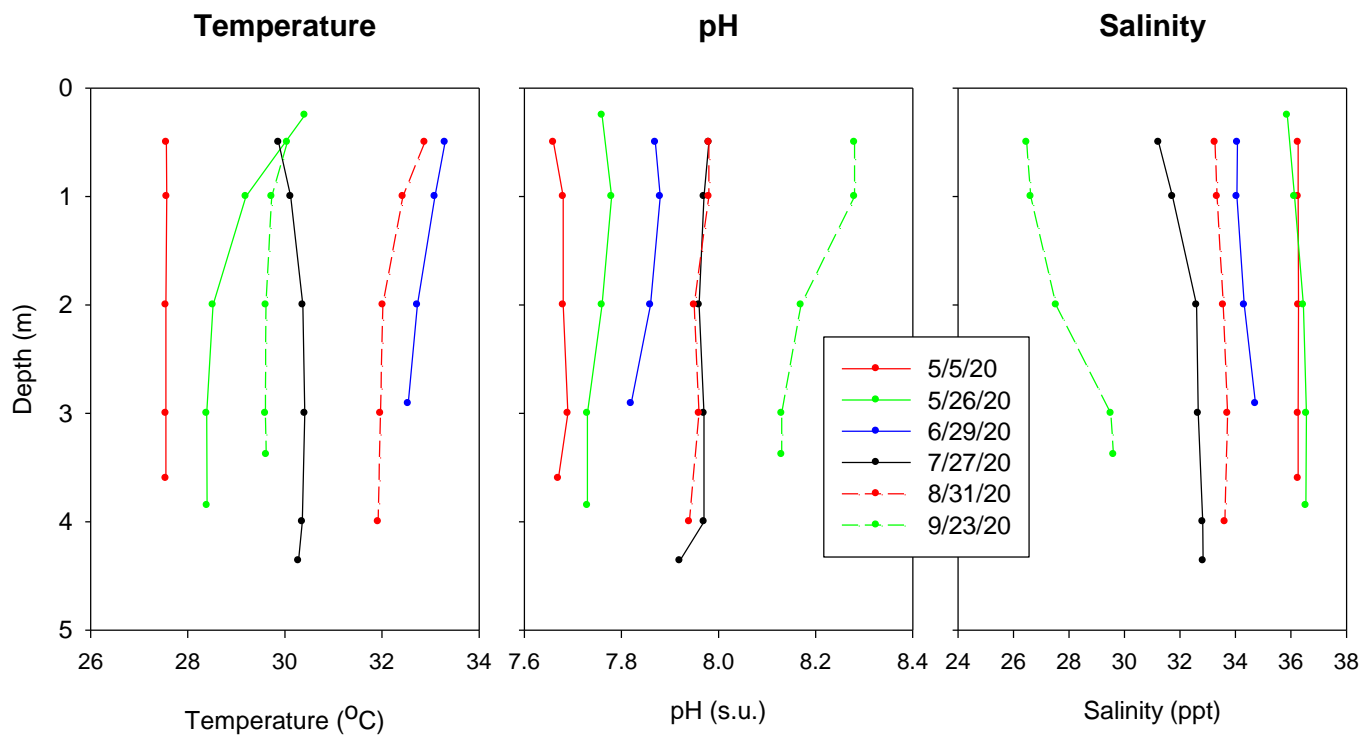

Vertical Field Profiles Collected in Marco Island at Site M-6.

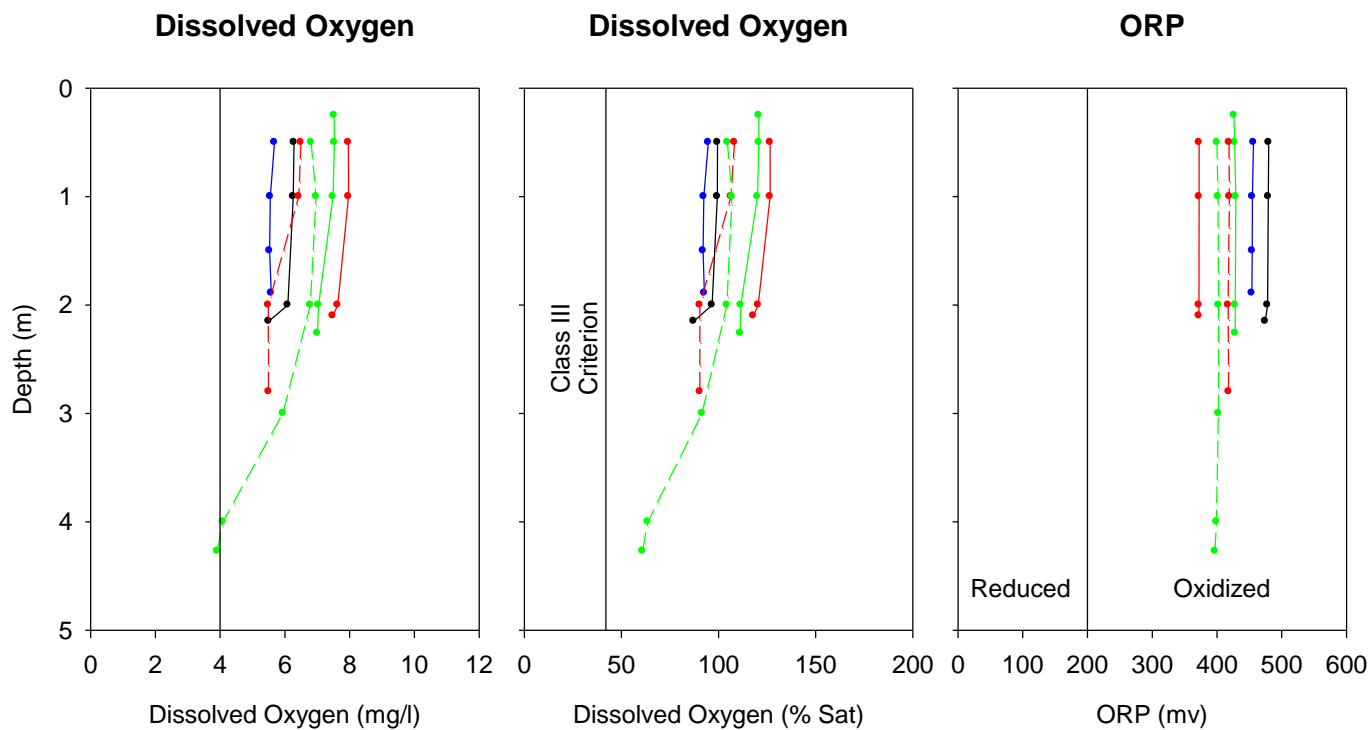
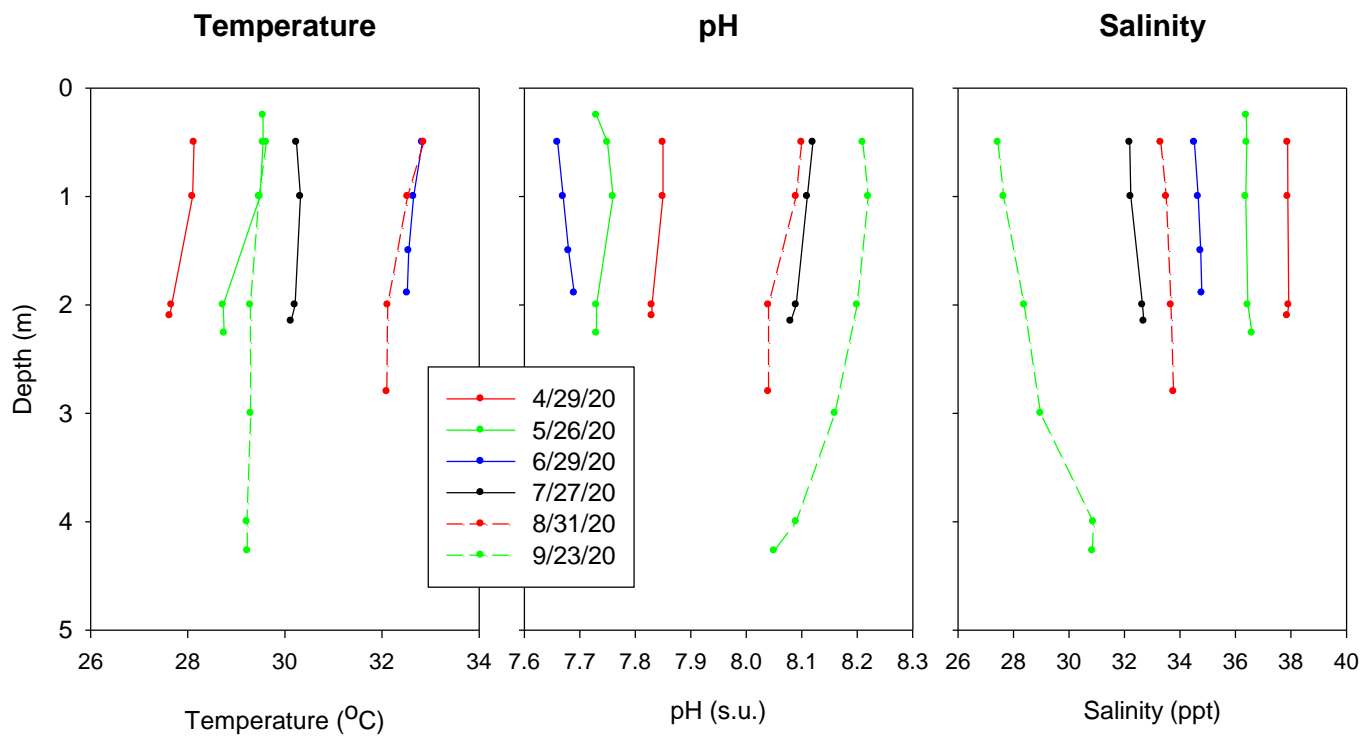

Vertical Field Profiles Collected in Marco Island at Site M-7.

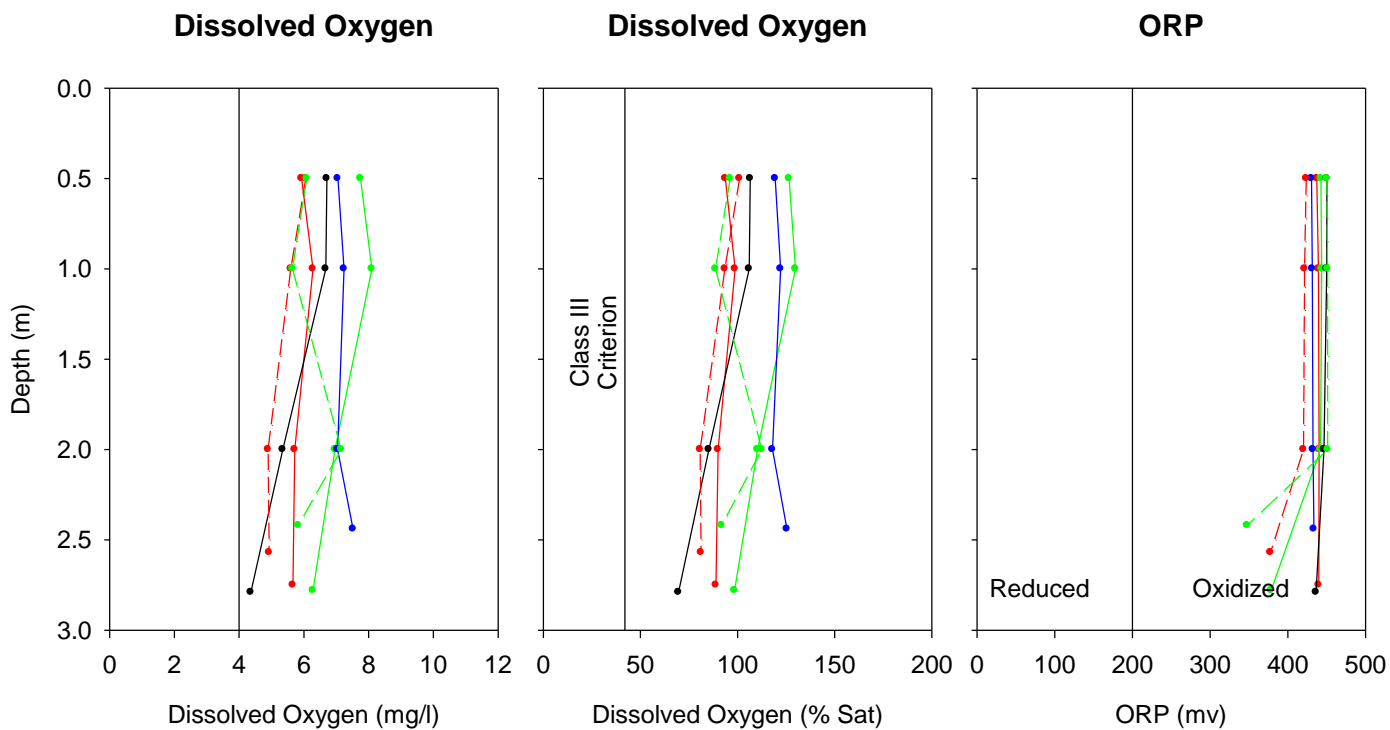
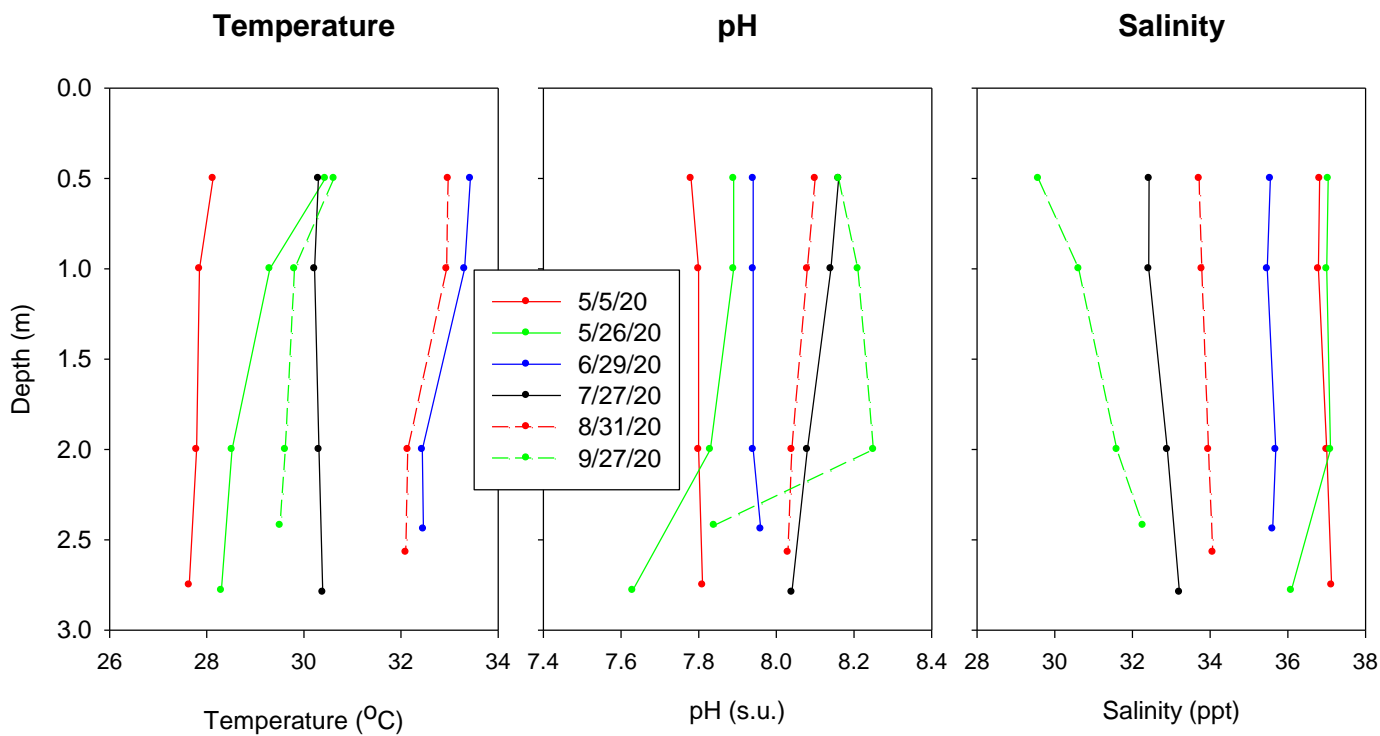

Vertical Field Profiles Collected in Marco Island at Site M-8.

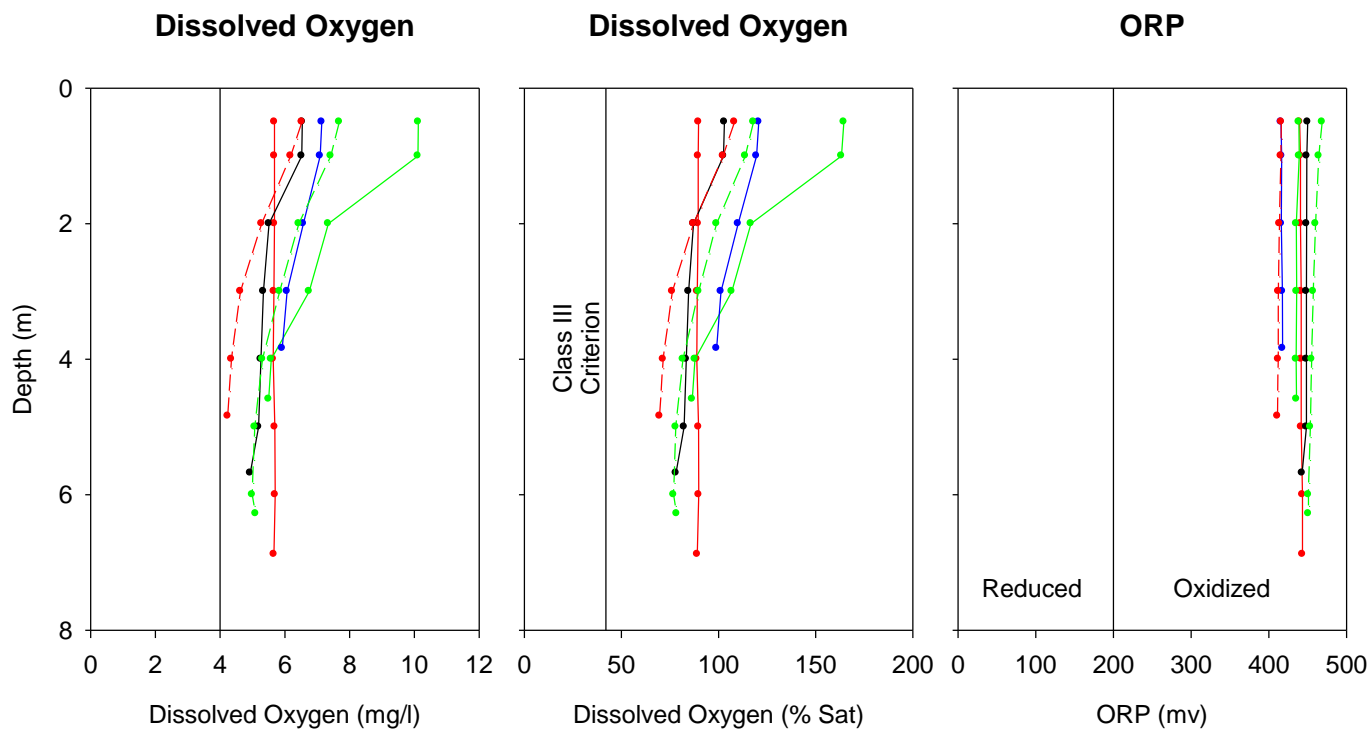
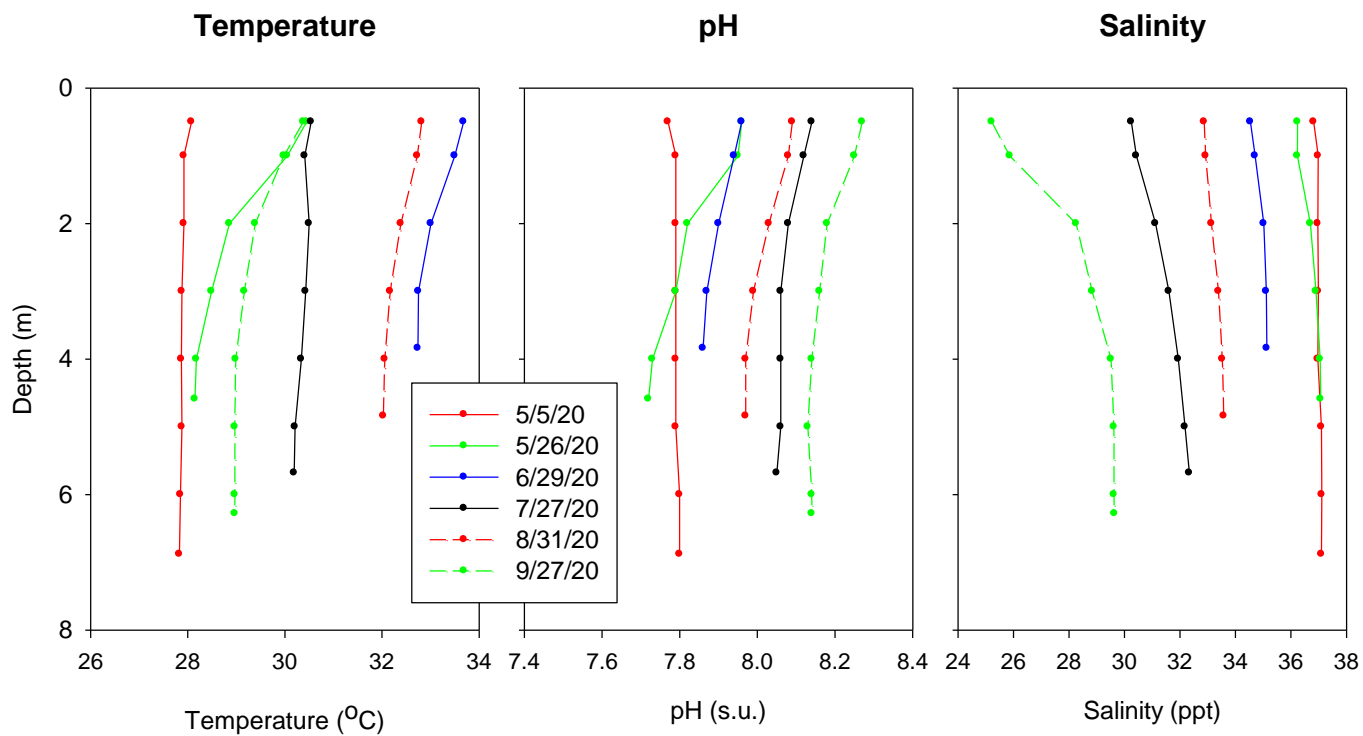

Vertical Field Profiles Collected in Marco Island at Site M-9.

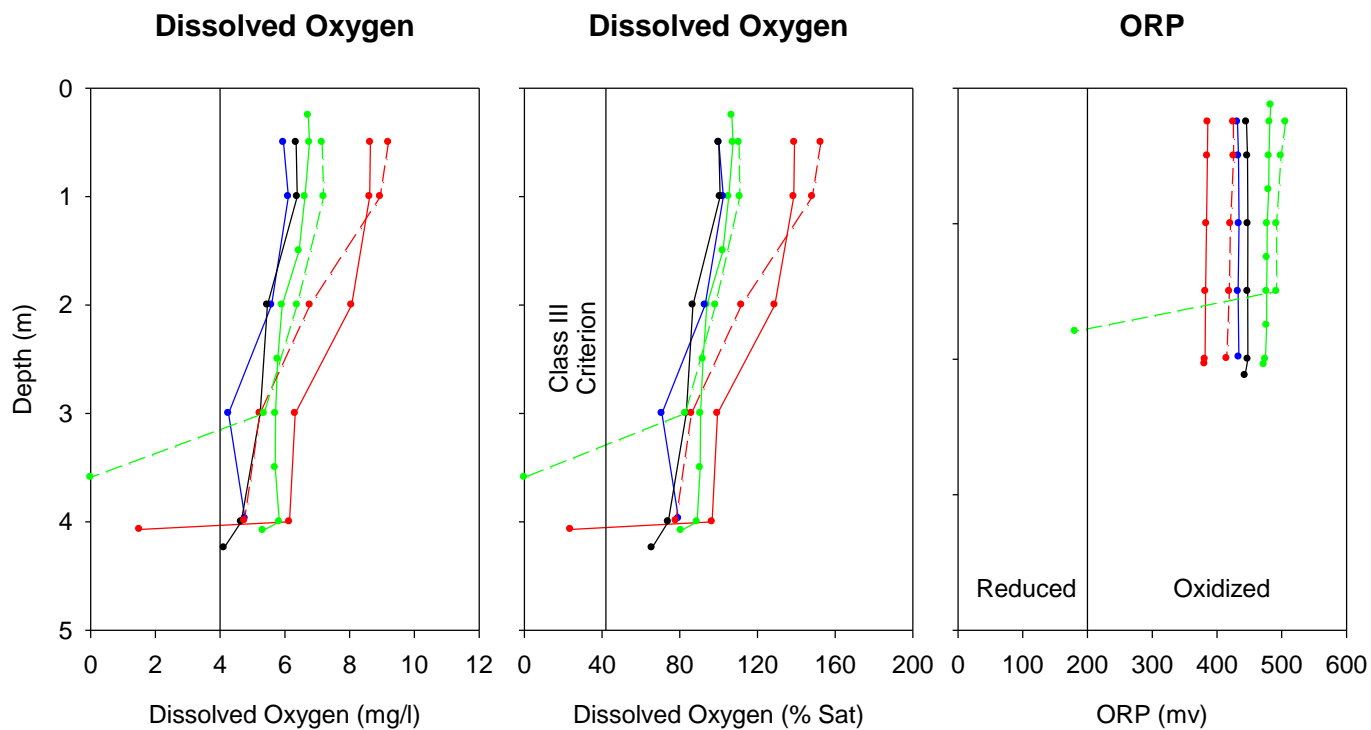
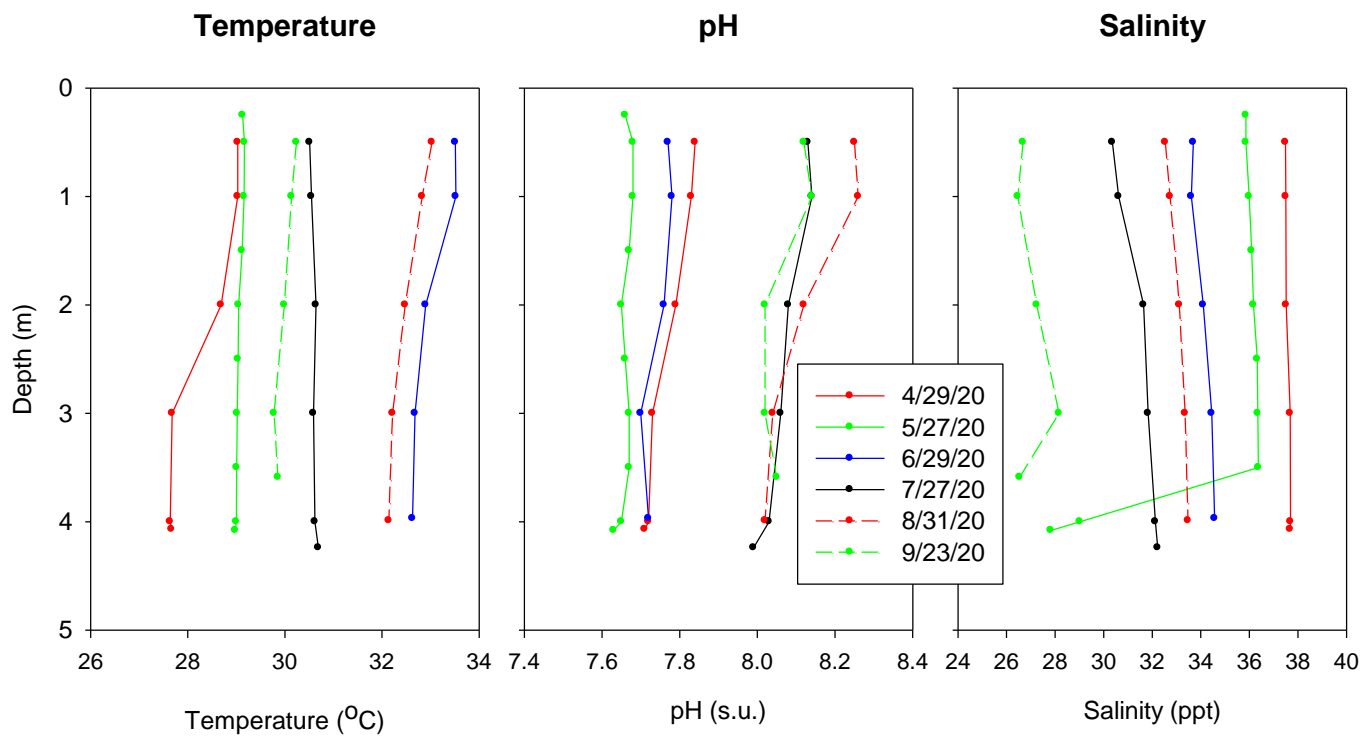

Vertical Field Profiles Collected in Marco Island at Site M-10.

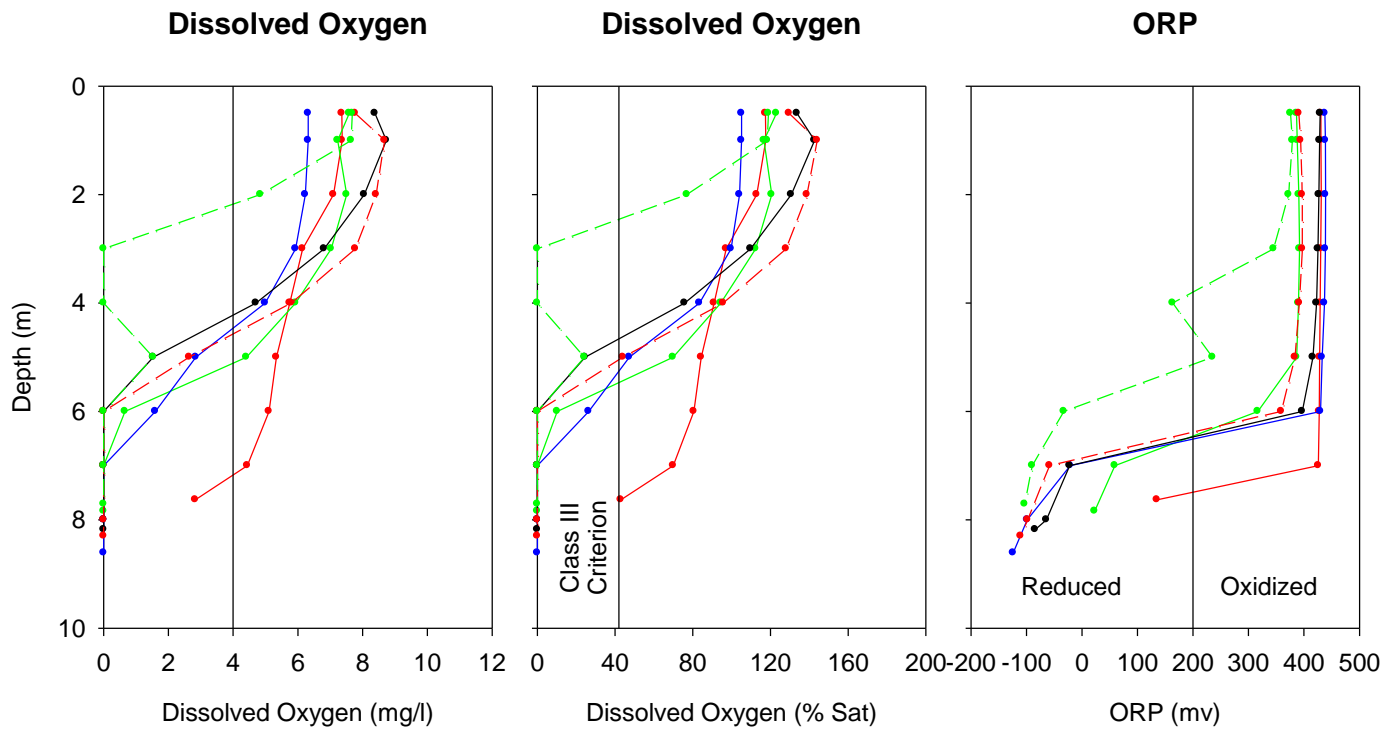
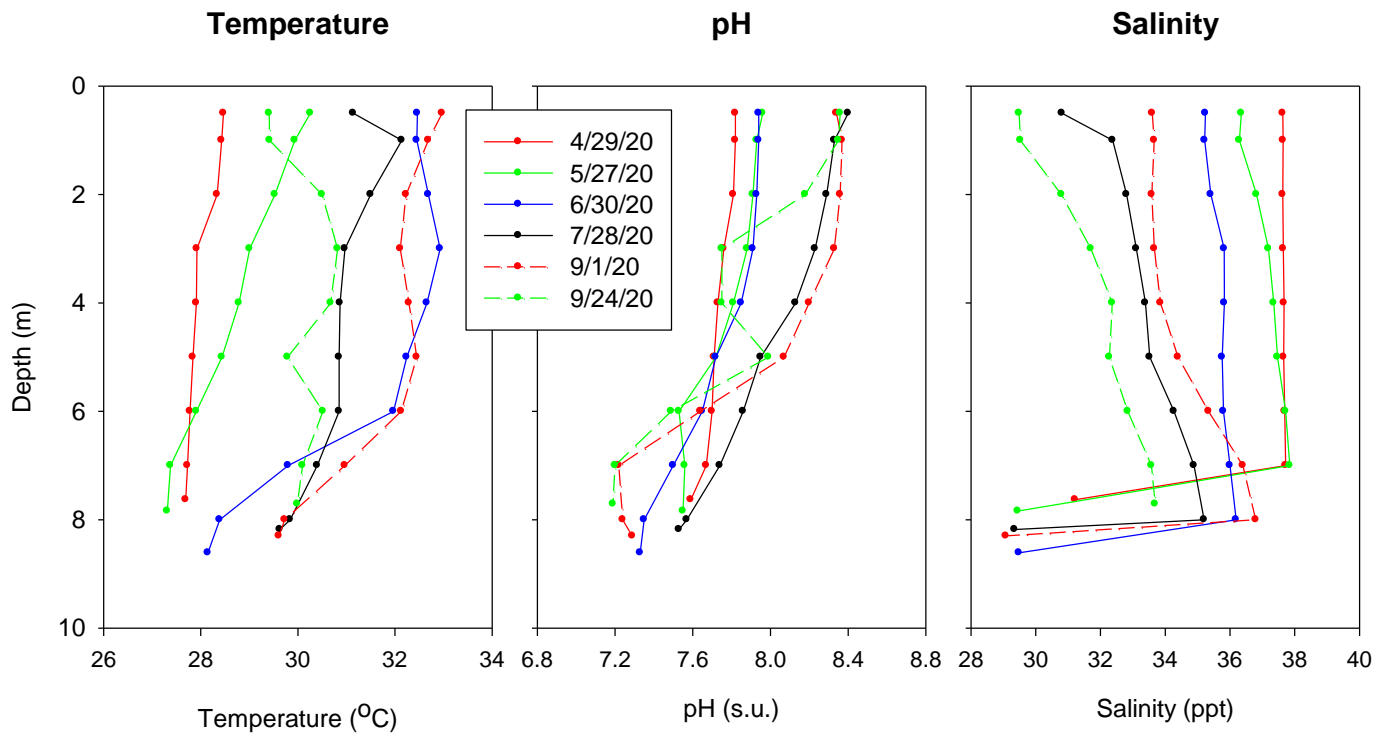

Vertical Field Profiles Collected in Marco Island at Site M-11.

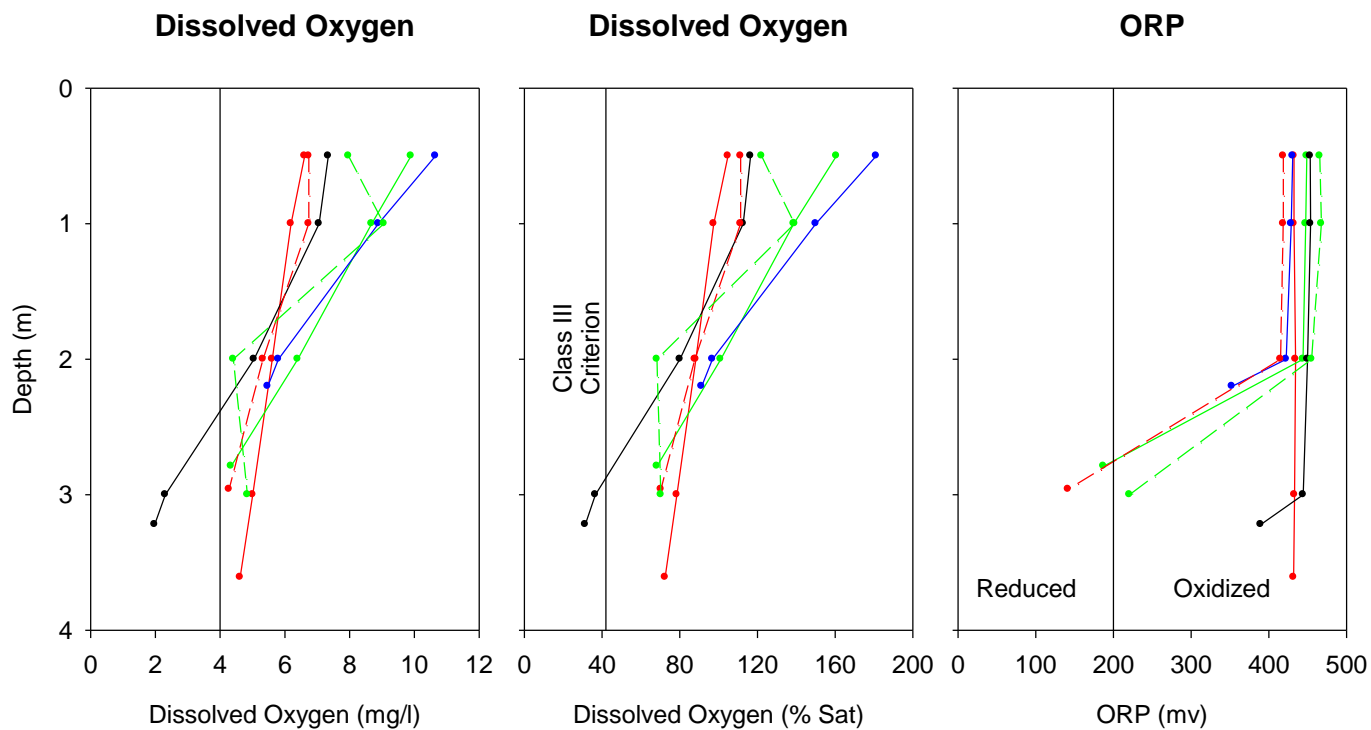
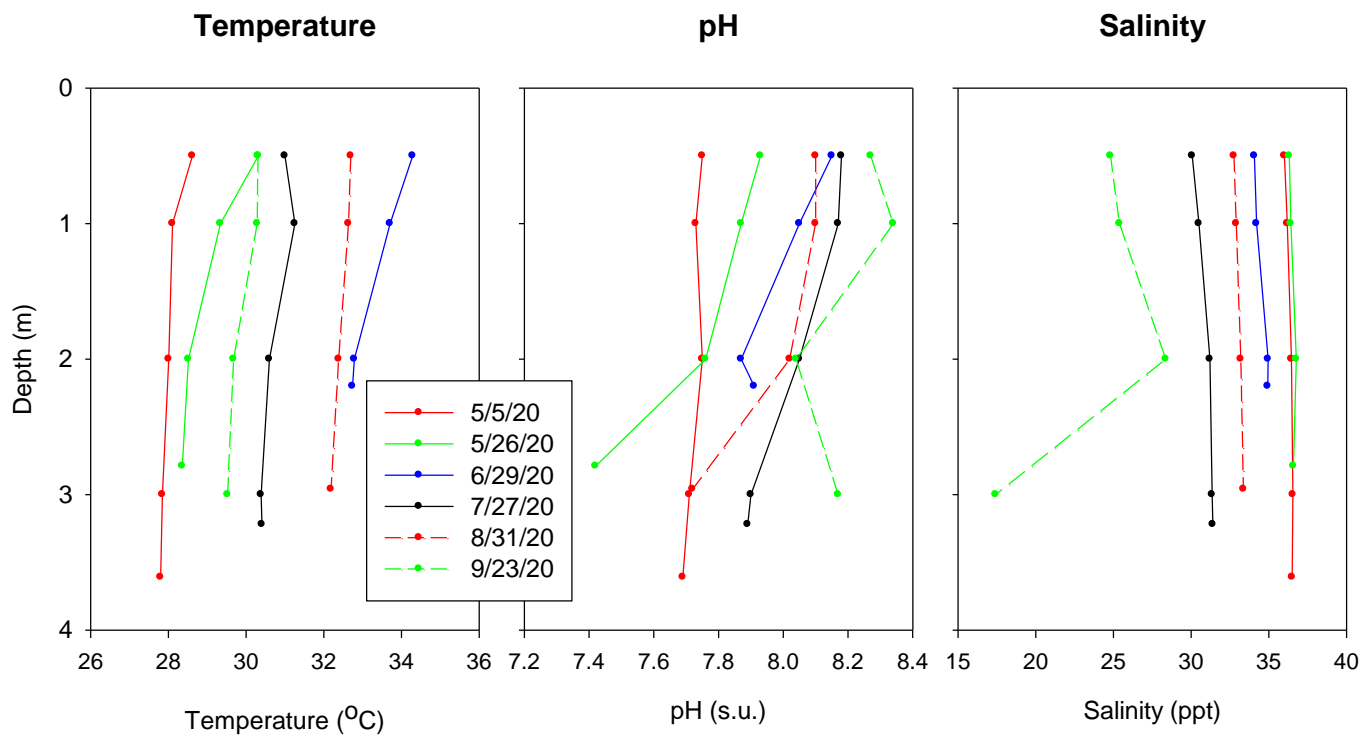

Vertical Field Profiles Collected in Marco Island at Site M-12.

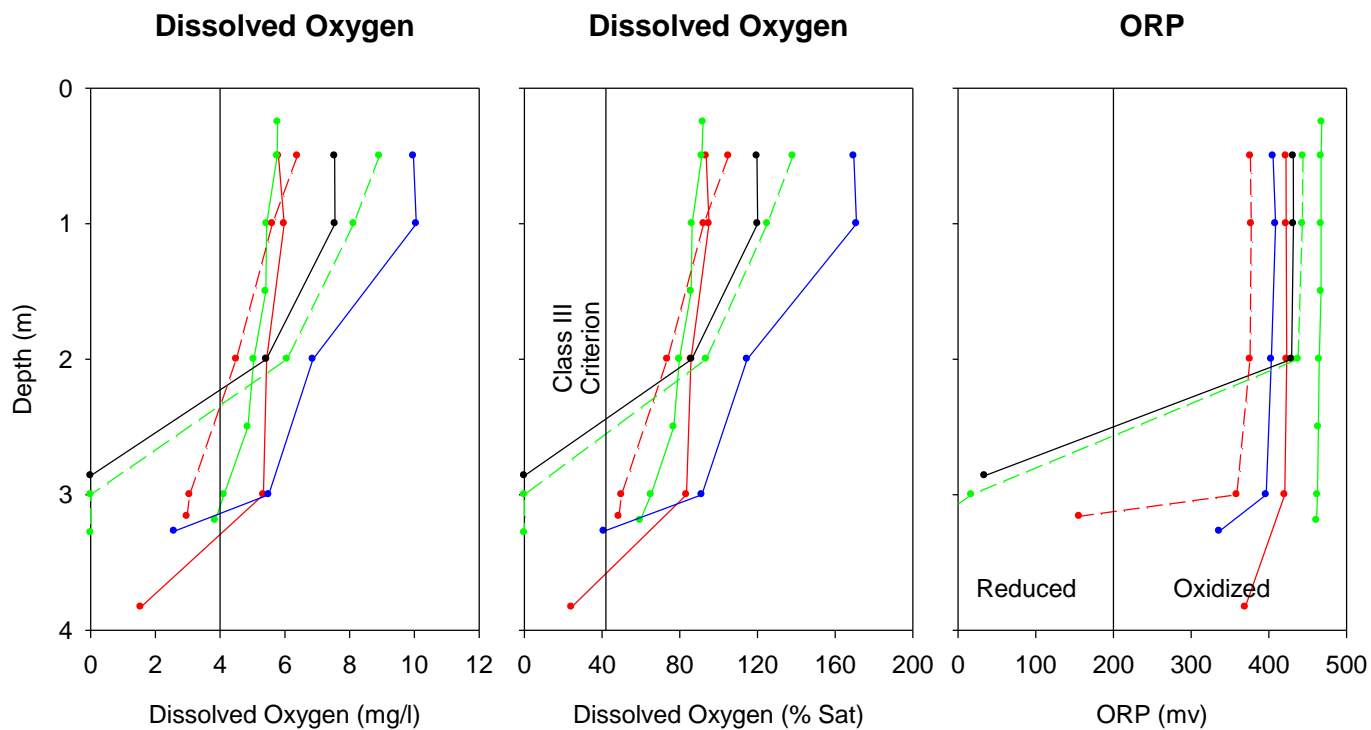
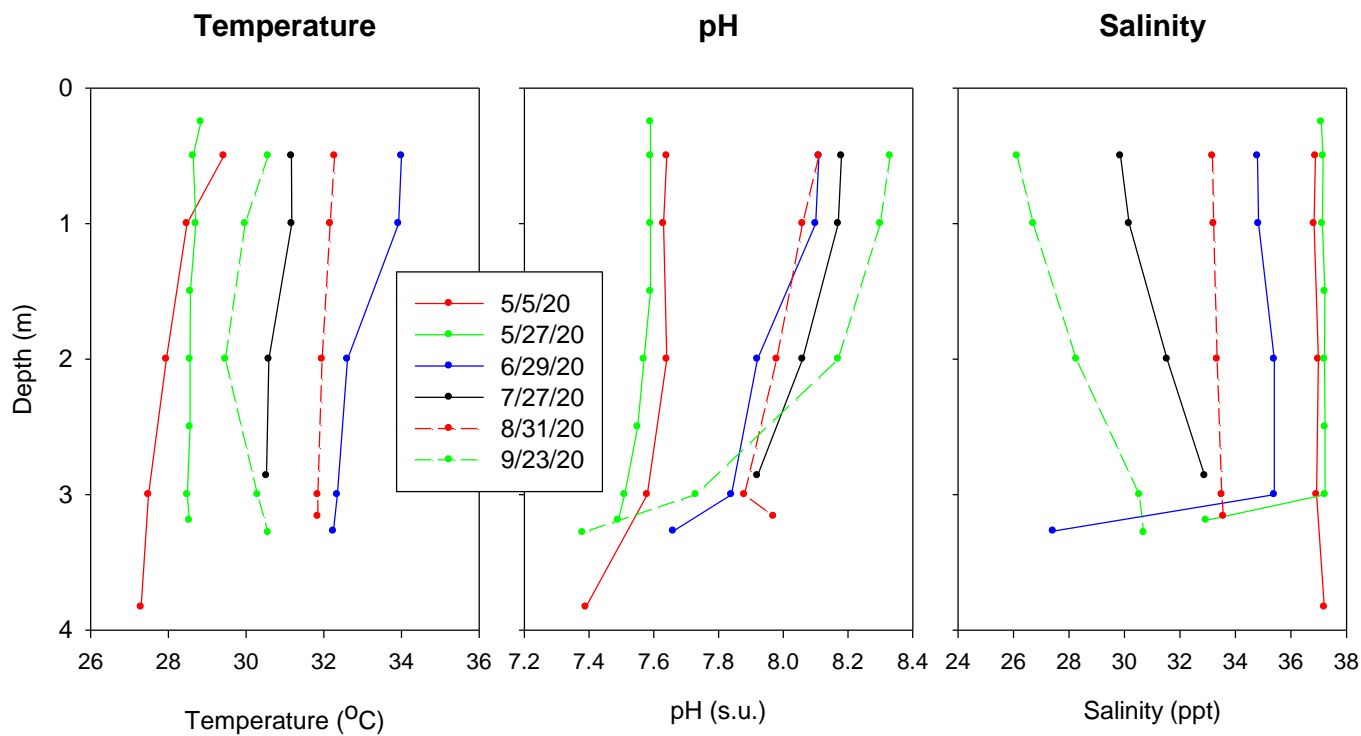

Vertical Field Profiles Collected in Marco Island at Site M-13.

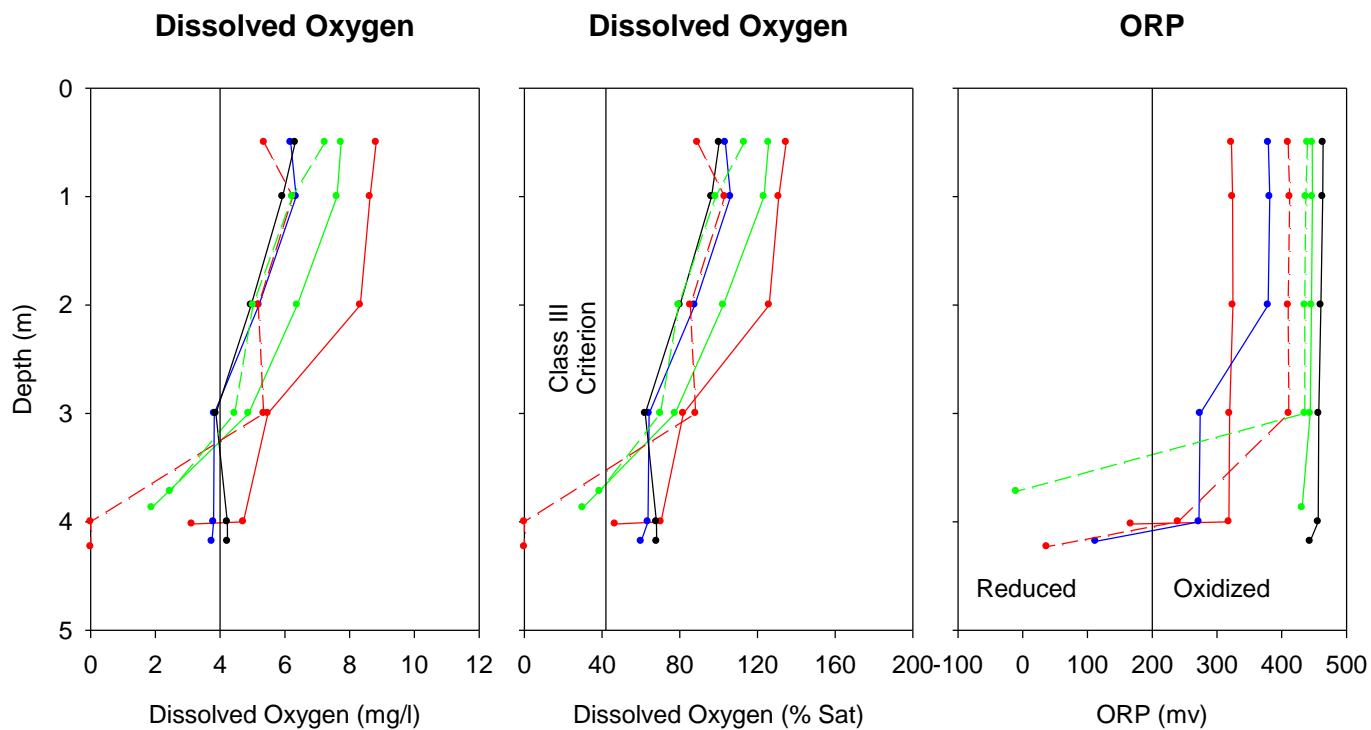
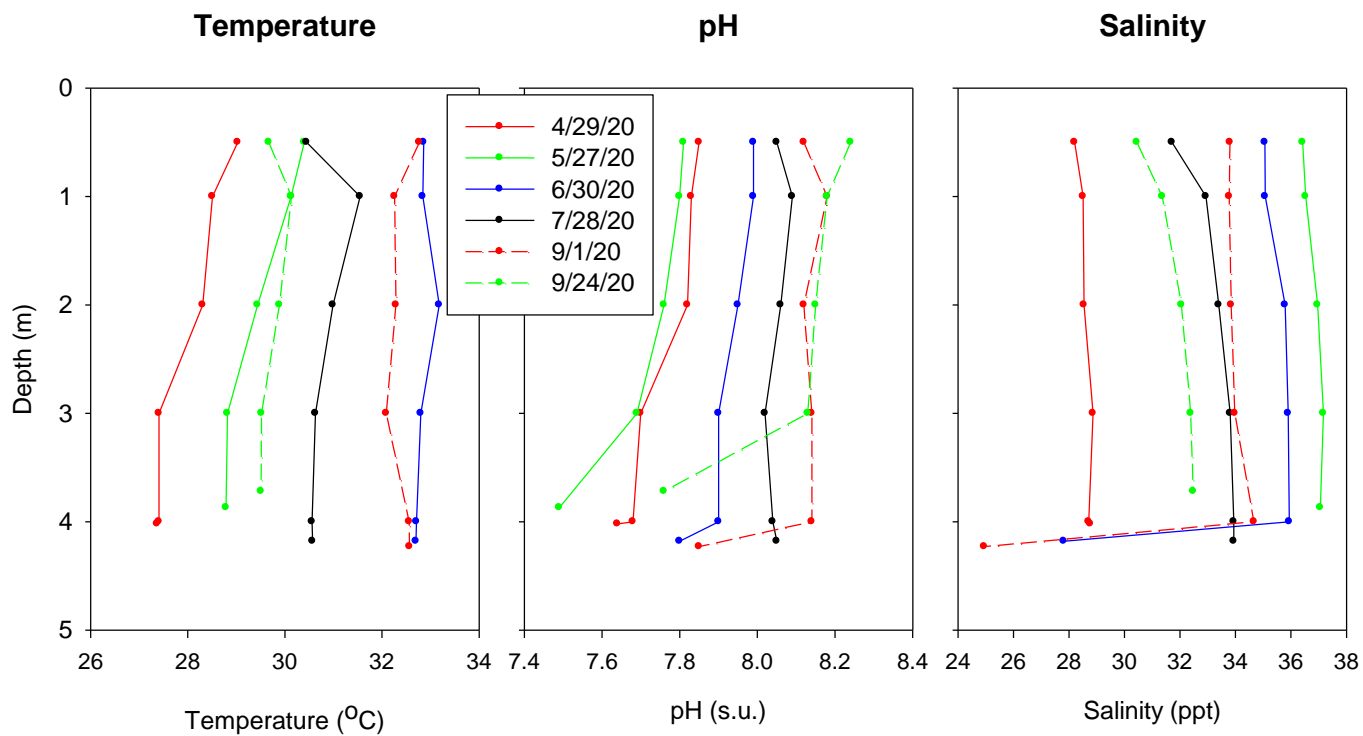

Vertical Field Profiles Collected in Marco Island at Site M-14.

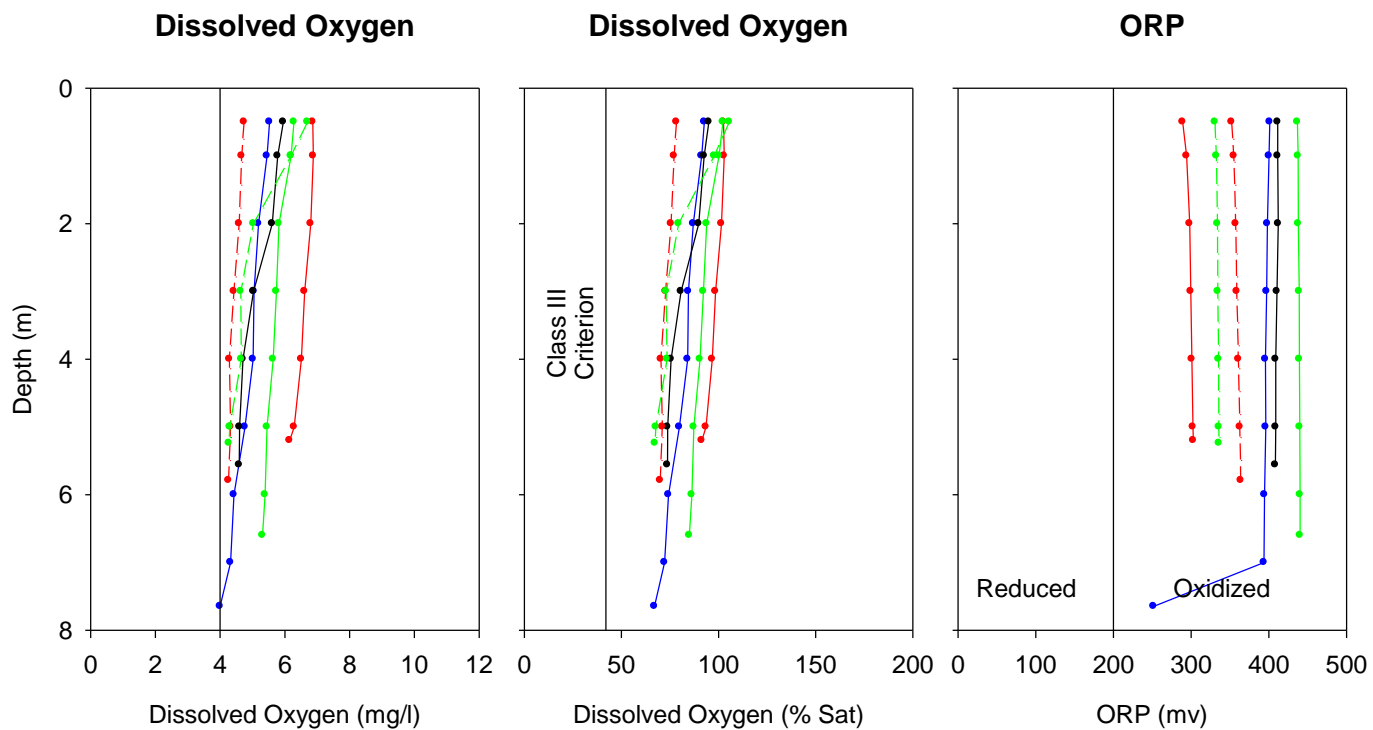
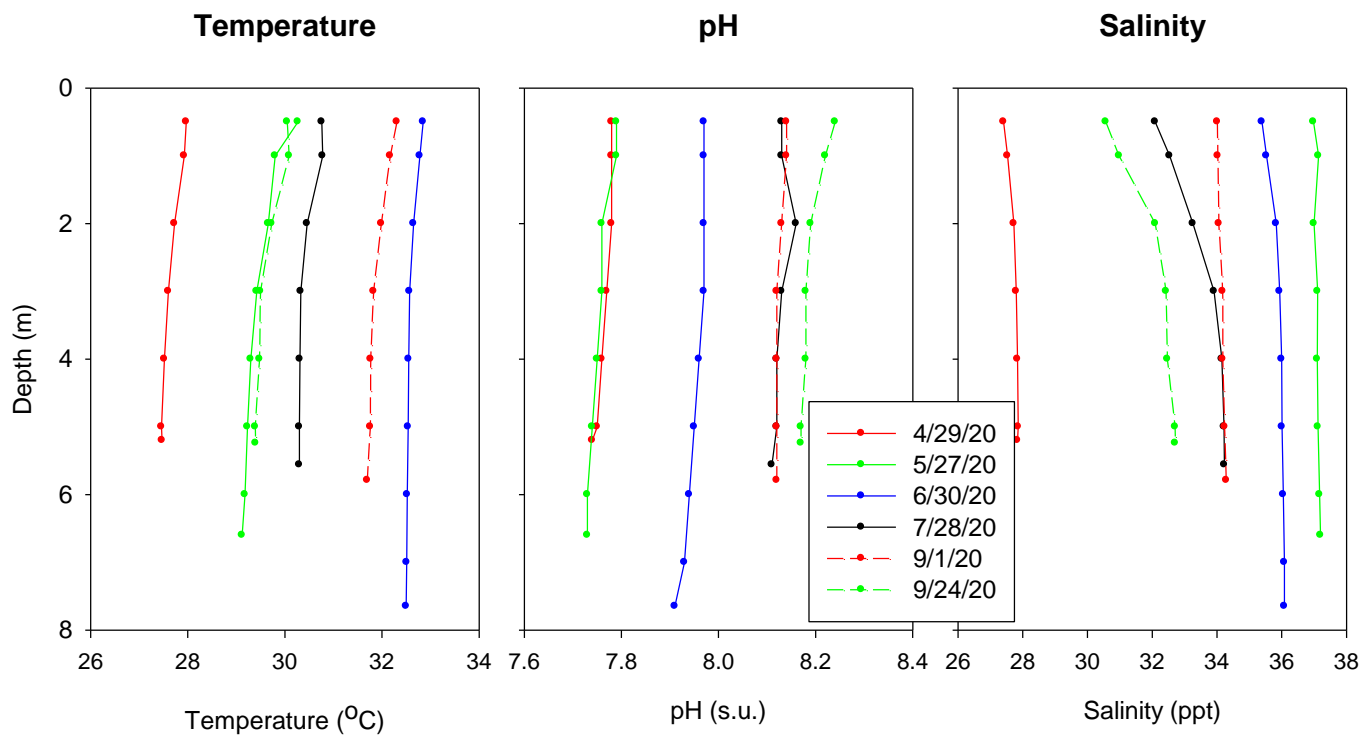

Vertical Field Profiles Collected in Marco Island at Site M-15.

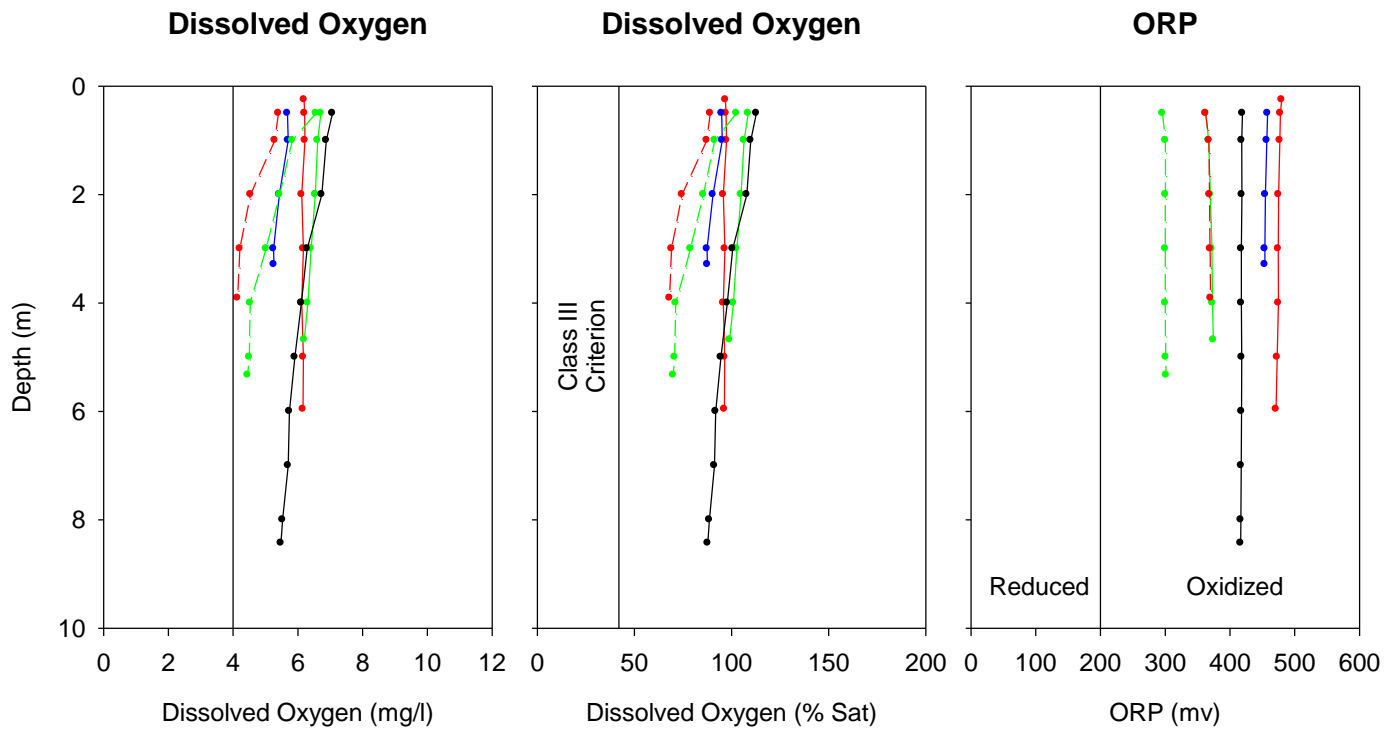
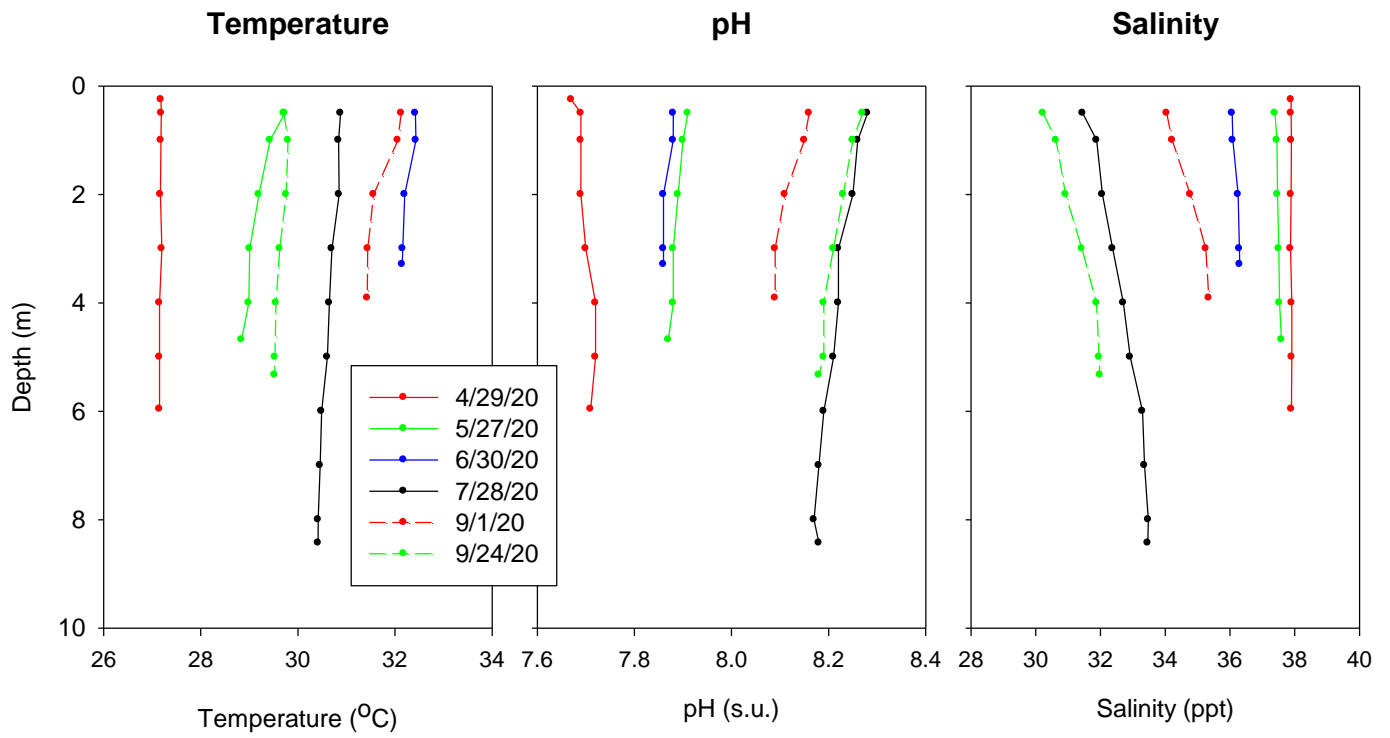

Vertical Field Profiles Collected in Marco Island at Site M-16.

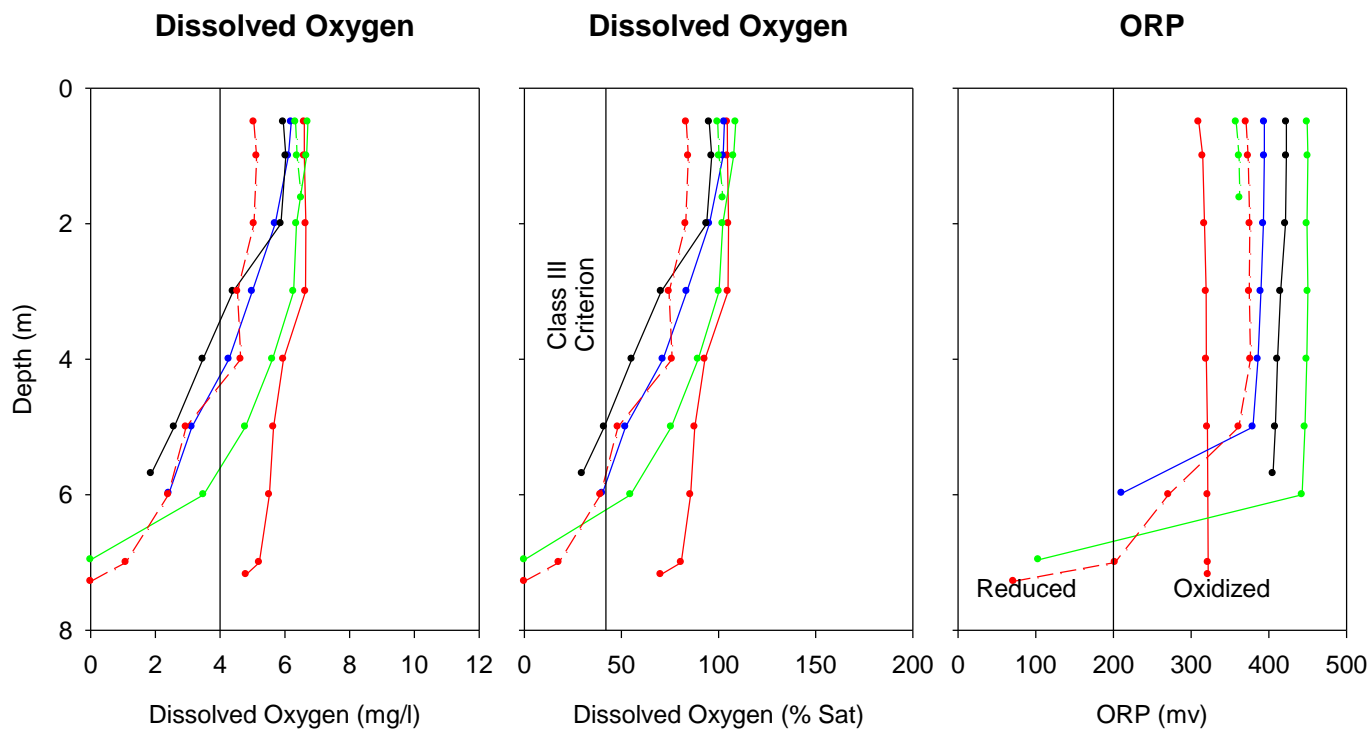
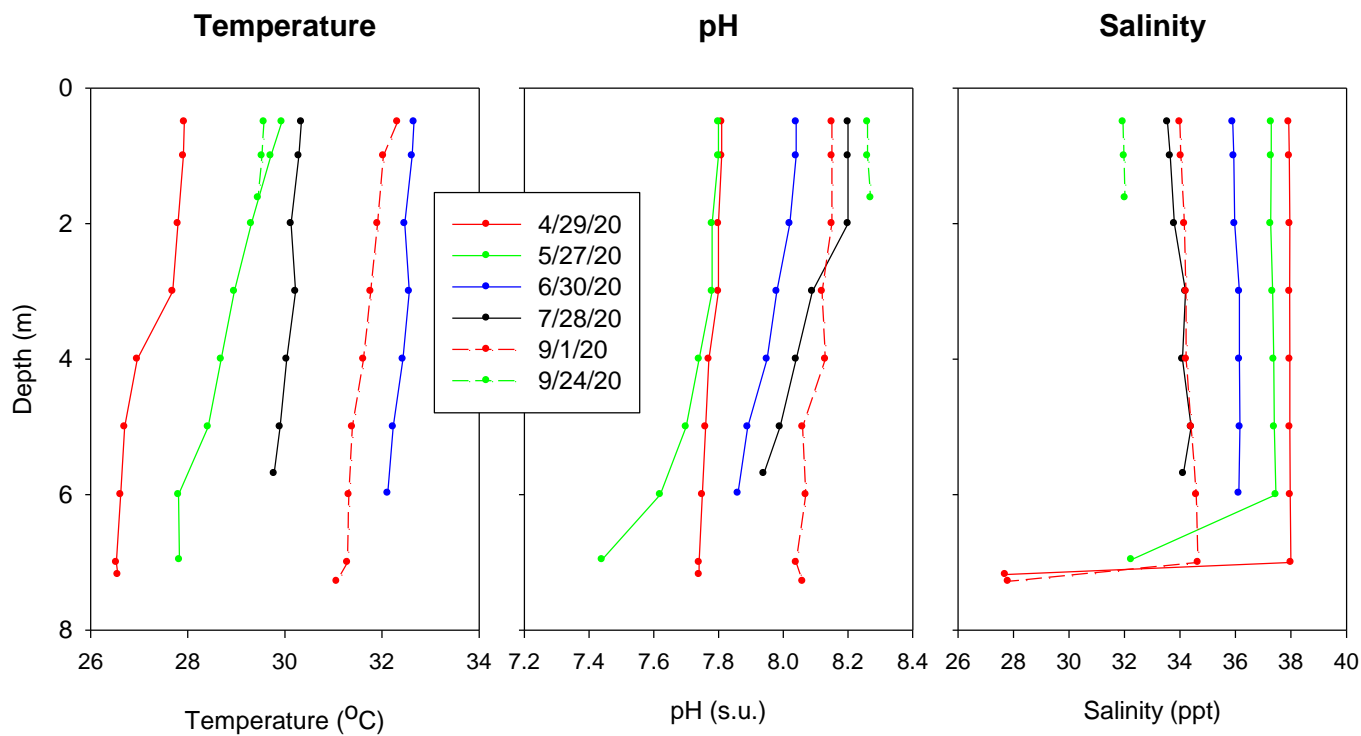

Vertical Field Profiles Collected in Marco Island at Site M-17.

B-2 Characteristics of Surface Water Samples

Water Quality Characteristics of Surface Water Samples Collected at Marco Island from April - September 2020

| Lab ID | Location | Date Collected | Alkalinity (mg/L) | Ammonia N (µg/L) | NOx-N (µg/L) | Diss.Org. N (µg/L) | Part. N (µg/L) | Total N (µg/L) | Diss. TN (µg/L) | SRP (µg/L) | Diss.Org. P (µg/L) | Part. P (µg/L) | Total P (µg/L) | Diss. TP (µg/L) | Turbidity (NTU) | Color (Pt-Co) | Chyl-a (µg/L) |
|-----------------|----------|----------------|-------------------|------------------|--------------|--------------------|----------------|----------------|-----------------|------------|--------------------|----------------|----------------|-----------------|-----------------|---------------|---------------|
| 1432 | | 5/5/20 | 130 | 3 | 7 | 479 | 127 | 616 | 489 | 34 | 11 | 12 | 57 | 45 | 2.6 | 1 | 2.5 |
| 1620 | | 5/26/20 | 135 | 3 | 14 | 662 | 123 | 802 | 679 | 56 | 75 | 18 | 149 | 131 | 4.9 | 4 | 10.1 |
| 2075 | M-1 | 6/29/20 | 138 | 3 | 2 | 489 | 125 | 619 | 494 | 71 | 9 | 16 | 96 | 80 | 3.1 | 9 | 18.1 |
| 2412 | | 7/27/20 | 125 | 16 | 2 | 285 | 276 | 579 | 303 | 31 | 17 | 18 | 66 | 48 | 6.2 | 6 | 11.7 |
| 2830 | | 8/31/20 | 131 | 3 | 2 | 315 | 118 | 438 | 320 | 44 | 28 | 5 | 77 | 72 | 4.8 | 9 | 16.6 |
| 3108 | | 9/23/20 | 137 | 3 | 2 | 372 | 134 | 511 | 377 | 31 | 38 | 8 | 77 | 69 | 2.5 | 14 | 14.4 |
| Minimum Value: | | | 125 | 3 | 2 | 285 | 118 | 438 | 303 | 31 | 9 | 5 | 57 | 45 | 3 | 1 | 2.5 |
| Maximum Value: | | | 138 | 16 | 14 | 662 | 276 | 802 | 679 | 71 | 75 | 18 | 149 | 131 | 6 | 14 | 18.1 |
| Geometric Mean: | | | 133 | 4 | 3 | 416 | 143 | 584 | 426 | 42 | 23 | 12 | 83 | 69 | 4 | 5 | 10.4 |
| 1427 | | 5/5/20 | 145 | 3 | 14 | 671 | 126 | 814 | 688 | 61 | 27 | 53 | 141 | 88 | 7.5 | 12 | 9.6 |
| 1628 | | 5/26/20 | 142 | 3 | 18 | 699 | 183 | 903 | 720 | 61 | 41 | 51 | 153 | 102 | 7.9 | 13 | 10.4 |
| 2076 | M-2 | 6/29/20 | 134 | 64 | 2 | 263 | 122 | 451 | 329 | 87 | 57 | 17 | 161 | 144 | 2.6 | 7 | 16.6 |
| 2413 | | 7/27/20 | 139 | 3 | 7 | 337 | 319 | 666 | 347 | 73 | 50 | 22 | 145 | 123 | 9.6 | 16 | 16.4 |
| 2831 | | 8/31/20 | 136 | 3 | 2 | 362 | 175 | 542 | 367 | 48 | 27 | 103 | 178 | 75 | 26.8 | 15 | 32.3 |
| 3109 | | 9/23/20 | 132 | 3 | 2 | 306 | 155 | 466 | 311 | 42 | 36 | 54 | 132 | 78 | 2.7 | 10 | 12.4 |
| Minimum Value: | | | 132 | 3 | 2 | 263 | 122 | 451 | 311 | 42 | 27 | 17 | 132 | 75 | 3 | 7 | 9.6 |
| Maximum Value: | | | 145 | 64 | 18 | 699 | 319 | 903 | 720 | 87 | 57 | 103 | 178 | 144 | 27 | 16 | 32.3 |
| Geometric Mean: | | | 138 | 5 | 5 | 408 | 170 | 618 | 431 | 60 | 38 | 42 | 151 | 99 | 7 | 12 | 14.9 |
| 1402 | | 4/29/20 | 138 | 3 | 11 | 465 | 65 | 544 | 479 | 35 | 17 | 23 | 75 | 52 | 2.2 | 1 | 6.1 |
| 1636 | | 5/27/20 | 129 | 20 | 10 | 695 | 88 | 813 | 725 | 55 | 16 | 28 | 99 | 71 | 2.8 | 23 | 5.2 |
| 2088 | M-3 | 6/30/20 | 140 | 3 | 2 | 407 | 96 | 508 | 412 | 64 | 43 | 77 | 184 | 107 | 1.9 | 1 | 9.8 |
| 2425 | | 7/28/20 | 124 | 3 | 12 | 359 | 105 | 479 | 374 | 80 | 25 | 13 | 118 | 105 | 9.1 | 4 | 12.9 |
| 2843 | | 8/31/20 | 130 | 3 | 2 | 460 | 95 | 560 | 465 | 53 | 27 | 100 | 180 | 80 | 0.5 | 4 | 16.1 |
| 3122 | | 9/24/20 | 138 | 22 | 9 | 580 | 17 | 628 | 611 | 67 | 40 | 66 | 173 | 107 | 2.8 | 6 | 8.5 |
| Minimum Value: | | | 124 | 3 | 2 | 359 | 17 | 479 | 374 | 35 | 16 | 13 | 75 | 52 | 1 | 1 | 5.2 |
| Maximum Value: | | | 140 | 22 | 12 | 695 | 105 | 813 | 725 | 80 | 43 | 100 | 184 | 107 | 9 | 23 | 16.1 |
| Geometric Mean: | | | 133 | 6 | 6 | 482 | 67 | 579 | 498 | 57 | 26 | 40 | 131 | 84 | 2 | 4 | 9.0 |
| 1401 | | 4/29/20 | 139 | 3 | 5 | 525 | 41 | 574 | 533 | 34 | 12 | 29 | 75 | 46 | 3.9 | 1 | 6.4 |
| 1635 | | 5/27/20 | 130 | 3 | 15 | 605 | 119 | 742 | 623 | 55 | 29 | 25 | 109 | 84 | 3.0 | 23 | 5.5 |
| 2089 | M-4 | 6/30/20 | 117 | 3 | 3 | 425 | 44 | 475 | 431 | 65 | 28 | 60 | 153 | 93 | 3.0 | 1 | 8.6 |
| 2426 | | 7/28/20 | 127 | 17 | 10 | 344 | 34 | 405 | 371 | 91 | 17 | 27 | 135 | 108 | 5.8 | 4 | 7.1 |
| 2844 | | 8/31/20 | 134 | 3 | 2 | 433 | 12 | 450 | 438 | 63 | 13 | 14 | 90 | 76 | 0.5 | 3 | 8.4 |
| 3110 | | 9/24/20 | 141 | 20 | 2 | 482 | 13 | 517 | 504 | 59 | 25 | 89 | 173 | 84 | 5.3 | 9 | 12.8 |
| Minimum Value: | | | 117 | 3 | 2 | 344 | 12 | 405 | 371 | 34 | 12 | 14 | 75 | 46 | 1 | 1 | 5.5 |
| Maximum Value: | | | 141 | 20 | 15 | 605 | 119 | 742 | 623 | 91 | 29 | 89 | 173 | 108 | 6 | 23 | 12.8 |
| Geometric Mean: | | | 131 | 5 | 5 | 462 | 32 | 517 | 477 | 59 | 19 | 34 | 117 | 79 | 3 | 4 | 7.8 |

Water Quality Characteristics of Surface Water Samples Collected at Marco Island from April - September 2020

| Lab ID | Location | Date Collected | Alkalinity (mg/L) | Ammonia N (µg/L) | NOx-N (µg/L) | Diss.Org. N (µg/L) | Part. N (µg/L) | Total N (µg/L) | Diss. TN (µg/L) | SRP (µg/L) | Diss.Org. P (µg/L) | Part. P (µg/L) | Total P (µg/L) | Diss. TP (µg/L) | Turbidity (NTU) | Color (Pt-Co) | Chyl-a (µg/L) |
|--------|----------|-----------------|-------------------|------------------|--------------|--------------------|----------------|----------------|-----------------|------------|--------------------|----------------|----------------|-----------------|-----------------|---------------|---------------|
| 1403 | | 4/29/20 | 145 | 3 | 11 | 506 | 179 | 699 | 520 | 34 | 32 | 29 | 95 | 66 | 11.4 | 3 | 6.8 |
| 1619 | | 5/26/20 | 140 | 3 | 14 | 563 | 132 | 712 | 580 | 55 | 26 | 96 | 177 | 81 | 3.9 | 3 | 8.2 |
| 2077 | M-5 | 6/29/20 | 133 | 3 | 2 | 479 | 21 | 505 | 484 | 61 | 18 | 19 | 98 | 79 | 6.5 | 5 | 14.0 |
| 2414 | | 7/27/20 | 130 | 3 | 15 | 308 | 326 | 648 | 326 | 36 | 11 | 15 | 62 | 47 | 5.2 | 7 | 12.8 |
| 2832 | | 8/31/20 | 148 | 3 | 2 | 433 | 19 | 457 | 438 | 41 | 21 | 19 | 81 | 62 | 3.5 | 9 | 15.0 |
| 3111 | | 9/23/20 | 138 | 3 | 2 | 461 | 29 | 495 | 466 | 48 | 14 | 39 | 101 | 62 | 3.4 | 11 | 14.1 |
| | | Minimum Value: | 130 | 3 | 2 | 308 | 19 | 457 | 326 | 34 | 11 | 15 | 62 | 47 | 3 | 3 | 6.8 |
| | | Maximum Value: | 148 | 3 | 15 | 563 | 322 | 712 | 580 | 61 | 32 | 96 | 177 | 81 | 11 | 11 | 15.0 |
| | | Geometric Mean: | 139 | 3 | 5 | 451 | 67 | 577 | 462 | 45 | 19 | 29 | 97 | 65 | 5 | 6 | 11.3 |
| 1431 | | 5/5/20 | 142 | 15 | 18 | 433 | 69 | 535 | 486 | 41 | 27 | 16 | 84 | 68 | 2.6 | 7 | 5.4 |
| 1618 | | 5/26/20 | 138 | 13 | 25 | 638 | 78 | 754 | 676 | 63 | 28 | 37 | 128 | 91 | 2.0 | 8 | 14.9 |
| 2079 | M-6 | 6/29/20 | 139 | 3 | 2 | 419 | 60 | 484 | 424 | 63 | 49 | 23 | 135 | 112 | 3.1 | 6 | 20.8 |
| 2415 | | 7/27/20 | 127 | 15 | 14 | 400 | 198 | 627 | 429 | 72 | 26 | 15 | 113 | 98 | 2.4 | 9 | 10.6 |
| 2833 | | 8/31/20 | 139 | 3 | 2 | 424 | 96 | 525 | 429 | 40 | 27 | 17 | 84 | 67 | 2.4 | 10 | 18.5 |
| 3112 | | 9/23/20 | 134 | 16 | 2 | 428 | 105 | 551 | 446 | 57 | 26 | 47 | 130 | 83 | 1.3 | 14 | 32.3 |
| | | Minimum Value: | 127 | 3 | 2 | 400 | 60 | 484 | 424 | 40 | 26 | 15 | 84 | 67 | 1 | 6 | 5.4 |
| | | Maximum Value: | 142 | 16 | 25 | 638 | 198 | 754 | 676 | 72 | 49 | 47 | 135 | 112 | 3 | 14 | 32.3 |
| | | Geometric Mean: | 136 | 9 | 6 | 451 | 93 | 573 | 471 | 55 | 30 | 23 | 110 | 85 | 2 | 9 | 14.8 |
| 1404 | | 4/29/20 | 141 | 3 | 8 | 574 | 53 | 638 | 585 | 36 | 20 | 30 | 86 | 56 | 4.8 | 5 | 11.7 |
| 1617 | | 5/26/20 | 131 | 13 | 14 | 678 | 45 | 750 | 705 | 55 | 36 | 99 | 190 | 91 | 2.9 | 6 | 13.8 |
| 2080 | M-7 | 6/29/20 | 148 | 3 | 2 | 435 | 34 | 474 | 440 | 65 | 44 | 167 | 276 | 109 | 4.4 | 6 | 17.0 |
| 2416 | | 7/27/20 | 134 | 3 | 7 | 412 | 177 | 599 | 422 | 49 | 15 | 20 | 84 | 64 | 3.0 | 7 | 14.3 |
| 2834 | | 8/31/20 | 129 | 3 | 2 | 392 | 31 | 428 | 397 | 39 | 24 | 12 | 75 | 63 | 2.1 | 9 | 15.4 |
| 3114 | | 9/23/20 | 142 | 21 | 2 | 413 | 65 | 501 | 436 | 36 | 33 | 20 | 89 | 69 | 1.1 | 14 | 19.7 |
| | | Minimum Value: | 129 | 3 | 2 | 392 | 31 | 428 | 397 | 36 | 15 | 12 | 75 | 56 | 1 | 5 | 11.7 |
| | | Maximum Value: | 148 | 21 | 14 | 678 | 177 | 750 | 705 | 65 | 44 | 167 | 276 | 109 | 5 | 14 | 19.7 |
| | | Geometric Mean: | 137 | 5 | 4 | 474 | 55 | 555 | 486 | 45 | 27 | 37 | 117 | 73 | 3 | 7 | 15.1 |
| 1433 | | 5/5/20 | 139 | 3 | 23 | 564 | 78 | 668 | 590 | 37 | 19 | 18 | 74 | 56 | 7.1 | 7 | 16.7 |
| 1621 | | 5/26/20 | 131 | 3 | 12 | 647 | 108 | 770 | 662 | 55 | 17 | 61 | 133 | 72 | 2.3 | 6 | 7.1 |
| 2082 | M-8 | 6/29/20 | 136 | 3 | 2 | 442 | 84 | 531 | 447 | 64 | 14 | 25 | 103 | 78 | 3.2 | 8 | 11.9 |
| 2418 | | 7/27/20 | 119 | 15 | 2 | 391 | 195 | 603 | 408 | 39 | 22 | 28 | 89 | 61 | 2.4 | 11 | 24.5 |
| 2836 | | 8/31/20 | 118 | 3 | 2 | 394 | 126 | 525 | 399 | 24 | 24 | 29 | 77 | 48 | 1.1 | 12 | 8.7 |
| 3116 | | 9/23/20 | 129 | 3 | 2 | 455 | 163 | 623 | 460 | 32 | 24 | 27 | 83 | 56 | 1.1 | 15 | 26.9 |
| | | Minimum Value: | 118 | 3 | 2 | 391 | 78 | 525 | 399 | 24 | 14 | 18 | 74 | 48 | 1 | 6 | 7.1 |
| | | Maximum Value: | 139 | 15 | 23 | 647 | 195 | 770 | 662 | 64 | 24 | 61 | 133 | 78 | 7 | 15 | 26.9 |
| | | Geometric Mean: | 128 | 4 | 4 | 474 | 119 | 615 | 485 | 40 | 20 | 29 | 91 | 61 | 2 | 9 | 14.2 |

Water Quality Characteristics of Surface Water Samples Collected at Marco Island from April - September 2020

| Lab ID | Location | Date Collected | Alkalinity (mg/L) | Ammonia N (µg/L) | NOx-N (µg/L) | Diss.Org. N (µg/L) | Part. N (µg/L) | Total N (µg/L) | Diss. TN (µg/L) | SRP (µg/L) | Diss.Org. P (µg/L) | Part. P (µg/L) | Total P (µg/L) | Diss. TP (µg/L) | Turbidity (NTU) | Color (Pt-Co) | Chyl-a (µg/L) | |
|-----------------|----------|----------------|-------------------|------------------|--------------|--------------------|----------------|----------------|-----------------|------------|--------------------|----------------|----------------|-----------------|-----------------|---------------|---------------|------|
| 1435 | | 5/5/20 | 139 | 3 | 13 | 587 | 70 | 673 | 603 | 36 | 21 | 18 | 75 | 57 | 4.6 | 6 | 6.1 | |
| 1622 | | 5/26/20 | 140 | 11 | 12 | 477 | 116 | 616 | 500 | 55 | 31 | 49 | 135 | 86 | 2.3 | 10 | 12.2 | |
| 2083 | M-9 | 6/29/20 | 141 | 18 | 2 | 493 | 98 | 611 | 513 | 66 | 17 | 19 | 102 | 83 | 3.3 | 12 | 20.5 | |
| 2419 | | 7/27/20 | 128 | 3 | 2 | 416 | 219 | 640 | 421 | 87 | 10 | 21 | 118 | 97 | 2.1 | 14 | 15.5 | |
| 2838 | | 8/31/20 | 130 | 3 | 2 | 411 | 116 | 532 | 416 | 59 | 14 | 19 | 92 | 73 | 1.3 | 14 | 20.2 | |
| 3117 | | 9/23/20 | 132 | 15 | 2 | 453 | 52 | 522 | 470 | 79 | 25 | 58 | 162 | 104 | 1.8 | 27 | 17.6 | |
| Minimum Value: | | | 128 | 3 | 2 | 411 | 52 | 522 | 416 | 36 | 10 | 18 | 75 | 57 | 1 | 6 | 6.1 | |
| Maximum Value: | | | 141 | 18 | 13 | 587 | 219 | 673 | 603 | 87 | 31 | 58 | 162 | 104 | 82 | 5 | 27 | 20.5 |
| Geometric Mean: | | | 135 | 7 | 4 | 469 | 101 | 596 | 483 | 61 | 18 | 27 | 110 | 82 | 2 | 12 | 14.3 | |
| | | | | | | | | | | | | | | | | | | |
| 1405 | | 4/29/20 | 122 | 3 | 10 | 401 | 192 | 606 | 414 | 42 | 27 | 18 | 87 | 69 | 2.5 | 6 | 15.7 | |
| 1625 | | 5/27/20 | 140 | 12 | 13 | 593 | 77 | 695 | 618 | 58 | 24 | 11 | 93 | 82 | 2.2 | 9 | 10.7 | |
| 2084 | M-10 | 6/29/20 | 144 | 3 | 2 | 456 | 30 | 491 | 461 | 66 | 26 | 20 | 112 | 92 | 2.1 | 8 | 13.0 | |
| 2420 | | 7/27/20 | 121 | 3 | 2 | 302 | 321 | 628 | 307 | 25 | 35 | 21 | 81 | 60 | 1.6 | 11 | 15.0 | |
| 2839 | | 8/31/20 | 137 | 3 | 2 | 461 | 57 | 523 | 466 | 28 | 33 | 13 | 74 | 61 | 0.5 | 14 | 13.5 | |
| 3118 | | 9/23/20 | 136 | 3 | 2 | 521 | 60 | 586 | 526 | 50 | 38 | 33 | 121 | 88 | 0.9 | 16 | 20.5 | |
| Minimum Value: | | | 121 | 3 | 2 | 302 | 30 | 491 | 307 | 25 | 24 | 11 | 74 | 60 | 1 | 6 | 10.7 | |
| Maximum Value: | | | 144 | 12 | 13 | 593 | 321 | 695 | 618 | 66 | 38 | 33 | 121 | 92 | 82 | 3 | 16 | 20.5 |
| Geometric Mean: | | | 133 | 4 | 4 | 446 | 89 | 584 | 455 | 42 | 30 | 18 | 93 | 74 | 1 | 10 | 14.4 | |
| | | | | | | | | | | | | | | | | | | |
| 1395 | | 4/29/20 | 138 | 3 | 11 | 290 | 289 | 593 | 304 | 40 | 20 | 22 | 82 | 60 | 2.0 | 3 | 17.2 | |
| 1434 | | 5/27/20 | 132 | 3 | 7 | 140 | 442 | 592 | 150 | 51 | 23 | 115 | 189 | 74 | 0.9 | 19 | 7.1 | |
| 2124 | M-11 | 6/29/20 | 130 | 3 | 2 | 486 | 123 | 614 | 491 | 55 | 18 | 10 | 83 | 73 | 0.9 | 8 | 15.4 | |
| 2427 | | 7/28/20 | 135 | 3 | 11 | 263 | 62 | 339 | 277 | 52 | 26 | 24 | 102 | 78 | 1.4 | 6 | 10.2 | |
| 2845 | | 8/31/20 | 133 | 3 | 2 | 446 | 93 | 544 | 451 | 42 | 21 | 13 | 76 | 63 | 0.4 | 9 | 32.5 | |
| 3123 | | 9/24/20 | 129 | 3 | 2 | 457 | 45 | 507 | 462 | 50 | 71 | 27 | 148 | 121 | 1.2 | 8 | 17.9 | |
| Minimum Value: | | | 129 | 3 | 2 | 140 | 45 | 339 | 150 | 40 | 18 | 10 | 76 | 60 | 0 | 3 | 7.1 | |
| Maximum Value: | | | 138 | 3 | 11 | 486 | 442 | 614 | 491 | 55 | 71 | 115 | 189 | 121 | 2 | 19 | 32.5 | |
| Geometric Mean: | | | 133 | 3 | 4 | 319 | 126 | 522 | 330 | 48 | 26 | 24 | 107 | 76 | 1 | 8 | 14.9 | |
| | | | | | | | | | | | | | | | | | | |
| 1436 | | 5/5/20 | 144 | 3 | 6 | 655 | 90 | 754 | 664 | 39 | 13 | 15 | 67 | 52 | 1.3 | 10 | 10.2 | |
| 1623 | | 5/26/20 | 138 | 11 | 14 | 631 | 225 | 881 | 656 | 57 | 27 | 86 | 170 | 84 | 1.8 | 9 | 19.7 | |
| 2085 | M-12 | 6/29/20 | 140 | 31 | 2 | 480 | 52 | 565 | 513 | 63 | 12 | 8 | 83 | 75 | 1.8 | 14 | 3.4 | |
| 2421 | | 7/27/20 | 145 | 3 | 13 | 322 | 168 | 506 | 338 | 57 | 26 | 30 | 113 | 83 | 1.3 | 14 | 29.5 | |
| 2840 | | 8/31/20 | 136 | 3 | 2 | 453 | 87 | 545 | 458 | 40 | 20 | 12 | 72 | 60 | 0.5 | 14 | 26.2 | |
| 3119 | | 9/23/20 | 141 | 3 | 2 | 471 | 132 | 608 | 476 | 48 | 25 | 17 | 90 | 73 | 1.9 | 21 | 24.4 | |
| Minimum Value: | | | 136 | 3 | 2 | 322 | 52 | 506 | 338 | 39 | 12 | 8 | 67 | 52 | 1 | 9 | 3.4 | |
| Maximum Value: | | | 145 | 31 | 14 | 655 | 225 | 881 | 664 | 63 | 27 | 86 | 170 | 84 | 2 | 21 | 29.5 | |
| Geometric Mean: | | | 141 | 5 | 5 | 489 | 113 | 631 | 504 | 50 | 19 | 20 | 94 | 70 | 1 | 13 | 15.3 | |

Water Quality Characteristics of Surface Water Samples Collected at Marco Island from April - September 2020

| Lab ID | Location | Date Collected | Alkalinity (mg/L) | Ammonia N (µg/L) | NOx-N (µg/L) | Diss.Org. N (µg/L) | Part. N (µg/L) | Total N (µg/L) | Diss. TN (µg/L) | SRP (µg/L) | Diss.Org. P (µg/L) | Part. P (µg/L) | Total P (µg/L) | Diss. TP (µg/L) | Turbidity (NTU) | Color (Pt-Co) | Chyl-a (µg/L) |
|-----------------|----------|----------------|-------------------|------------------|--------------|--------------------|----------------|----------------|-----------------|------------|--------------------|----------------|----------------|-----------------|-----------------|---------------|---------------|
| 1437 | | 5/5/20 | 150 | 242 | 13 | 504 | 357 | 1,116 | 759 | 36 | 16 | 35 | 87 | 52 | 3.9 | 11 | 10.9 |
| 1626 | | 5/27/20 | 139 | 3 | 14 | 545 | 271 | 833 | 562 | 56 | 18 | 42 | 116 | 74 | 5.4 | 12 | 28.7 |
| 2086 | M-13 | 6/29/20 | 146 | 3 | 2 | 415 | 105 | 525 | 420 | 64 | 38 | 45 | 147 | 102 | 2.0 | 15 | 12.9 |
| 2423 | | 7/27/20 | 131 | 3 | 2 | 487 | 245 | 737 | 492 | 36 | 15 | 17 | 68 | 51 | 2.0 | 15 | 20.7 |
| 2841 | | 8/31/20 | 127 | 3 | 2 | 476 | 59 | 540 | 481 | 30 | 30 | 15 | 75 | 60 | 0.6 | 16 | 26.0 |
| 3120 | | 9/23/20 | 140 | 3 | 2 | 544 | 34 | 583 | 549 | 25 | 20 | 57 | 102 | 45 | 1.5 | 24 | 20.7 |
| Minimum Value: | | | 127 | 3 | 2 | 415 | 34 | 525 | 420 | 25 | 15 | 15 | 68 | 45 | 1 | 11 | 10.9 |
| Maximum Value: | | | 150 | 242 | 14 | 545 | 357 | 1,116 | 759 | 64 | 38 | 57 | 147 | 102 | 5 | 24 | 28.7 |
| Geometric Mean: | | | 139 | 6 | 4 | 493 | 131 | 696 | 534 | 39 | 21 | 31 | 96 | 61 | 2 | 15 | 18.9 |
| | | | | | | | | | | | | | | | | | |
| 1398 | | 4/29/20 | 131 | 3 | 5 | 584 | 63 | 655 | 592 | 33 | 24 | 49 | 106 | 57 | 4.3 | 5 | 16.6 |
| 1629 | | 5/27/20 | 140 | 12 | 12 | 606 | 223 | 853 | 630 | 52 | 22 | 77 | 151 | 74 | 1.8 | 10 | 16.8 |
| 1399 | M-14 | 6/29/20 | 132 | 3 | 16 | 597 | 129 | 745 | 616 | 32 | 25 | 31 | 88 | 57 | 3.7 | 5 | 18.5 |
| 2429 | | 7/28/20 | 136 | 3 | 9 | 545 | 133 | 690 | 557 | 43 | 35 | 17 | 95 | 78 | 2.1 | 4 | 23.6 |
| 2847 | | 8/31/20 | 135 | 3 | 2 | 493 | 86 | 584 | 498 | 45 | 23 | 11 | 79 | 68 | 0.6 | 11 | 7.3 |
| 3127 | | 9/24/20 | 130 | 3 | 2 | 491 | 123 | 614 | 491 | 38 | 35 | 10 | 83 | 73 | 0.9 | 8 | 15.4 |
| | | | | | | | | | | | | | | | | | |
| Minimum Value: | | | 131 | 3 | 2 | 493 | 63 | 584 | 498 | 32 | 22 | 11 | 79 | 57 | 1 | 4 | 7.3 |
| Maximum Value: | | | 140 | 12 | 16 | 606 | 223 | 853 | 630 | 52 | 35 | 77 | 151 | 78 | 4 | 11 | 23.6 |
| Geometric Mean: | | | 135 | 4 | 7 | 563 | 116 | 700 | 577 | 40 | 25 | 29 | 101 | 66 | 2 | 6 | 15.5 |
| | | | | | | | | | | | | | | | | | |
| 1397 | | 4/29/20 | 144 | 3 | 2 | 499 | 134 | 638 | 504 | 35 | 7 | 8 | 50 | 42 | 5.1 | 3 | 16.0 |
| 1630 | | 5/27/20 | 128 | 3 | 14 | 612 | 122 | 751 | 629 | 55 | 10 | 119 | 184 | 65 | 3.5 | 22 | 16.5 |
| 2093 | M-15 | 6/30/20 | 135 | 3 | 2 | 470 | 51 | 526 | 475 | 41 | 17 | 37 | 95 | 58 | 2.8 | 5 | 12.0 |
| 2430 | | 7/28/20 | 136 | 3 | 2 | 340 | 19 | 364 | 345 | 67 | 19 | 17 | 103 | 86 | 1.9 | 4 | 16.2 |
| 2848 | | 8/31/20 | 138 | 3 | 2 | 433 | 58 | 496 | 438 | 52 | 20 | 17 | 89 | 72 | 2.4 | 10 | 11.4 |
| 3127 | | 9/24/20 | 140 | 3 | 2 | 497 | 14 | 516 | 502 | 45 | 26 | 13 | 84 | 71 | 1.0 | 9 | 16.4 |
| | | | | | | | | | | | | | | | | | |
| Minimum Value: | | | 128 | 3 | 2 | 340 | 14 | 364 | 345 | 35 | 7 | 8 | 50 | 42 | 1 | 3 | 11 |
| Maximum Value: | | | 144 | 3 | 14 | 612 | 134 | 751 | 629 | 67 | 26 | 119 | 184 | 86 | 5 | 22 | 17 |
| Geometric Mean: | | | 137 | 3 | 3 | 468 | 48 | 535 | 475 | 48 | 15 | 23 | 94 | 64 | 2 | 7 | 15 |
| | | | | | | | | | | | | | | | | | |
| 1394 | | 4/29/20 | 145 | 3 | 6 | 318 | 132 | 459 | 327 | 38 | 29 | 9 | 76 | 67 | 6.6 | 2 | 12.7 |
| 1633 | | 5/27/20 | 135 | 13 | 7 | 417 | 230 | 667 | 437 | 57 | 19 | 25 | 101 | 76 | 2.3 | 12 | 11.3 |
| 2094 | M-16 | 6/30/20 | 131 | 18 | 2 | 359 | 100 | 479 | 379 | 68 | 13 | 17 | 98 | 81 | 3.2 | 3 | 7.9 |
| 2431 | | 7/28/20 | 140 | 3 | 2 | 224 | 43 | 272 | 229 | 56 | 17 | 7 | 80 | 73 | 1.9 | 7 | 15.6 |
| 2849 | | 8/31/20 | 138 | 3 | 2 | 398 | 46 | 449 | 403 | 40 | 18 | 54 | 112 | 58 | 1.5 | 7 | 11.7 |
| 3128 | | 9/24/20 | 139 | 3 | 2 | 518 | 137 | 660 | 523 | 35 | 22 | 25 | 82 | 57 | 0.8 | 8 | 16.0 |
| | | | | | | | | | | | | | | | | | |
| Minimum Value: | | | 131 | 3 | 2 | 224 | 43 | 272 | 229 | 35 | 13 | 7 | 76 | 57 | 1 | 2 | 8 |
| Maximum Value: | | | 145 | 18 | 7 | 518 | 230 | 667 | 523 | 68 | 29 | 54 | 112 | 81 | 7 | 12 | 16 |
| Geometric Mean: | | | 138 | 5 | 3 | 361 | 97 | 477 | 371 | 48 | 19 | 18 | 91 | 68 | 2 | 6 | 12 |

Water Quality Characteristics of Surface Water Samples Collected at Marco Island from April - September 2020

| Lab ID | Location | Date Collected | Alkalinity (mg/L) | Ammonia N (µg/L) | NOx-N (µg/L) | Diss.Org. N (µg/L) | Part. N (µg/L) | Total N (µg/L) | Diss. TN (µg/L) | SRP (µg/L) | Diss.Org. P (µg/L) | Part. P (µg/L) | Total P (µg/L) | Diss. TP (µg/L) | Turbidity (NTU) | Color (Pt-Co) | Chyl-a (µg/L) |
|-----------------|----------|----------------|-------------------|------------------|--------------|--------------------|----------------|----------------|-----------------|------------|--------------------|----------------|----------------|-----------------|-----------------|---------------|---------------|
| 1396 | | 4/29/20 | 138 | 3 | 10 | 560 | 69 | 642 | 573 | 35 | 7 | 27 | 69 | 42 | 5.2 | 3 | 11.2 |
| 1631 | | 5/27/20 | 130 | 13 | 13 | 938 | 293 | 1,257 | 964 | 55 | 17 | 32 | 104 | 72 | 3.8 | 21 | 10.4 |
| 2096 | M-17 | 6/30/20 | 137 | 3 | 2 | 407 | 35 | 447 | 412 | 65 | 18 | 57 | 140 | 83 | 3.5 | 4 | 7.3 |
| 2432 | | 7/28/20 | 137 | 3 | 2 | 283 | 119 | 407 | 288 | 87 | 22 | 15 | 124 | 109 | 3.9 | 6 | 10.6 |
| 2850 | | 8/31/20 | 137 | 3 | 2 | 415 | 73 | 493 | 420 | 44 | 26 | 23 | 93 | 70 | 1.4 | 7 | 5.4 |
| 3129 | | 9/24/20 | 136 | 3 | 2 | 485 | 60 | 550 | 490 | 41 | 25 | 16 | 82 | 66 | 2.6 | 5 | 15.6 |
| Minimum Value: | | | 130 | 3 | 2 | 283 | 35 | 407 | 288 | 35 | 7 | 15 | 69 | 42 | 1 | 3 | 5 |
| Maximum Value: | | | 138 | 13 | 13 | 938 | 293 | 1257 | 964 | 87 | 26 | 57 | 140 | 109 | 5 | 21 | 16 |
| Geometric Mean: | | | 136 | 4 | 4 | 480 | 85 | 584 | 488 | 52 | 18 | 25 | 99 | 71 | 3 | 6 | 10 |

1 Denotes value < MDL; MDL value is listed

APPENDIX C

PHOTOGRAPHS OF SEDIMENT CORE SAMPLES COLLECTED IN MARCO ISLAND WATERWAYS

Marco Island Sediment Photos Sites 1 - 4



Site 1



Site 2



Site 3



Site 4

Marco Island Sediment Photos Sites 5 - 8



Site 5



Site 6



Site 7



Site 8

Marco Island Sediment Photos Sites 9 - 12



Site 9



Site 10



Site 11



Site 12

Marco Island Sediment Photos Sites 13 - 16



Site 13



Site 14



Site 15



Site 16

Marco Island Sediment Photos Sites 17 - 20



Site 17



Site 18



Site 19



Site 20

Marco Island Sediment Photos

Sites 21 - 24



Site 21



Site 22



Site 23



Site 24

Marco Island Sediment Photos

Sites 25 - 26



Site 25



Site 26

APPENDIX D

HYDROLOGIC MODELING USED TO CALCULATE RUNOFF VOLUMES FOR MARCO ISLAND SUB-BASINS 1-5

ERD Methodology Runoff Model (Harper and Baker, 2007)

Project Name:

Marco Island

User Inputs

Basin Name:

1, 2, 3, 4, 5, 6, 7

Calc. Values

Meteorological Zone:

4

Annual Rainfall (inches):

53.3

| Sub Basin | Treatment 1 | Hydrologic Soil Group | Land Use | Area (ac.) | DCIA1 (%) | Non - DCIA CN Value2 | Runoff C Value4 | Generated Runoff Volume (ac-ft) | Runoff Volume Reduction Factor | Stormwater Reduction Volume (ac-ft) | Wetland Reduction Factor | Wetland Reduction Volume (ac-ft) | Delivered Runoff Volume (ac-ft) |
|-----------|-------------|-----------------------|-------------------------|------------|-----------|----------------------|-----------------|---------------------------------|--------------------------------|-------------------------------------|--------------------------|----------------------------------|---------------------------------|
| 1 | Direct | A | COASTAL SCRUB | 0.33 | 0.0 | 35.0 | 0.007 | 0.01 | 0.00 | 0.00 | 0.00 | 0.00 | 0.01 |
| 1 | Direct | A | COMMERCIAL | 11.99 | 49.7 | 71.3 | 0.448 | 23.87 | 0.00 | 0.00 | 0.00 | 0.00 | 23.87 |
| 1 | Direct | A | INSTITUTIONAL | 5.47 | 0.0 | 51.2 | 0.024 | 0.58 | 0.00 | 0.00 | 0.00 | 0.00 | 0.58 |
| 1 | Direct | A | MULTI-FAMILY | 40.53 | 0.1 | 72.9 | 0.086 | 15.52 | 0.00 | 0.00 | 0.00 | 0.00 | 15.52 |
| 1 | Direct | A | RECREATIONAL | 1.28 | 0.0 | 52.5 | 0.026 | 0.15 | 0.00 | 0.00 | 0.00 | 0.00 | 0.15 |
| 1 | Direct | A | SWIMMING BEACH | 0.23 | 0.0 | 77.0 | 0.109 | 0.11 | 0.00 | 0.00 | 0.00 | 0.00 | 0.11 |
| 1 | Direct | A | UPLAND HARDWOOD FORESTS | 0.03 | 0.0 | 32.0 | 0.005 | 0.00 | 0.00 | 0.00 | 0.00 | 0.00 | 0.00 |
| 1 | Direct | A | VACANT NONRESIDENTIAL | 0.18 | 0.0 | 39.0 | 0.010 | 0.01 | 0.00 | 0.00 | 0.00 | 0.00 | 0.01 |
| 1 | Direct | A/D | COASTAL SCRUB | 2.28 | 0.0 | 77.0 | 0.109 | 1.11 | 0.00 | 0.00 | 0.00 | 0.00 | 1.11 |
| 1 | Direct | A/D | MULTI-FAMILY | 1.56 | 0.0 | 62.0 | 0.046 | 0.32 | 0.00 | 0.00 | 0.00 | 0.00 | 0.32 |
| 1 | Direct | A/D | RECREATIONAL | 2.70 | 0.0 | 85.2 | 0.185 | 2.22 | 0.00 | 0.00 | 0.00 | 0.00 | 2.22 |
| 1 | Direct | A/D | UPLAND HARDWOOD FORESTS | 7.79 | 0.0 | 79.0 | 0.123 | 4.26 | 0.00 | 0.00 | 0.00 | 0.00 | 4.26 |
| 1 | Direct | D | MANGROVE SWAMPS | 83.36 | 0.0 | 87.0 | 0.215 | 79.78 | 0.00 | 0.00 | 0.00 | 0.00 | 79.78 |
| 1 | Dry Pond | A | COASTAL SCRUB | 1.75 | 0.0 | 35.0 | 0.007 | 0.05 | 0.80 | 0.04 | 0.00 | 0.00 | 0.01 |
| 1 | Dry Pond | A | COMMERCIAL | 36.30 | 3.7 | 86.5 | 0.230 | 37.05 | 0.80 | 29.84 | 0.00 | 0.00 | 7.41 |
| 1 | Dry Pond | A | DRY PONDS | 3.71 | 0.0 | 39.0 | 0.010 | 0.17 | 0.80 | 0.13 | 0.00 | 0.00 | 0.03 |
| 1 | Dry Pond | A | INSTITUTIONAL | 11.16 | 0.2 | 76.4 | 0.107 | 5.28 | 0.80 | 4.23 | 0.00 | 0.00 | 1.06 |
| 1 | Dry Pond | A | MDR | 0.92 | 0.0 | 70.0 | 0.071 | 0.29 | 0.80 | 0.23 | 0.00 | 0.00 | 0.06 |
| 1 | Dry Pond | A | MULTI-FAMILY | 49.81 | 0.4 | 77.0 | 0.112 | 24.81 | 0.80 | 19.85 | 0.00 | 0.00 | 4.96 |
| 1 | Dry Pond | A | RECREATIONAL | 3.70 | 0.2 | 61.1 | 0.045 | 0.74 | 0.80 | 0.59 | 0.00 | 0.00 | 0.15 |
| 1 | Dry Pond | A/D | COASTAL SCRUB | 1.88 | 0.0 | 77.0 | 0.109 | 0.91 | 0.80 | 0.73 | 0.00 | 0.00 | 0.18 |
| 1 | Dry Pond | A/D | DRY PONDS | 1.92 | 0.0 | 39.0 | 0.010 | 0.09 | 0.80 | 0.07 | 0.00 | 0.00 | 0.02 |
| 1 | Dry Pond | A/D | MDR | 0.14 | 0.0 | 70.4 | 0.073 | 0.05 | 0.80 | 0.04 | 0.00 | 0.00 | 0.01 |
| 1 | Dry Pond | A/D | MULTI-FAMILY | 21.28 | 0.0 | 72.5 | 0.084 | 7.89 | 0.80 | 6.32 | 0.00 | 0.00 | 1.58 |
| 1 | Dry Pond | A/D | UPLAND HARDWOOD FORESTS | 2.99 | 0.0 | 79.0 | 0.123 | 1.63 | 0.80 | 1.31 | 0.00 | 0.00 | 0.33 |
| 1 | None | W | WATERWAYS | 565.51 | 0.0 | 98.0 | 0.616 | 1546.06 | 0.00 | 0.00 | 0.00 | 0.00 | 1546.06 |
| 1 | Pond | A | MDR | 1.54 | 0.0 | 70.7 | 0.075 | 0.51 | 0.20 | 0.10 | 0.00 | 0.00 | 0.41 |
| 1 | Pond | A | UPLAND HARDWOOD FORESTS | 1.19 | 0.0 | 32.0 | 0.005 | 0.03 | 0.20 | 0.01 | 0.00 | 0.00 | 0.02 |
| 1 | Pond | A/D | COASTAL SCRUB | 1.18 | 0.0 | 77.0 | 0.109 | 0.57 | 0.20 | 0.11 | 0.00 | 0.00 | 0.46 |
| 1 | Pond | A/D | MDR | 0.84 | 0.0 | 69.4 | 0.069 | 0.26 | 0.20 | 0.05 | 0.00 | 0.00 | 0.21 |
| 1 | Pond | A/D | UPLAND HARDWOOD FORESTS | 0.62 | 0.0 | 79.0 | 0.123 | 0.34 | 0.20 | 0.07 | 0.00 | 0.00 | 0.27 |
| 1 | Pond | D | MANGROVE SWAMPS | 2.66 | 0.0 | 87.0 | 0.215 | 2.55 | 0.20 | 0.51 | 0.00 | 0.00 | 2.04 |
| 1 | Swale | A | CEMETERIES | 2.43 | 0.0 | 47.8 | 0.019 | 0.21 | 0.20 | 0.04 | 0.00 | 0.00 | 0.17 |
| 1 | Swale | A | COASTAL SCRUB | 4.88 | 0.0 | 35.0 | 0.007 | 0.15 | 0.20 | 0.03 | 0.00 | 0.00 | 0.12 |
| 1 | Swale | A | COMMERCIAL | 111.65 | 12.8 | 77.6 | 0.204 | 101.28 | 0.20 | 20.26 | 0.00 | 0.00 | 81.02 |
| 1 | Swale | A | DRY PONDS | 0.08 | 0.0 | 39.0 | 0.010 | 0.00 | 0.20 | 0.00 | 0.00 | 0.00 | 0.00 |
| 1 | Swale | A | INSTITUTIONAL | 7.17 | 9.9 | 55.9 | 0.110 | 3.51 | 0.20 | 0.70 | 0.00 | 0.00 | 2.81 |
| 1 | Swale | A | MDR | 556.67 | 0.1 | 67.0 | 0.062 | 152.44 | 0.20 | 30.49 | 0.00 | 0.00 | 121.95 |
| 1 | Swale | A | MULTI-FAMILY | 140.42 | 0.6 | 75.9 | 0.106 | 66.15 | 0.20 | 13.23 | 0.00 | 0.00 | 52.92 |
| 1 | Swale | A | RECREATIONAL | 29.59 | 0.0 | 39.6 | 0.010 | 1.37 | 0.20 | 0.27 | 0.00 | 0.00 | 1.10 |
| 1 | Swale | A | UPLAND HARDWOOD FORESTS | 27.03 | 0.0 | 32.0 | 0.005 | 0.65 | 0.20 | 0.13 | 0.00 | 0.00 | 0.52 |

ERD Methodology Runoff Model (Harper and Baker, 2007)

Project Name:

Marco Island

User Inputs

Basin Name:

1, 2, 3, 4, 5, 6, 7

Calc. Values

Meteorological Zone:

4

Annual Rainfall (inches):

53.3

| Sub Basin | Treatment 1 | Hydrologic Soil Group | Land Use | Area (ac.) | DC/IA1 (%) | Non - DC/IA CN Value ² | Runoff C Value ⁴ | Generated Runoff Volume (ac-ft) | Runoff Volume Reduction Factor | Stormwater Reduction Volume (ac-ft) | Wetland Reduction Factor | Wetland Reduction Volume (ac-ft) | Delivered Runoff Volume (ac-ft) |
|-----------|---------------|-----------------------|--------------------------|------------|------------|-----------------------------------|-----------------------------|---------------------------------|--------------------------------|-------------------------------------|--------------------------|----------------------------------|---------------------------------|
| 1 | Swale | A | VACANT NONRESIDENTIAL | 6.96 | 0.0 | 39.0 | 0.010 | 0.31 | 0.20 | 0.06 | 0.00 | 0.00 | 0.25 |
| 1 | Swale | A/D | COASTAL SCRUB | 2.09 | 0.0 | 77.0 | 0.109 | 1.01 | 0.20 | 0.20 | 0.00 | 0.00 | 0.81 |
| 1 | Swale | A/D | MDR | 4.05 | 0.0 | 67.6 | 0.063 | 1.13 | 0.20 | 0.23 | 0.00 | 0.00 | 0.91 |
| 1 | Swale | A/D | MULTI-FAMILY | 0.68 | 0.0 | 62.8 | 0.048 | 0.14 | 0.20 | 0.03 | 0.00 | 0.00 | 0.12 |
| 1 | Swale | A/D | UPLAND HARDWOOD FORESTS | 0.74 | 0.0 | 79.0 | 0.123 | 0.40 | 0.20 | 0.08 | 0.00 | 0.00 | 0.32 |
| 1 | Swale | D | MANGROVE SWAMPS | 17.14 | 0.0 | 87.0 | 0.215 | 16.40 | 0.20 | 3.28 | 0.00 | 0.00 | 13.12 |
| 1 | Swale | W | ENCLOSED SALTWATER PONDS | 5.57 | 0.0 | 98.0 | 0.616 | 15.23 | 0.20 | 3.05 | 0.00 | 0.00 | 12.18 |
| 1 | Swale | W | PONDS | 4.92 | 0.0 | 98.0 | 0.616 | 13.45 | 0.20 | 2.69 | 0.00 | 0.00 | 10.76 |
| 1 | Swale-GC-Pond | A | MDR | 0.14 | 0.0 | 70.9 | 0.076 | 0.05 | 0.36 | 0.02 | 0.00 | 0.00 | 0.03 |
| 1 | Swale-GC-Pond | A/D | MDR | 0.04 | 0.0 | 69.1 | 0.088 | 0.01 | 0.36 | 0.00 | 0.00 | 0.00 | 0.01 |
| 1 | Wet Pond | A | CEMETERIES | 0.09 | 0.0 | 39.0 | 0.010 | 0.00 | 0.20 | 0.00 | 0.00 | 0.00 | 0.00 |
| 1 | Wet Pond | A | INSTITUTIONAL | 1.32 | 0.0 | 57.9 | 0.036 | 0.21 | 0.20 | 0.04 | 0.00 | 0.00 | 0.17 |
| 1 | Wet Pond | A | MDR | 0.05 | 0.0 | 69.1 | 0.068 | 0.02 | 0.20 | 0.00 | 0.00 | 0.00 | 0.01 |
| 1 | Wet Pond | A | MULTI-FAMILY | 8.91 | 0.0 | 73.9 | 0.090 | 3.57 | 0.20 | 0.71 | 0.00 | 0.00 | 2.86 |
| 1 | Wet Pond | W | PONDS | 1.43 | 0.0 | 98.0 | 0.616 | 3.91 | 0.20 | 0.78 | 0.00 | 0.00 | 3.13 |
| 1 | Wetland | A | CEMETERIES | 0.74 | 0.0 | 39.1 | 0.010 | 0.03 | 0.10 | 0.00 | 0.00 | 0.00 | 0.03 |
| 1 | Rear Swale | A | MDR | 250.24 | 0.0 | 65.2 | 0.055 | 60.62 | 0.95 | 57.58 | 0.00 | 0.00 | 3.03 |
| 1 | Rear Swale | A/D | MDR | 0.71 | 0.0 | 70.8 | 0.075 | 0.24 | 0.95 | 0.23 | 0.00 | 0.00 | 0.01 |

ERD Methodology Runoff Model (Harper and Baker, 2007)

Project Name:

Marco Island

User Inputs

Basin Name:

1, 2, 3, 4, 5, 6, 7

Calc. Values

Meteorological Zone:

4

Annual Rainfall (inches):

53.3

| Sub Basin | Treatment 1 | Hydrologic Soil Group | Land Use | Area (ac.) | DCIA1 (%) | Non - DCIA CN Value2 | Runoff C Value4 | Generated Runoff Volume (ac-ft) | Runoff Volume Reduction Factor | Stormwater Reduction Volume (ac-ft) | Wetland Reduction Factor | Wetland Reduction Volume (ac-ft) | Delivered Runoff Volume (ac-ft) |
|-----------|---------------|-----------------------|-----------------------|------------|-----------|----------------------|-----------------|---------------------------------|--------------------------------|-------------------------------------|--------------------------|----------------------------------|---------------------------------|
| 2 | Direct | A | COMMERCIAL | 6.55 | 38.1 | 90.0 | 0.478 | 13.92 | 0.00 | 0.00 | 0.00 | 0.00 | 13.92 |
| 2 | Direct | A | HIGHWAY | 0.09 | 26.3 | 39.0 | 0.224 | 0.09 | 0.00 | 0.00 | 0.00 | 0.00 | 0.09 |
| 2 | Direct | A | MARINAS | 1.31 | 0.0 | 74.2 | 0.092 | 0.53 | 0.00 | 0.00 | 0.00 | 0.00 | 0.53 |
| 2 | Direct | A | MULTI-FAMILY | 3.04 | 0.0 | 78.8 | 0.122 | 1.64 | 0.00 | 0.00 | 0.00 | 0.00 | 1.64 |
| 2 | Direct | A | RECREATIONAL | 1.22 | 0.0 | 39.0 | 0.010 | 0.05 | 0.00 | 0.00 | 0.00 | 0.00 | 0.05 |
| 2 | Direct | A | UTILITIES | 2.27 | 0.0 | 87.6 | 0.226 | 2.28 | 0.00 | 0.00 | 0.00 | 0.00 | 2.28 |
| 2 | Dry Pond | A | COMMERCIAL | 9.55 | 2.1 | 86.6 | 0.222 | 9.40 | 0.80 | 7.52 | 0.00 | 0.00 | 1.88 |
| 2 | Dry Pond | A | DRY PONDS | 0.34 | 0.0 | 39.0 | 0.010 | 0.02 | 0.80 | 0.01 | 0.00 | 0.00 | 0.00 |
| 2 | Dry Pond | A | HIGHWAY | 2.45 | 85.0 | 78.0 | 0.717 | 7.80 | 0.80 | 6.24 | 0.00 | 0.00 | 1.56 |
| 2 | Dry Pond | A | INSTITUTIONAL | 2.30 | 0.0 | 67.9 | 0.064 | 0.65 | 0.80 | 0.52 | 0.00 | 0.00 | 0.13 |
| 2 | Dry Pond | A | MARINAS | 3.29 | 0.0 | 74.1 | 0.091 | 1.33 | 0.80 | 1.07 | 0.00 | 0.00 | 0.27 |
| 2 | Dry Pond | A | MULTI-FAMILY | 7.25 | 0.0 | 87.8 | 0.229 | 7.38 | 0.80 | 5.90 | 0.00 | 0.00 | 1.48 |
| 2 | Dry Pond | A | RECREATIONAL | 0.01 | 0.0 | 39.0 | 0.010 | 0.00 | 0.80 | 0.00 | 0.00 | 0.00 | 0.00 |
| 2 | Dry Pond | A | UTILITIES | 5.33 | 0.0 | 89.7 | 0.261 | 6.19 | 0.80 | 4.95 | 0.00 | 0.00 | 1.24 |
| 2 | None | W | WATERWAYS | 75.65 | 0.0 | 98.0 | 0.616 | 206.82 | 0.00 | 0.00 | 0.00 | 0.00 | 206.82 |
| 2 | Pond | A | UTILITIES | 0.62 | 0.0 | 93.6 | 0.384 | 1.06 | 0.20 | 0.21 | 0.00 | 0.00 | 0.85 |
| 2 | Swale | A | COMMERCIAL | 33.74 | 2.2 | 85.5 | 0.204 | 30.56 | 0.20 | 6.11 | 0.00 | 0.00 | 24.45 |
| 2 | Swale | A | HIGHWAY | 6.58 | 7.6 | 80.1 | 0.183 | 5.36 | 0.20 | 1.07 | 0.00 | 0.00 | 4.29 |
| 2 | Swale | A | INSTITUTIONAL | 0.66 | 0.0 | 43.2 | 0.014 | 0.04 | 0.20 | 0.01 | 0.00 | 0.00 | 0.03 |
| 2 | Swale | A | MARINAS | 0.11 | 0.0 | 44.8 | 0.015 | 0.01 | 0.20 | 0.00 | 0.00 | 0.00 | 0.01 |
| 2 | Swale | A | MDR | 141.55 | 0.0 | 68.1 | 0.065 | 40.73 | 0.20 | 8.15 | 0.00 | 0.00 | 32.58 |
| 2 | Swale | A | RECREATIONAL | 0.23 | 0.0 | 55.7 | 0.032 | 0.03 | 0.20 | 0.01 | 0.00 | 0.00 | 0.03 |
| 2 | Swale | A | UTILITIES | 4.53 | 0.0 | 92.6 | 0.351 | 7.06 | 0.20 | 1.41 | 0.00 | 0.00 | 5.65 |
| 2 | Swale | A | VACANT NONRESIDENTIAL | 0.85 | 0.0 | 39.0 | 0.010 | 0.04 | 0.20 | 0.01 | 0.00 | 0.00 | 0.03 |
| 2 | Swale-GC-Pond | A | MDR | 2.99 | 0.0 | 66.2 | 0.058 | 0.77 | 0.36 | 0.28 | 0.00 | 0.00 | 0.49 |
| 2 | Rear Swale | A | MDR | 69.64 | 0.0 | 66.0 | 0.057 | 17.74 | 0.95 | 16.86 | 0.00 | 0.00 | 0.89 |

ERD Methodology Runoff Model (Harper and Baker, 2007)

Project Name:

Marco Island

User Inputs

Basin Name:

1, 2, 3, 4, 5, 6, 7

Calc. Values

Meteorological Zone:

4

Annual Rainfall (inches):

53.3

| Sub Basin | Treatment 1 | Hydrologic Soil Group | Land Use | Area (ac.) | DCIA1 (%) | Non - DCIA CN Value2 | Runoff C Value4 | Generated Runoff Volume (ac-ft) | Runoff Volume Reduction Factor | Stormwater Reduction Volume (ac-ft) | Wetland Reduction Factor | Wetland Reduction Volume (ac-ft) | Delivered Runoff Volume (ac-ft) |
|-----------|---------------|-----------------------|-------------------------|------------|-----------|----------------------|-----------------|---------------------------------|--------------------------------|-------------------------------------|--------------------------|----------------------------------|---------------------------------|
| 3 | Direct | A | HIGHWAY | 0.03 | 55.9 | 39.0 | 0.484 | 0.06 | 0.00 | 0.00 | 0.00 | 0.00 | 0.06 |
| 3 | Direct | A | RECREATIONAL | 2.19 | 0.0 | 41.3 | 0.012 | 0.12 | 0.00 | 0.00 | 0.00 | 0.00 | 0.12 |
| 3 | Direct | D | MANGROVE SWAMPS | 1.13 | 0.0 | 87.0 | 0.215 | 1.08 | 0.00 | 0.00 | 0.00 | 0.00 | 1.08 |
| 3 | Dry Pond | A | COMMERCIAL | 6.00 | 23.6 | 78.9 | 0.288 | 7.67 | 0.80 | 6.13 | 0.00 | 0.00 | 1.53 |
| 3 | Dry Pond | A | DRY PONDS | 1.55 | 0.0 | 39.0 | 0.010 | 0.07 | 0.80 | 0.06 | 0.00 | 0.00 | 0.01 |
| 3 | Dry Pond | A | HIGHWAY | 1.94 | 91.7 | 56.5 | 0.757 | 6.53 | 0.80 | 5.22 | 0.00 | 0.00 | 1.31 |
| 3 | Dry Pond | A | INSTITUTIONAL | 13.98 | 0.0 | 69.1 | 0.068 | 4.24 | 0.80 | 3.39 | 0.00 | 0.00 | 0.85 |
| 3 | Dry Pond | A | MDR | 3.79 | 0.0 | 65.9 | 0.057 | 0.96 | 0.80 | 0.77 | 0.00 | 0.00 | 0.19 |
| 3 | Dry Pond | A | MULTI-FAMILY | 0.44 | 0.0 | 70.9 | 0.076 | 0.15 | 0.80 | 0.12 | 0.00 | 0.00 | 0.03 |
| 3 | Dry Pond | A | RECREATIONAL | 0.53 | 0.0 | 39.0 | 0.010 | 0.02 | 0.80 | 0.02 | 0.00 | 0.00 | 0.00 |
| 3 | Golf Ponds | A | MDR | 40.68 | 0.0 | 68.1 | 0.065 | 11.70 | 0.20 | 2.34 | 0.00 | 0.00 | 9.36 |
| 3 | Golf Ponds | A | RECREATIONAL | 114.96 | 0.0 | 43.7 | 0.014 | 7.34 | 0.20 | 1.47 | 0.00 | 0.00 | 5.87 |
| 3 | Golf Ponds | W | PONDS | 33.47 | 0.0 | 98.0 | 0.616 | 91.50 | 0.20 | 18.30 | 0.00 | 0.00 | 73.20 |
| 3 | None | W | WATERWAYS | 227.87 | 0.0 | 98.0 | 0.616 | 622.98 | 0.00 | 0.00 | 0.00 | 0.00 | 622.98 |
| 3 | Pond | A | COMMERCIAL | 6.63 | 56.4 | 81.8 | 0.529 | 15.58 | 0.20 | 3.12 | 0.00 | 0.00 | 12.46 |
| 3 | Pond | A | MDR | 1.81 | 0.0 | 60.9 | 0.043 | 0.34 | 0.20 | 0.07 | 0.00 | 0.00 | 0.28 |
| 3 | Pond | A | MULTI-FAMILY | 1.54 | 0.1 | 77.7 | 0.115 | 0.79 | 0.20 | 0.16 | 0.00 | 0.00 | 0.63 |
| 3 | Pond | A | RECREATIONAL | 1.00 | 0.0 | 39.0 | 0.010 | 0.04 | 0.20 | 0.01 | 0.00 | 0.00 | 0.04 |
| 3 | Pond | A | VACANT NONRESIDENTIAL | 0.40 | 0.0 | 39.0 | 0.010 | 0.02 | 0.20 | 0.00 | 0.00 | 0.00 | 0.01 |
| 3 | Pond | A/D | COMMERCIAL | 0.07 | 0.0 | 89.7 | 0.261 | 0.08 | 0.20 | 0.02 | 0.00 | 0.00 | 0.06 |
| 3 | Pond | A/D | MDR | 0.82 | 0.0 | 69.1 | 0.068 | 0.25 | 0.20 | 0.05 | 0.00 | 0.00 | 0.20 |
| 3 | Pond | A/D | MULTI-FAMILY | 0.58 | 0.0 | 72.9 | 0.085 | 0.22 | 0.20 | 0.04 | 0.00 | 0.00 | 0.18 |
| 3 | Pond | A/D | VACANT NONRESIDENTIAL | 0.84 | 0.0 | 39.0 | 0.010 | 0.04 | 0.20 | 0.01 | 0.00 | 0.00 | 0.03 |
| 3 | Pond | W | PONDS | 4.29 | 0.0 | 98.0 | 0.616 | 11.73 | 0.20 | 2.35 | 0.00 | 0.00 | 9.38 |
| 3 | Pond | W | WET PONDS | 0.60 | 0.0 | 98.0 | 0.616 | 1.64 | 0.20 | 0.33 | 0.00 | 0.00 | 1.31 |
| 3 | Swale | A | COMMERCIAL | 7.19 | 12.0 | 74.8 | 0.182 | 5.81 | 0.20 | 1.16 | 0.00 | 0.00 | 4.65 |
| 3 | Swale | A | HIGHWAY | 1.63 | 22.8 | 77.2 | 0.273 | 1.98 | 0.20 | 0.40 | 0.00 | 0.00 | 1.58 |
| 3 | Swale | A | INSTITUTIONAL | 8.87 | 0.0 | 71.5 | 0.079 | 3.10 | 0.20 | 0.62 | 0.00 | 0.00 | 2.48 |
| 3 | Swale | A | MDR | 374.28 | 0.0 | 68.0 | 0.064 | 107.10 | 0.20 | 21.42 | 0.00 | 0.00 | 85.68 |
| 3 | Swale | A | RECREATIONAL | 5.90 | 0.0 | 60.6 | 0.042 | 1.10 | 0.20 | 0.22 | 0.00 | 0.00 | 0.88 |
| 3 | Swale | A | UPLAND HARDWOOD FORESTS | 0.26 | 0.0 | 32.0 | 0.005 | 0.01 | 0.20 | 0.00 | 0.00 | 0.00 | 0.01 |
| 3 | Swale | A | VACANT NONRESIDENTIAL | 1.06 | 0.0 | 39.0 | 0.010 | 0.05 | 0.20 | 0.01 | 0.00 | 0.00 | 0.04 |
| 3 | Swale-GC-Pond | A | MDR | 67.93 | 0.0 | 69.1 | 0.068 | 20.61 | 0.36 | 7.42 | 0.00 | 0.00 | 13.19 |
| 3 | Swale-GC-Pond | A | RECREATIONAL | 0.23 | 0.0 | 48.8 | 0.020 | 0.02 | 0.36 | 0.01 | 0.00 | 0.00 | 0.01 |
| 3 | Swale-GC-Pond | A/D | MDR | 0.05 | 0.0 | 69.1 | 0.068 | 0.02 | 0.36 | 0.01 | 0.00 | 0.00 | 0.01 |
| 3 | Swale-Pond | A | COMMERCIAL | 0.01 | 0.0 | 98.0 | 0.616 | 0.03 | 0.36 | 0.01 | 0.00 | 0.00 | 0.02 |
| 3 | Swale-Pond | A | MDR | 10.52 | 0.0 | 66.1 | 0.058 | 2.70 | 0.36 | 0.97 | 0.00 | 0.00 | 1.73 |
| 3 | Swale-Pond | A | MULTI-FAMILY | 3.81 | 0.2 | 60.0 | 0.042 | 0.71 | 0.36 | 0.26 | 0.00 | 0.00 | 0.45 |
| 3 | Rear Swale | A | MDR | 214.43 | 0.0 | 65.2 | 0.055 | 51.94 | 0.95 | 49.34 | 0.00 | 0.00 | 2.60 |

ERD Methodology Runoff Model (Harper and Baker, 2007)

Project Name:

Marco Island

User Inputs

Basin Name:

1, 2, 3, 4, 5, 6, 7

Calc. Values

Meteorological Zone:

4

Annual Rainfall (inches):

53.3

| Sub Basin | Treatment 1 | Hydrologic Soil Group | Land Use | Area (ac.) | DCIA1 (%) | Non - DCIA CN Value2 | Runoff C Value4 | Generated Runoff Volume (ac-ft) | Runoff Volume Reduction Factor | Stormwater Reduction Volume (ac-ft) | Wetland Reduction Factor | Wetland Reduction Volume (ac-ft) | Delivered Runoff Volume (ac-ft) |
|-----------|-------------|-----------------------|-----------------------|------------|-----------|----------------------|-----------------|---------------------------------|--------------------------------|-------------------------------------|--------------------------|----------------------------------|---------------------------------|
| 4 | Direct | A | COMMERCIAL | 14.14 | 67.6 | 62.0 | 0.571 | 35.88 | 0.00 | 0.00 | 0.00 | 0.00 | 35.88 |
| 4 | Direct | A | MULTI-FAMILY | 18.22 | 0.0 | 75.1 | 0.096 | 7.79 | 0.00 | 0.00 | 0.00 | 0.00 | 7.79 |
| 4 | Direct | A/D | MULTI-FAMILY | 0.55 | 0.0 | 73.2 | 0.087 | 0.21 | 0.00 | 0.00 | 0.00 | 0.00 | 0.21 |
| 4 | Dry Pond | A | COASTAL SCRUB | 15.11 | 0.0 | 35.0 | 0.007 | 0.47 | 0.80 | 0.38 | 0.00 | 0.00 | 0.09 |
| 4 | Dry Pond | A | COMMERCIAL | 16.83 | 58.9 | 66.9 | 0.510 | 38.10 | 0.80 | 30.48 | 0.00 | 0.00 | 7.62 |
| 4 | Dry Pond | A | DRY PONDS | 9.95 | 0.0 | 39.0 | 0.010 | 0.44 | 0.80 | 0.35 | 0.00 | 0.00 | 0.09 |
| 4 | Dry Pond | A | INSTITUTIONAL | 7.61 | 0.0 | 80.0 | 0.130 | 4.39 | 0.80 | 3.51 | 0.00 | 0.00 | 0.88 |
| 4 | Dry Pond | A | MDR | 0.05 | 0.0 | 69.1 | 0.068 | 0.02 | 0.80 | 0.01 | 0.00 | 0.00 | 0.00 |
| 4 | Dry Pond | A | MULTI-FAMILY | 227.21 | 2.8 | 75.3 | 0.118 | 119.02 | 0.80 | 95.21 | 0.00 | 0.00 | 23.80 |
| 4 | Dry Pond | A | RECREATIONAL | 10.64 | 0.0 | 69.0 | 0.088 | 3.21 | 0.80 | 2.57 | 0.00 | 0.00 | 0.64 |
| 4 | Dry Pond | A | SWIMMING BEACH | 1.25 | 0.0 | 77.0 | 0.109 | 0.61 | 0.80 | 0.49 | 0.00 | 0.00 | 0.12 |
| 4 | Dry Pond | A | VACANT NONRESIDENTIAL | 0.55 | 0.0 | 39.0 | 0.010 | 0.02 | 0.80 | 0.02 | 0.00 | 0.00 | 0.00 |
| 4 | Dry Pond | A/D | COASTAL SCRUB | 4.88 | 0.0 | 77.0 | 0.109 | 2.27 | 0.80 | 1.82 | 0.00 | 0.00 | 0.45 |
| 4 | Dry Pond | A/D | DRY PONDS | 0.11 | 0.0 | 39.0 | 0.010 | 0.00 | 0.80 | 0.00 | 0.00 | 0.00 | 0.00 |
| 4 | Dry Pond | A/D | MULTI-FAMILY | 0.21 | 0.0 | 77.3 | 0.111 | 0.10 | 0.80 | 0.08 | 0.00 | 0.00 | 0.02 |
| 4 | None | W | WATERWAYS | 374.28 | 0.0 | 98.0 | 0.616 | 1023.25 | 0.00 | 0.00 | 0.00 | 0.00 | 1023.25 |
| 4 | Swale | A | COMMERCIAL | 43.90 | 12.1 | 75.6 | 0.187 | 36.50 | 0.20 | 7.30 | 0.00 | 0.00 | 29.20 |
| 4 | Swale | A | HDR | 0.99 | 9.3 | 39.0 | 0.086 | 0.38 | 0.20 | 0.08 | 0.00 | 0.00 | 0.30 |
| 4 | Swale | A | INSTITUTIONAL | 3.61 | 0.0 | 54.5 | 0.029 | 0.47 | 0.20 | 0.09 | 0.00 | 0.00 | 0.38 |
| 4 | Swale | A | MDR | 363.92 | 0.0 | 67.6 | 0.063 | 101.85 | 0.20 | 20.37 | 0.00 | 0.00 | 81.48 |
| 4 | Swale | A | MULTI-FAMILY | 17.81 | 0.0 | 77.3 | 0.111 | 8.81 | 0.20 | 1.76 | 0.00 | 0.00 | 7.05 |
| 4 | Swale | A | RECREATIONAL | 3.57 | 0.0 | 45.2 | 0.016 | 0.25 | 0.20 | 0.05 | 0.00 | 0.00 | 0.20 |
| 4 | Swale | A | UTILITIES | 3.41 | 0.0 | 80.3 | 0.133 | 2.01 | 0.20 | 0.40 | 0.00 | 0.00 | 1.61 |
| 4 | Swale | A | VACANT NONRESIDENTIAL | 1.71 | 0.0 | 39.0 | 0.010 | 0.08 | 0.20 | 0.02 | 0.00 | 0.00 | 0.06 |
| 4 | Wet Pond | A | HDR | 8.69 | 25.7 | 62.9 | 0.247 | 9.55 | 0.20 | 1.91 | 0.00 | 0.00 | 7.64 |
| 4 | Wet Pond | W | PONDS | 2.67 | 0.0 | 98.0 | 0.616 | 7.30 | 0.20 | 1.46 | 0.00 | 0.00 | 5.84 |
| 4 | Rear Swale | A | MDR | 177.70 | 0.0 | 65.0 | 0.054 | 42.49 | 0.95 | 40.36 | 0.00 | 0.00 | 2.12 |

ERD Methodology Runoff Model (Harper and Baker, 2007)

Project Name:

Marco Island

User Inputs

Basin Name:

1, 2, 3, 4, 5, 6, 7

Calc. Values

Meteorological Zone:

4

Annual Rainfall (inches):

53.3

| Sub Basin | Treatment 1 | Hydrologic Soil Group | Land Use | Area (ac.) | DCIA1 (%) | Non - DCIA CN Value2 | Runoff C Value4 | Generated Runoff Volume (ac-ft) | Runoff Volume Reduction Factor | Stormwater Reduction Volume (ac-ft) | Wetland Reduction Factor | Wetland Reduction Volume (ac-ft) | Delivered Runoff Volume (ac-ft) |
|-----------|-------------|-----------------------|-------------------------|------------|-----------|----------------------|-----------------|---------------------------------|--------------------------------|-------------------------------------|--------------------------|----------------------------------|---------------------------------|
| 5 | Direct | A | INSTITUTIONAL | 0.53 | 0.0 | 40.0 | 0.011 | 0.03 | 0.00 | 0.00 | 0.00 | 0.00 | 0.03 |
| 5 | Direct | A | UPLAND HARDWOOD FORESTS | 0.98 | 0.0 | 32.0 | 0.005 | 0.02 | 0.00 | 0.00 | 0.00 | 0.00 | 0.02 |
| 5 | Direct | W | PONDS | 8.15 | 0.0 | 98.0 | 0.616 | 22.28 | 0.00 | 0.00 | 0.00 | 0.00 | 22.28 |
| 5 | Dry Pond | A | COMMERCIAL | 14.66 | 72.9 | 64.6 | 0.614 | 40.00 | 0.80 | 32.00 | 0.00 | 0.00 | 8.00 |
| 5 | Dry Pond | A | DRY PONDS | 0.55 | 0.0 | 39.0 | 0.010 | 0.02 | 0.80 | 0.02 | 0.00 | 0.00 | 0.00 |
| 5 | Dry Pond | A | INSTITUTIONAL | 8.35 | 0.0 | 69.0 | 0.068 | 2.52 | 0.80 | 2.02 | 0.00 | 0.00 | 0.50 |
| 5 | Dry Pond | A | MDR | 2.08 | 0.0 | 61.0 | 0.043 | 0.40 | 0.80 | 0.32 | 0.00 | 0.00 | 0.08 |
| 5 | Dry Pond | A | MULTI-FAMILY | 7.76 | 35.4 | 67.0 | 0.331 | 11.40 | 0.80 | 9.12 | 0.00 | 0.00 | 2.28 |
| 5 | Dry Pond | A | RECREATIONAL | 5.92 | 2.3 | 76.1 | 0.120 | 3.15 | 0.80 | 2.52 | 0.00 | 0.00 | 0.63 |
| 5 | Dry Pond | A | UPLAND HARDWOOD FORESTS | 0.21 | 0.0 | 32.0 | 0.005 | 0.01 | 0.80 | 0.00 | 0.00 | 0.00 | 0.00 |
| 5 | Dry Pond | A | VACANT NONRESIDENTIAL | 0.72 | 0.0 | 39.0 | 0.010 | 0.03 | 0.80 | 0.03 | 0.00 | 0.00 | 0.01 |
| 5 | None | W | WATERWAYS | 281.65 | 0.0 | 98.0 | 0.616 | 770.01 | 0.00 | 0.00 | 0.00 | 0.00 | 770.01 |
| 5 | Pond | A | INSTITUTIONAL | 7.01 | 0.0 | 59.5 | 0.039 | 1.23 | 0.20 | 0.25 | 0.00 | 0.00 | 0.98 |
| 5 | Pond | A | MDR | 5.61 | 0.0 | 69.0 | 0.068 | 1.69 | 0.20 | 0.34 | 0.00 | 0.00 | 1.35 |
| 5 | Pond | A | UPLAND HARDWOOD FORESTS | 0.45 | 0.0 | 32.0 | 0.005 | 0.01 | 0.20 | 0.00 | 0.00 | 0.00 | 0.01 |
| 5 | Pond | W | PONDS | 11.35 | 0.0 | 98.0 | 0.616 | 31.03 | 0.20 | 6.21 | 0.00 | 0.00 | 24.82 |
| 5 | Swale | A | COASTAL SCRUB | 1.64 | 0.0 | 35.0 | 0.007 | 0.05 | 0.20 | 0.01 | 0.00 | 0.00 | 0.04 |
| 5 | Swale | A | COMMERCIAL | 10.46 | 0.0 | 80.0 | 0.130 | 6.03 | 0.20 | 1.21 | 0.00 | 0.00 | 4.83 |
| 5 | Swale | A | INSTITUTIONAL | 1.35 | 0.0 | 43.5 | 0.014 | 0.09 | 0.20 | 0.02 | 0.00 | 0.00 | 0.07 |
| 5 | Swale | A | MDR | 428.88 | 0.0 | 66.4 | 0.059 | 111.96 | 0.20 | 22.39 | 0.00 | 0.00 | 89.57 |
| 5 | Swale | A | MULTI-FAMILY | 0.34 | 0.0 | 89.3 | 0.254 | 0.38 | 0.20 | 0.08 | 0.00 | 0.00 | 0.31 |
| 5 | Swale | A | RECREATIONAL | 9.26 | 11.9 | 47.1 | 0.114 | 4.69 | 0.20 | 0.94 | 0.00 | 0.00 | 3.75 |
| 5 | Swale | A | UPLAND HARDWOOD FORESTS | 18.79 | 0.0 | 32.0 | 0.005 | 0.45 | 0.20 | 0.09 | 0.00 | 0.00 | 0.36 |
| 5 | Swale | A | UTILITIES | 6.67 | 0.0 | 77.4 | 0.112 | 3.32 | 0.20 | 0.66 | 0.00 | 0.00 | 2.65 |
| 5 | Swale | A | VACANT NONRESIDENTIAL | 0.89 | 0.0 | 39.0 | 0.010 | 0.04 | 0.20 | 0.01 | 0.00 | 0.00 | 0.03 |
| 5 | Swale | A/D | MDR | 0.11 | 0.0 | 69.1 | 0.068 | 0.03 | 0.20 | 0.01 | 0.00 | 0.00 | 0.03 |
| 5 | Swale | A/D | UPLAND HARDWOOD FORESTS | 0.11 | 0.0 | 79.0 | 0.123 | 0.06 | 0.20 | 0.01 | 0.00 | 0.00 | 0.05 |
| 5 | Swale-Pond | A | COMMERCIAL | 2.48 | 0.0 | 72.4 | 0.083 | 0.91 | 0.36 | 0.33 | 0.00 | 0.00 | 0.59 |
| 5 | Swale-Pond | A | INSTITUTIONAL | 7.07 | 0.0 | 50.0 | 0.022 | 0.69 | 0.36 | 0.25 | 0.00 | 0.00 | 0.44 |
| 5 | Swale-Pond | A | MDR | 85.40 | 0.0 | 65.8 | 0.057 | 21.49 | 0.36 | 7.74 | 0.00 | 0.00 | 13.75 |
| 5 | Swale-Pond | A | MULTI-FAMILY | 0.30 | 14.1 | 40.8 | 0.126 | 0.17 | 0.36 | 0.06 | 0.00 | 0.00 | 0.11 |
| 5 | Swale-Pond | A | RECREATIONAL | 1.81 | 0.0 | 47.2 | 0.018 | 0.15 | 0.36 | 0.05 | 0.00 | 0.00 | 0.09 |
| 5 | Wetland | A | MDR | 0.31 | 0.0 | 69.1 | 0.068 | 0.09 | 0.10 | 0.01 | 0.00 | 0.00 | 0.08 |
| 5 | Wetland | A | UPLAND HARDWOOD FORESTS | 0.37 | 0.0 | 32.0 | 0.005 | 0.01 | 0.10 | 0.00 | 0.00 | 0.00 | 0.01 |
| 5 | Wetland | A/D | MDR | 0.09 | 0.0 | 69.1 | 0.068 | 0.03 | 0.10 | 0.00 | 0.00 | 0.00 | 0.02 |
| 5 | Wetland | A/D | UPLAND HARDWOOD FORESTS | 0.47 | 0.0 | 79.0 | 0.123 | 0.26 | 0.10 | 0.03 | 0.00 | 0.00 | 0.23 |
| 5 | Rear Swale | A | MDR | 183.54 | 0.0 | 64.1 | 0.051 | 41.92 | 0.95 | 39.82 | 0.00 | 0.00 | 2.10 |

ERD Methodology Runoff Model (Harper and Baker, 2007)

Project Name:

Marco Island

User Inputs

Basin Name:

1, 2, 3, 4, 5, 6, 7

Calc. Values

Meteorological Zone:

4

Annual Rainfall (inches):

53.3

| Sub Basin | Treatment 1 | Hydrologic Soil Group | Land Use | Area (ac.) | DCIA1 (%) | Non - DCIA CN Value2 | Runoff C Value4 | Generated Runoff Volume (ac-ft) | Runoff Volume Reduction Factor | Stormwater Reduction Volume (ac-ft) | Wetland Reduction Factor | Wetland Reduction Volume (ac-ft) | Delivered Runoff Volume (ac-ft) |
|-----------|-------------|-----------------------|--------------------------|------------|-----------|----------------------|-----------------|---------------------------------|--------------------------------|-------------------------------------|--------------------------|----------------------------------|---------------------------------|
| 6 | Direct | A | COASTAL SCRUB | 57.46 | 0.0 | 35.0 | 0.007 | 1.80 | 0.00 | 0.00 | 0.00 | 0.00 | 1.80 |
| 6 | Direct | A | MDR | 4.38 | 0.0 | 65.7 | 0.056 | 1.10 | 0.00 | 0.00 | 0.00 | 0.00 | 1.10 |
| 6 | Direct | A | MULTIFAMILY | 7.78 | 0.0 | 59.2 | 0.039 | 1.34 | 0.00 | 0.00 | 0.00 | 0.00 | 1.34 |
| 6 | Direct | A | RECREATIONAL | 0.82 | 0.1 | 61.3 | 0.045 | 0.16 | 0.00 | 0.00 | 0.00 | 0.00 | 0.16 |
| 6 | Direct | A | SWIMMING BEACH | 281.49 | 0.0 | 77.0 | 0.109 | 136.63 | 0.00 | 0.00 | 0.00 | 0.00 | 136.63 |
| 6 | Direct | A | UPLAND HARDWOOD FORESTS | 0.84 | 0.0 | 32.0 | 0.005 | 0.02 | 0.00 | 0.00 | 0.00 | 0.00 | 0.02 |
| 6 | Direct | A/D | COASTAL SCRUB | 56.76 | 0.0 | 77.0 | 0.109 | 27.55 | 0.00 | 0.00 | 0.00 | 0.00 | 27.55 |
| 6 | Direct | A/D | MDR | 3.80 | 0.0 | 68.5 | 0.066 | 1.12 | 0.00 | 0.00 | 0.00 | 0.00 | 1.12 |
| 6 | Direct | A/D | MULTIFAMILY | 1.32 | 0.0 | 65.8 | 0.057 | 0.33 | 0.00 | 0.00 | 0.00 | 0.00 | 0.33 |
| 6 | Direct | A/D | RECREATIONAL | 0.73 | 0.0 | 82.9 | 0.160 | 0.52 | 0.00 | 0.00 | 0.00 | 0.00 | 0.52 |
| 6 | Direct | A/D | UPLAND HARDWOOD FORESTS | 0.82 | 0.0 | 79.0 | 0.123 | 0.45 | 0.00 | 0.00 | 0.00 | 0.00 | 0.45 |
| 6 | Direct | D | MANGROVE SWAMPS | 22.20 | 0.0 | 87.0 | 0.215 | 21.25 | 0.00 | 0.00 | 0.00 | 0.00 | 21.25 |
| 6 | Direct | W | ENCLOSED SALTWATER PONDS | 17.79 | 0.0 | 98.0 | 0.616 | 48.64 | 0.00 | 0.00 | 0.00 | 0.00 | 48.64 |
| 6 | Direct | W | TIDAL FLATS | 41.66 | 0.0 | 94.0 | 0.397 | 73.39 | 0.00 | 0.00 | 0.00 | 0.00 | 73.39 |

ERD Methodology Runoff Model (Harper and Baker, 2007)

Project Name:

Marco Island

User Inputs

Basin Name:

1, 2, 3, 4, 5, 6, 7

Calc. Values

Meteorological Zone:

4

Annual Rainfall (inches):

53.3

| Sub Basin | Treatment 1 | Hydrologic Soil Group | Land Use | Area (ac.) | DCIA1 (%) | Non - DCIA CN Value2 | Runoff C Value4 | Generated Runoff Volume (ac-ft) | Runoff Volume Reduction Factor | Stormwater Reduction Volume (ac-ft) | Wetland Reduction Factor | Wetland Reduction Volume (ac-ft) | Delivered Runoff Volume (ac-ft) |
|-----------|-------------|-----------------------|-------------------------|------------|-----------|----------------------|-----------------|---------------------------------|--------------------------------|-------------------------------------|--------------------------|----------------------------------|---------------------------------|
| 7 | Direct | A | COASTAL SCRUB | 4.54 | 0.0 | 35.0 | 0.007 | 0.14 | 0.00 | 0.00 | 0.00 | 0.00 | 0.14 |
| 7 | Direct | A | MDR | 32.68 | 0.0 | 64.4 | 0.052 | 7.58 | 0.00 | 0.00 | 0.00 | 0.00 | 7.58 |
| 7 | Direct | A | MULTIFAMILY | 6.75 | 0.0 | 71.9 | 0.081 | 2.42 | 0.00 | 0.00 | 0.00 | 0.00 | 2.42 |
| 7 | Direct | A | RECREATIONAL | 0.47 | 0.0 | 61.2 | 0.044 | 0.09 | 0.00 | 0.00 | 0.00 | 0.00 | 0.09 |
| 7 | Direct | A | SHRUB AND BRUSHLAND | 0.83 | 0.0 | 38.0 | 0.009 | 0.03 | 0.00 | 0.00 | 0.00 | 0.00 | 0.03 |
| 7 | Direct | A | UPLAND HARDWOOD FORESTS | 4.45 | 0.0 | 32.0 | 0.005 | 0.11 | 0.00 | 0.00 | 0.00 | 0.00 | 0.11 |
| 7 | Direct | A/D | COASTAL SCRUB | 0.04 | 0.0 | 77.0 | 0.109 | 0.02 | 0.00 | 0.00 | 0.00 | 0.00 | 0.02 |
| 7 | Direct | A/D | MDR | 8.22 | 0.0 | 62.7 | 0.048 | 1.74 | 0.00 | 0.00 | 0.00 | 0.00 | 1.74 |
| 7 | Direct | A/D | MULTIFAMILY | 3.71 | 0.0 | 57.8 | 0.036 | 0.59 | 0.00 | 0.00 | 0.00 | 0.00 | 0.59 |
| 7 | Direct | A/D | SHRUB AND BRUSHLAND | 6.10 | 0.0 | 77.0 | 0.109 | 2.96 | 0.00 | 0.00 | 0.00 | 0.00 | 2.96 |
| 7 | Direct | A/D | UPLAND HARDWOOD FORESTS | 2.60 | 0.0 | 79.0 | 0.123 | 1.42 | 0.00 | 0.00 | 0.00 | 0.00 | 1.42 |
| 7 | Direct | D | MANGROVE SWAMPS | 169.06 | 0.0 | 87.0 | 0.215 | 161.79 | 0.00 | 0.00 | 0.00 | 0.00 | 161.79 |
| 7 | Direct | W | SALTWATER MARSHES | 14.37 | 0.0 | 98.0 | 0.616 | 39.29 | 0.00 | 0.00 | 0.00 | 0.00 | 39.29 |
| 7 | Dry Pond | A | DRY PONDS | 0.28 | 0.0 | 39.0 | 0.010 | 0.01 | 0.80 | 0.01 | 0.00 | 0.00 | 0.00 |
| 7 | Dry Pond | A | INSTITUTIONAL | 2.23 | 0.0 | 76.6 | 0.107 | 1.06 | 0.80 | 0.84 | 0.00 | 0.00 | 0.21 |
| 7 | Dry Pond | A | MDR | 2.58 | 0.0 | 60.9 | 0.043 | 0.49 | 0.80 | 0.39 | 0.00 | 0.00 | 0.10 |
| 7 | Dry Pond | A | MULTIFAMILY | 2.12 | 0.0 | 85.0 | 0.182 | 1.71 | 0.80 | 1.37 | 0.00 | 0.00 | 0.34 |
| 7 | Dry Pond | A | RECREATIONAL | 2.37 | 0.0 | 57.7 | 0.036 | 0.38 | 0.80 | 0.30 | 0.00 | 0.00 | 0.08 |
| 7 | Dry Pond | A | UPLAND HARDWOOD FORESTS | 0.56 | 0.0 | 32.0 | 0.005 | 0.01 | 0.80 | 0.01 | 0.00 | 0.00 | 0.00 |
| 7 | Dry Pond | A/D | DRY PONDS | 0.04 | 0.0 | 39.0 | 0.010 | 0.00 | 0.80 | 0.00 | 0.00 | 0.00 | 0.00 |
| 7 | Dry Pond | A/D | MDR | 0.84 | 0.0 | 56.4 | 0.033 | 0.12 | 0.80 | 0.10 | 0.00 | 0.00 | 0.02 |
| 7 | Dry Pond | A/D | MULTIFAMILY | 0.47 | 0.0 | 76.2 | 0.104 | 0.22 | 0.80 | 0.17 | 0.00 | 0.00 | 0.04 |
| 7 | Dry Pond | A/D | SHRUB AND BRUSHLAND | 0.35 | 0.0 | 77.0 | 0.109 | 0.17 | 0.80 | 0.14 | 0.00 | 0.00 | 0.03 |
| 7 | Dry Pond | A/D | UPLAND HARDWOOD FORESTS | 0.29 | 0.0 | 79.0 | 0.123 | 0.16 | 0.80 | 0.13 | 0.00 | 0.00 | 0.03 |
| 7 | Swale | A | COMMERCIAL | 0.41 | 0.0 | 70.2 | 0.072 | 0.13 | 0.20 | 0.03 | 0.00 | 0.00 | 0.11 |
| 7 | Swale | A | MDR | 57.45 | 0.4 | 70.8 | 0.078 | 19.99 | 0.20 | 4.00 | 0.00 | 0.00 | 15.99 |
| 7 | Swale | A | MULTIFAMILY | 5.27 | 0.0 | 74.0 | 0.091 | 2.12 | 0.20 | 0.42 | 0.00 | 0.00 | 1.70 |
| 7 | Swale | A | UPLAND HARDWOOD FORESTS | 9.09 | 0.0 | 32.0 | 0.005 | 0.22 | 0.20 | 0.04 | 0.00 | 0.00 | 0.17 |
| 7 | Swale | A/D | MDR | 1.75 | 0.0 | 71.7 | 0.080 | 0.62 | 0.20 | 0.12 | 0.00 | 0.00 | 0.50 |
| 7 | Swale | A/D | SHRUB AND BRUSHLAND | 0.65 | 0.0 | 77.0 | 0.109 | 0.32 | 0.20 | 0.06 | 0.00 | 0.00 | 0.25 |
| 7 | Wet Pond | A/D | SHRUB AND BRUSHLAND | 0.49 | 0.0 | 77.0 | 0.109 | 0.24 | 0.20 | 0.05 | 0.00 | 0.00 | 0.19 |
| 7 | Wet Pond | W | WET PONDS | 0.36 | 0.0 | 98.0 | 0.616 | 0.98 | 0.20 | 0.20 | 0.00 | 0.00 | 0.79 |
| 7 | Wetland | A | INSTITUTIONAL | 0.60 | 0.0 | 56.1 | 0.032 | 0.09 | 0.10 | 0.01 | 0.00 | 0.00 | 0.08 |
| 7 | Wetland | A | MDR | 2.10 | 0.0 | 67.4 | 0.082 | 0.58 | 0.10 | 0.06 | 0.00 | 0.00 | 0.52 |
| 7 | Wetland | A | UPLAND HARDWOOD FORESTS | 1.59 | 0.0 | 32.0 | 0.005 | 0.04 | 0.10 | 0.00 | 0.00 | 0.00 | 0.03 |
| 7 | Wetland | A/D | MDR | 0.62 | 0.0 | 60.4 | 0.042 | 0.11 | 0.10 | 0.01 | 0.00 | 0.00 | 0.10 |
| 7 | Wetland | A/D | SHRUB AND BRUSHLAND | 3.74 | 0.0 | 77.0 | 0.109 | 1.82 | 0.10 | 0.18 | 0.00 | 0.00 | 1.63 |
| 7 | Wetland | A/D | UPLAND HARDWOOD FORESTS | 0.03 | 0.0 | 79.0 | 0.123 | 0.02 | 0.10 | 0.00 | 0.00 | 0.00 | 0.01 |

APPENDIX E

CHARACTERISTICS OF SHALLOW GROUNDWATER SEEPAGE COLLECTED IN MARCO ISLAND FROM APRIL-NOVEMBER 2020

E-1: Field Measurements of Seepage Inflow Volumes

E-2: Chemical Characteristics of Collected Seepage Samples

E-1: Field Measurements of Seepage Inflow Volumes

Seepage Meter Field Measurements

Location: Marco Island

Site: 1

Date Installed: 5/5/20

Chamber Diameter: 0.58 m

Sediment Area Covered: 0.27 m²

| Date | Time Collected | Volume Collected (liters) | Previous Collection Event | | Seepage Time (days) | Seepage (liters/m ² -day) | Comments / Observations |
|--------------|----------------|---------------------------|---------------------------|-------|---------------------|--------------------------------------|---|
| | | | Date | Time | | | |
| 5/5/20 | 8:37 | ----- | ----- | ----- | ----- | ----- | Bags Installed |
| 5/26/20 | 17:14 | 8.75 | 5/5/20 | 8:37 | 21.4 | 1.5 | Sample collected, bag in good condition |
| 6/29/20 | 17:11 | ----- | 5/26/20 | 17:14 | ----- | ----- | No sample collected, meter flipped, reinstalled |
| 7/27/20 | 9:44 | 55 | 6/29/20 | 17:11 | 27.7 | 7.4 | Sample collected, bag in good condition |
| 8/31/20 | 11:55 | 37 | 7/27/20 | 9:44 | 35.1 | 3.9 | Sample collected, bag in good condition |
| 9/23/20 | 11:34 | 110 | 8/31/20 | 11:55 | 23.0 | 17.7 | Sample collected, bag in good condition |
| 11/30/20 | 11:48 | 8.75 | 9/23/20 | 11:34 | 68.0 | 0.5 | Sample collected, meter removed |
| Mean: | | | | | | 4.64 | |

Seepage Meter Field Measurements

Location: Marco Island

Site: 2

Date Installed: 4/29/20

Chamber Diameter: 0.58 m

Sediment Area Covered: 0.27 m²

| Date | Time Collected | Volume Collected (liters) | Previous Collection Event | | Seepage Time (days) | Seepage (liters/m ² -day) | Comments / Observations |
|--------------|----------------|---------------------------|---------------------------|-------|---------------------|--------------------------------------|---|
| | | | Date | Time | | | |
| 4/29/20 | 19:43 | ----- | ----- | ----- | ----- | ----- | Bags Installed |
| 5/26/20 | 16:42 | 5.8 | 4/29/20 | 19:43 | 26.9 | 0.8 | Sample collected, bag in good condition |
| 6/29/20 | 16:32 | 8.8 | 5/26/20 | 16:42 | 34.0 | 1.0 | Sample collected, bag in good condition |
| 7/27/20 | 8:05 | 15.5 | 6/29/20 | 16:32 | 27.6 | 2.1 | Sample collected, bag in good condition |
| 8/31/20 | 12:21 | 6.5 | 7/27/20 | 8:05 | 35.2 | 0.7 | Sample collected, bag in good condition |
| 9/23/20 | 13:26 | 28.8 | 8/31/20 | 12:21 | 23.0 | 4.6 | Sample collected, bag in good condition |
| 11/30/20 | 12:08 | 74.0 | 9/23/20 | 13:26 | 67.9 | 4.0 | Sample collected, meter removed |
| Mean: | | | | | | 2.40 | |

Seepage Meter Field Measurements

Location: Marco Island

Site: 3

Date Installed: 4/29/20

Chamber Diameter: 0.58 m

Sediment Area Covered: 0.27 m²

| Date | Time Collected | Volume Collected (liters) | Previous Collection Event | | Seepage Time (days) | Seepage (liters/m ² -day) | Comments / Observations |
|--------------|----------------|---------------------------|---------------------------|-------|---------------------|--------------------------------------|---|
| | | | Date | Time | | | |
| 4/29/20 | 17:55 | ----- | ----- | ----- | ----- | ----- | Bags Installed |
| 5/26/20 | 15:30 | 7.8 | 4/29/20 | 17:55 | 26.9 | 1.1 | Sample collected, bag in good condition |
| 6/29/20 | 15:16 | 23.3 | 5/26/20 | 15:30 | 34.0 | 2.5 | Sample collected, bag in good condition |
| 7/27/20 | 8:29 | 15.8 | 6/29/20 | 15:16 | 27.7 | 2.1 | Sample collected, bag in good condition |
| 8/31/20 | 12:48 | 8.8 | 7/27/20 | 8:29 | 35.2 | 0.9 | Sample collected, bag in good condition |
| 9/23/20 | 11:50 | 16.5 | 8/31/20 | 12:48 | 23.0 | 2.7 | Sample collected, bag in good condition |
| 11/30/20 | 11:27 | 12.5 | 9/23/20 | 11:50 | 68.0 | 0.7 | Sample collected, meter removed |
| Mean: | | | | | | 1.46 | |

Seepage Meter Field Measurements

Location: Marco Island

Site: 4

Date Installed: 5/5/20

Chamber Diameter: 0.58 m

Sediment Area Covered: 0.27 m²

| Date | Time Collected | Volume Collected (liters) | Previous Collection Event | | Seepage Time (days) | Seepage (liters/m ² -day) | Comments / Observations |
|----------|----------------|---------------------------|---------------------------|-------|---------------------|--------------------------------------|--|
| | | | Date | Time | | | |
| 5/5/20 | 10:57 | ----- | ----- | ----- | ----- | ----- | Bags Installed |
| 5/26/20 | 18:36 | ----- | 5/5/20 | 10:57 | ----- | ----- | No sample collected, bag damaged, bag replaced |
| 6/29/20 | 18:03 | 110 | 5/26/20 | 18:36 | 34.0 | 12.0 | Sample collected, bag in good condition |
| 7/27/20 | 10:19 | 110 | 6/29/20 | 18:03 | 27.7 | 14.7 | Sample collected, bag in good condition |
| 8/31/20 | 15:10 | 21.5 | 7/27/20 | 10:19 | 35.2 | 2.3 | Sample collected, bag in good condition |
| 9/23/20 | 14:23 | 73.0 | 8/31/20 | 15:10 | 23.0 | 11.8 | Sample collected, bag in good condition |
| 11/30/20 | 13:37 | 98.0 | 9/23/20 | 14:23 | 68.0 | 5.3 | Sample collected, meter removed |
| | | | | | Mean: | 8.14 | |

Seepage Meter Field Measurements

Location: Marco Island

Site: 5

Date Installed: 5/5/20

Chamber Diameter: 0.58 m

Sediment Area Covered: 0.27 m²

| Date | Time Collected | Volume Collected (liters) | Previous Collection Event | | Seepage Time (days) | Seepage (liters/m ² -day) | Comments / Observations |
|----------|----------------|---------------------------|---------------------------|-------|---------------------|--------------------------------------|---|
| | | | Date | Time | | | |
| 5/5/20 | 11:45 | ----- | ----- | ----- | ----- | ----- | Bags Installed |
| 5/26/20 | 18:55 | 80.5 | 5/5/20 | 11:45 | 21.3 | 14.0 | Sample collected, bag in good condition |
| 6/29/20 | 18:29 | 55.0 | 5/26/20 | 18:55 | 34.0 | 6.0 | Sample collected, bag in good condition |
| 7/27/20 | 10:49 | ----- | 6/29/20 | 18:29 | ----- | ----- | No sample collected, meter flipped, meter reinstalled |
| 8/31/20 | 15:47 | 6.8 | 7/27/20 | 10:49 | 35.2 | 0.7 | Sample collected, bag in good condition |
| 9/23/20 | 14:50 | 55.0 | 8/31/20 | 15:47 | 23.0 | 8.9 | Sample collected, bag in good condition |
| 11/30/20 | 14:00 | 5.8 | 9/23/20 | 14:50 | 68.0 | 0.3 | Sample collected, meter removed |
| | | | | | Mean: | 4.14 | |

Seepage Meter Field Measurements

Location: Marco Island

Site: 6

Date Installed: 5/5/20

Chamber Diameter: 0.58 m

Sediment Area Covered: 0.27 m²

| Date | Time Collected | Volume Collected (liters) | Previous Collection Event | | Seepage Time (days) | Seepage (liters/m ² -day) | Comments / Observations |
|----------|----------------|---------------------------|---------------------------|-------|---------------------|--------------------------------------|---|
| | | | Date | Time | | | |
| 5/5/20 | 12:48 | ----- | ----- | ----- | ----- | ----- | Bags Installed |
| 5/27/20 | 9:34 | 95.0 | 5/5/20 | 12:48 | 21.9 | 16.1 | Sample collected, bag in good condition |
| 6/29/20 | 19:27 | 110 | 5/27/20 | 9:34 | 33.4 | 12.2 | Sample collected, bag in good condition |
| 7/27/20 | 11:33 | 110 | 6/29/20 | 19:27 | 27.7 | 14.7 | Sample collected, bag in good condition |
| 8/31/20 | 16:41 | 73.0 | 7/27/20 | 11:33 | 35.2 | 7.7 | Sample collected, bag in good condition |
| 9/23/20 | 15:40 | 110 | 8/31/20 | 16:41 | 23.0 | 17.7 | Sample collected, bag in good condition |
| 11/30/20 | 14:40 | ----- | 9/23/20 | 15:40 | ----- | ----- | No sample collected, meter flipped, meter removed |
| | | | | | Mean: | 13.07 | |

Seepage Meter Field Measurements

Location: Marco Island

Site: 7

Date Installed: 4/29/20

Chamber Diameter: 0.58 m

Sediment Area Covered: 0.27 m²

| Date | Time Collected | Volume Collected (liters) | Previous Collection Event | | Seepage Time (days) | Seepage (liters/m ² -day) | Comments / Observations |
|--------------|----------------|---------------------------|---------------------------|-------|---------------------|--------------------------------------|---|
| | | | Date | Time | | | |
| 4/29/20 | 19:06 | ----- | ----- | ----- | ----- | ----- | Bags Installed |
| 5/27/20 | 8:30 | 90 | 4/29/20 | 19:06 | 27.6 | 12.1 | Sample collected, bag in good condition |
| 6/29/20 | 15:42 | 110 | 5/27/20 | 8:30 | 33.3 | 12.2 | Sample collected, bag in good condition |
| 7/27/20 | 9:09 | 110 | 6/29/20 | 15:42 | 27.7 | 14.7 | Sample collected, bag in good condition |
| 8/31/20 | 14:02 | 110 | 7/27/20 | 9:09 | 35.2 | 11.6 | Sample collected, bag in good condition |
| 9/23/20 | 12:40 | ----- | 8/31/20 | 14:02 | ----- | ----- | No sample collected, can't find meter, replaced meter |
| 11/30/20 | 12:27 | ----- | 9/23/20 | 12:40 | ----- | ----- | No sample collected, can't find meter |
| Mean: | | | | | | 12.57 | |

Seepage Meter Field Measurements

Location: Marco Island

Site: 8

Date Installed: 4/29/20

Chamber Diameter: 0.58 m

Sediment Area Covered: 0.27 m²

| Date | Time Collected | Volume Collected (liters) | Previous Collection Event | | Seepage Time (days) | Seepage (liters/m ² -day) | Comments / Observations |
|--------------|----------------|---------------------------|---------------------------|-------|---------------------|--------------------------------------|---|
| | | | Date | Time | | | |
| 4/29/20 | 18:35 | ----- | ----- | ----- | ----- | ----- | Bags Installed |
| 5/27/20 | 8:02 | 90 | 4/29/20 | 18:35 | 27.6 | 12.1 | Sample collected, bag in good condition |
| 6/29/20 | 16:18 | 110 | 5/27/20 | 8:02 | 33.3 | 12.2 | Sample collected, bag in good condition |
| 7/27/20 | 8:47 | 110 | 6/29/20 | 16:18 | 27.7 | 14.7 | Sample collected, bag in good condition |
| 8/31/20 | 13:23 | 55 | 7/27/20 | 8:47 | 35.2 | 5.8 | Sample collected, bag in good condition |
| 9/23/20 | 12:12 | 110 | 8/31/20 | 13:23 | 23.0 | 17.8 | Sample collected, bag in good condition |
| 11/30/20 | 12:48 | 74 | 9/23/20 | 12:12 | 68.0 | 4.0 | Sample collected, meter removed |
| Mean: | | | | | | 9.47 | |

Seepage Meter Field Measurements

Location: Marco Island

Site: 9

Date Installed: 5/5/20

Chamber Diameter: 0.58 m

Sediment Area Covered: 0.27 m²

| Date | Time Collected | Volume Collected (liters) | Previous Collection Event | | Seepage Time (days) | Seepage (liters/m ² -day) | Comments / Observations |
|--------------|----------------|---------------------------|---------------------------|-------|---------------------|--------------------------------------|---|
| | | | Date | Time | | | |
| 5/5/20 | 12:11 | ----- | ----- | ----- | ----- | ----- | Bags Installed |
| 5/26/20 | 19:19 | 90.0 | 5/5/20 | 12:11 | 21.3 | 15.7 | Sample collected, bag in good condition |
| 6/29/20 | 19:09 | 55.0 | 5/26/20 | 19:19 | 34.0 | 6.0 | Sample collected, bag in good condition |
| 7/27/20 | 11:08 | 5.8 | 6/29/20 | 19:09 | 27.7 | 0.8 | Sample collected, bag in good condition |
| 8/31/20 | 16:19 | 25.8 | 7/27/20 | 11:08 | 35.2 | 2.7 | Sample collected, bag in good condition |
| 9/23/20 | 15:14 | 55.0 | 8/31/20 | 16:19 | 23.0 | 8.9 | Sample collected, bag in good condition |
| 11/30/20 | 14:03 | ----- | 9/23/20 | 15:14 | ----- | ----- | No sample collected, bag damaged, meter removed |
| Mean: | | | | | | 6.08 | |

Seepage Meter Field Measurements

Location: Marco Island

Site: 10

Date Installed: 5/5/20

Chamber Diameter: 0.58 m

Sediment Area Covered: 0.27 m²

| Date | Time Collected | Volume Collected (liters) | Previous Collection Event | | Seepage Time (days) | Seepage (liters/m ² -day) | Comments / Observations |
|----------|----------------|---------------------------|---------------------------|-------|---------------------|--------------------------------------|--|
| | | | Date | Time | | | |
| 5/5/20 | 13:32 | ----- | ----- | ----- | ----- | ----- | Bags Installed |
| 5/27/20 | 9:57 | ----- | 5/5/20 | 13:32 | ----- | ----- | Sample collected, bag in good condition |
| 6/29/20 | 19:56 | 73 | 5/27/20 | 9:57 | 33.4 | 8.1 | No sample collected, bag damaged, bag replaced |
| 7/27/20 | 12:07 | 110 | 6/29/20 | 19:56 | 27.7 | 14.7 | Sample collected, bag in good condition |
| 8/31/20 | 17:10 | 6.5 | 7/27/20 | 12:07 | 35.2 | 0.7 | Sample collected, bag in good condition |
| 9/23/20 | 16:05 | 30.5 | 8/31/20 | 17:10 | 23.0 | 4.9 | Sample collected, bag in good condition |
| 11/30/20 | 15:00 | 14.25 | 9/23/20 | 16:05 | 68.0 | 0.8 | Sample collected, meter removed |
| | | | | | Mean: | 4.63 | |

Seepage Meter Field Measurements

Location: Marco Island

Site: 11

Date Installed: 4/29/20

Chamber Diameter: 0.58 m

Sediment Area Covered: 0.27 m²

| Date | Time Collected | Volume Collected (liters) | Previous Collection Event | | Seepage Time (days) | Seepage (liters/m ² -day) | Comments / Observations |
|----------|----------------|---------------------------|---------------------------|-------|---------------------|--------------------------------------|---|
| | | | Date | Time | | | |
| 4/29/20 | 15:41 | ----- | ----- | ----- | ----- | ----- | Bags Installed |
| 5/26/20 | 11:18 | 95.0 | 4/29/20 | 15:41 | 26.8 | 13.1 | Sample collected, bag in good condition |
| 6/29/20 | 10:44 | 110 | 5/26/20 | 11:18 | 34.0 | 12.0 | Sample collected, bag in good condition |
| 7/27/20 | 13:50 | 110 | 6/29/20 | 10:44 | 28.1 | 14.5 | Sample collected, bag in good condition |
| 8/31/20 | 9:20 | 9.3 | 7/27/20 | 13:50 | 34.8 | 1.0 | Sample collected, bag in good condition |
| 9/23/20 | 9:22 | 73.0 | 8/31/20 | 9:20 | 23.0 | 11.8 | Sample collected, bag in good condition |
| 11/30/20 | 10:20 | 12.8 | 9/23/20 | 9:22 | 68.0 | 0.7 | Sample collected, meter removed |
| | | | | | Mean: | 7.07 | |

Seepage Meter Field Measurements

Location: Marco Island

Site: 12

Date Installed: 4/29/20

Chamber Diameter: 0.58 m

Sediment Area Covered: 0.27 m²

| Date | Time Collected | Volume Collected (liters) | Previous Collection Event | | Seepage Time (days) | Seepage (liters/m ² -day) | Comments / Observations |
|----------|----------------|---------------------------|---------------------------|-------|---------------------|--------------------------------------|---|
| | | | Date | Time | | | |
| 4/29/20 | 13:00 | ----- | ----- | ----- | ----- | ----- | Bags Installed |
| 5/26/20 | 13:15 | 83.0 | 4/29/20 | 13:00 | 27.0 | 11.4 | Sample collected, bag in good condition |
| 6/29/20 | 11:53 | 110 | 5/26/20 | 13:15 | 33.9 | 12.0 | Sample collected, bag in good condition |
| 7/27/20 | 14:56 | 110 | 6/29/20 | 11:53 | 28.1 | 14.5 | Sample collected, bag in good condition |
| 8/31/20 | 10:10 | 39.8 | 7/27/20 | 14:56 | 34.8 | 4.2 | Sample collected, bag in good condition |
| 9/23/20 | 9:57 | 73.0 | 8/31/20 | 10:10 | 23.0 | 11.8 | Sample collected, bag in good condition |
| 11/30/20 | 9:46 | 98.0 | 9/23/20 | 9:57 | 68.0 | 5.3 | Sample collected, meter removed |
| | | | | | Mean: | 8.86 | |

Seepage Meter Field Measurements

Location: Marco Island

Site: 13

Date Installed: 5/5/20

Chamber Diameter: 0.58 m

Sediment Area Covered: 0.27 m²

| Date | Time Collected | Volume Collected (liters) | Previous Collection Event | | Seepage Time (days) | Seepage (liters/m ² -day) | Comments / Observations |
|----------|----------------|---------------------------|---------------------------|-------|---------------------|--------------------------------------|--|
| | | | Date | Time | | | |
| 5/5/20 | 11:55 | ----- | ----- | ----- | ----- | ----- | Bags Installed |
| 5/26/20 | 19:05 | 95.0 | 5/5/20 | 11:55 | 21.3 | 16.5 | Sample collected, bag in good condition |
| 6/29/20 | 18:41 | 110 | 5/26/20 | 19:05 | 34.0 | 12.0 | Sample collected, bag in good condition |
| 7/27/20 | 10:55 | ----- | 6/29/20 | 18:41 | ----- | ----- | No sample collected, bag damaged, bag replaced |
| 8/31/20 | 16:05 | 15.3 | 7/27/20 | 10:55 | 35.2 | 1.6 | Sample collected, bag in good condition |
| 9/23/20 | 14:59 | 110 | 8/31/20 | 16:05 | 23.0 | 17.7 | Sample collected, bag in good condition |
| 11/30/20 | 14:08 | 148 | 9/23/20 | 14:59 | 68.0 | 8.1 | Sample collected, meter removed |
| | | | | | Mean: | 9.76 | |

Seepage Meter Field Measurements

Location: Marco Island

Site: 14

Date Installed: 4/29/20

Chamber Diameter: 0.58 m

Sediment Area Covered: 0.27 m²

| Date | Time Collected | Volume Collected (liters) | Previous Collection Event | | Seepage Time (days) | Seepage (liters/m ² -day) | Comments / Observations |
|----------|----------------|---------------------------|---------------------------|-------|---------------------|--------------------------------------|---|
| | | | Date | Time | | | |
| 4/29/20 | 11:33 | ----- | ----- | ----- | ----- | ----- | Bags Installed |
| 5/26/20 | 12:43 | 68.0 | 4/29/20 | 11:33 | 27.0 | 9.3 | Sample collected, bag in good condition |
| 6/29/20 | 11:24 | 37.0 | 5/26/20 | 12:43 | 33.9 | 4.0 | Sample collected, bag in good condition |
| 7/27/20 | 14:21 | 29.8 | 6/29/20 | 11:24 | 28.1 | 3.9 | Sample collected, bag in good condition |
| 8/31/20 | 9:49 | 55.0 | 7/27/20 | 14:21 | 34.8 | 5.9 | Sample collected, bag in good condition |
| 9/23/20 | 9:42 | 33.5 | 8/31/20 | 9:49 | 23.0 | 5.4 | Sample collected, bag in good condition |
| 11/30/20 | 9:30 | 8.3 | 9/23/20 | 9:42 | 68.0 | 0.4 | Sample collected, meter removed |
| | | | | | Mean: | 3.99 | |

Seepage Meter Field Measurements

Location: Marco Island

Site: 15

Date Installed: 4/29/20

Chamber Diameter: 0.58 m

Sediment Area Covered: 0.27 m²

| Date | Time Collected | Volume Collected (liters) | Previous Collection Event | | Seepage Time (days) | Seepage (liters/m ² -day) | Comments / Observations |
|----------|----------------|---------------------------|---------------------------|-------|---------------------|--------------------------------------|---|
| | | | Date | Time | | | |
| 4/29/20 | 13:54 | ----- | ----- | ----- | ----- | ----- | Bags Installed |
| 5/26/20 | 12:07 | 95.0 | 4/29/20 | 13:54 | 26.9 | 13.1 | Sample collected, bag in good condition |
| 6/29/20 | 11:14 | 55.0 | 5/26/20 | 12:07 | 34.0 | 6.0 | Sample collected, bag in good condition |
| 7/27/20 | 15:24 | 7.8 | 6/29/20 | 11:14 | 28.2 | 1.0 | Sample collected, bag in good condition |
| 8/31/20 | 10:04 | 23.3 | 7/27/20 | 15:24 | 34.8 | 2.5 | Sample collected, bag in good condition |
| 9/23/20 | 10:19 | 73.0 | 8/31/20 | 10:04 | 23.0 | 11.7 | Sample collected, bag in good condition |
| 11/30/20 | 9:17 | 74.0 | 9/23/20 | 10:19 | 68.0 | 4.0 | Sample collected, meter removed |
| | | | | | Mean: | 5.66 | |

Seepage Meter Field Measurements

Location: Marco Island

Site: 16

Date Installed: 4/29/20

Chamber Diameter: 0.58 m

Sediment Area Covered: 0.27 m²

| Date | Time Collected | Volume Collected (liters) | Previous Collection Event | | Seepage Time (days) | Seepage (liters/m ² -day) | Comments / Observations |
|--------------|----------------|---------------------------|---------------------------|-------|---------------------|--------------------------------------|---|
| | | | Date | Time | | | |
| 4/29/20 | 14:27 | ----- | ----- | ----- | ----- | ----- | Bags Installed |
| 5/26/20 | 10:32 | ----- | 4/29/20 | 14:27 | ----- | ----- | No sample collected, can't find meter, replaced meter |
| 6/29/20 | 10:04 | ----- | 5/26/20 | 10:32 | ----- | ----- | No sample collected, can't find meter, replaced meter |
| 7/27/20 | 16:12 | ----- | 6/29/20 | 10:04 | ----- | ----- | No sample collected, can't find meter, replaced meter |
| 8/31/20 | 8:42 | ----- | 7/27/20 | 16:12 | ----- | ----- | No sample collected, can't find meter |
| 9/23/20 | 9:01 | ----- | 8/31/20 | 8:42 | ----- | ----- | No sample collected, can't find meter |
| 11/30/20 | 8:48 | ----- | 9/23/20 | 9:01 | ----- | ----- | No sample collected, can't find meter |
| Mean: | | | | | | ----- | |

E-2: Chemical Characteristics of Collected Seepage Samples

Characteristics of Groundwater Seepage Samples Collected at Marco Island from May-November 2020

| Lab ID (20-xxxx) | Site | Date Collected | pH (s.u.) | Alkalinity (mg/L) | Cond (µmho/cm) | Ammonia N (µg/L) | NOx-N (µg/L) | Diss.Org. N (µg/L) | Total N (µg/L) | SRP (µg/L) | Diss.Org. P (µg/L) | Total P (µg/L) |
|------------------------------|------|----------------|-------------|-------------------|----------------|------------------|--------------|--------------------|----------------|------------|--------------------|----------------|
| 2396 | SP-1 | 7/27/20 | 7.56 | 144 | 47,190 | 129 | 603 | 135 | 867 | 75 | 66 | 141 |
| 2812 | SP-1 | 8/31/20 | 7.59 | 151 | 46,652 | 80 | 414 | 342 | 836 | 126 | 64 | 190 |
| 3091 | SP-1 | 9/23/20 | 7.40 | 129 | 43,248 | 133 | 548 | 288 | 969 | 76 | 86 | 162 |
| 3729 | SP-1 | 11/30/20 | 7.24 | 134 | 47400 | 195 | 631 | 806 | 1632 | 116 | 6 | 122 |
| Minimum Value: | | | 7.24 | 129 | 43,248 | 80 | 414 | 135 | 836 | 75 | 6 | 122 |
| Maximum Value: | | | 7.59 | 151 | 47,400 | 195 | 631 | 806 | 1,632 | 126 | 86 | 190 |
| Geometric Mean Value: | | | 7.45 | 139 | 46,091 | 128 | 542 | 322 | 1,035 | 96 | 38 | 152 |
| 2058 | SP-2 | 6/30/20 | 7.81 | 144 | 50,140 | 173 | 142 | 743 | 1,058 | 121 | 40 | 161 |
| 2397 | SP-2 | 7/27/20 | 7.81 | 138 | 45,210 | 151 | 236 | 583 | 970 | 72 | 45 | 117 |
| 2813 | SP-2 | 8/31/20 | 7.72 | 147 | 42,620 | 155 | 211 | 773 | 1,139 | 112 | 38 | 150 |
| 3092 | SP-2 | 9/23/20 | 7.58 | 145 | 37,418 | 489 | 257 | 548 | 1,294 | 116 | 118 | 234 |
| 3730 | SP-2 | 11/30/20 | 7.68 | 140 | 43400 | 104 | 435 | 857 | 1396 | 75 | 43 | 118 |
| Minimum Value: | | | 7.58 | 138 | 37,418 | 104 | 142 | 548 | 970 | 72 | 38 | 117 |
| Maximum Value: | | | 7.81 | 147 | 50,140 | 489 | 435 | 857 | 1,396 | 121 | 118 | 234 |
| Geometric Mean Value: | | | 7.72 | 143 | 43,563 | 183 | 240 | 691 | 1,161 | 97 | 51 | 151 |
| 2059 | SP-3 | 6/30/20 | 7.74 | 138 | 50,794 | 45 | 172 | 584 | 801 | 114 | 36 | 150 |
| 2398 | SP-3 | 7/27/20 | 7.79 | 144 | 46,860 | 95 | 169 | 556 | 820 | 58 | 70 | 128 |
| 2814 | SP-3 | 8/31/20 | 7.54 | 142 | 46,117 | 186 | 124 | 773 | 1,083 | 109 | 37 | 146 |
| 3093 | SP-3 | 9/23/20 | 7.53 | 128 | 40,068 | 283 | 88 | 754 | 1,125 | 73 | 19 | 92 |
| 3731 | SP-3 | 11/30/20 | 7.19 | 139 | 47000 | 287 | 219 | 940 | 1446 | 78 | 100 | 178 |
| Minimum Value: | | | 7.19 | 128 | 40,068 | 45 | 88 | 556 | 801 | 58 | 19 | 92 |
| Maximum Value: | | | 7.79 | 144 | 50,794 | 287 | 219 | 940 | 1,446 | 114 | 100 | 178 |
| Geometric Mean Value: | | | 7.56 | 138 | 46,034 | 145 | 147 | 708 | 1,030 | 84 | 45 | 136 |
| 2060 | SP-4 | 6/30/20 | 7.87 | 158 | 52,211 | 555 | 163 | 446 | 1,164 | 242 | 52 | 294 |
| 2400 | SP-4 | 7/27/20 | 7.80 | 151 | 43,560 | 449 | 341 | 562 | 1,352 | 190 | 30 | 220 |
| 2815 | SP-4 | 8/31/20 | 7.63 | 139 | 47,401 | 376 | 203 | 708 | 1,287 | 245 | 24 | 269 |
| 3094 | SP-4 | 9/23/20 | 7.59 | 142 | 44,838 | 697 | 130 | 398 | 1,225 | 265 | 27 | 292 |
| 3732 | SP-4 | 11/30/20 | 7.63 | 135 | 47300 | 92 | 329 | 923 | 1344 | 133 | 97 | 230 |
| Minimum Value: | | | 7.59 | 135 | 43,560 | 92 | 130 | 398 | 1,164 | 133 | 24 | 220 |
| Maximum Value: | | | 7.87 | 158 | 52,211 | 697 | 341 | 923 | 1,352 | 265 | 97 | 294 |
| Geometric Mean Value: | | | 7.70 | 145 | 46,971 | 360 | 217 | 579 | 1,272 | 209 | 40 | 259 |
| 2062 | SP-5 | 6/30/20 | 7.99 | 146 | 49,922 | 21 | 548 | 483 | 1,052 | 120 | 9 | 129 |
| 2817 | SP-5 | 8/31/20 | 7.72 | 142 | 46,652 | 126 | 88 | 596 | 810 | 72 | 43 | 115 |
| 3095 | SP-5 | 9/23/20 | 7.63 | 128 | 37,736 | 221 | 155 | 513 | 889 | 72 | 10 | 82 |
| 3733 | SP-5 | 11/30/20 | 7.56 | 128 | 47100 | 1137 | 104 | 969 | 2210 | 83 | 4 | 87 |
| Minimum Value: | | | 7.56 | 128 | 37,736 | 21 | 88 | 483 | 810 | 72 | 4 | 82 |
| Maximum Value: | | | 7.99 | 146 | 49,922 | 1,137 | 548 | 969 | 2,210 | 120 | 43 | 129 |
| Geometric Mean Value: | | | 7.72 | 136 | 45,106 | 161 | 167 | 615 | 1,137 | 85 | 11 | 101 |
| 2063 | SP-6 | 6/30/20 | 7.57 | 408 | 40,221 | 3,432 | 110 | 921 | 4,463 | 250 | 43 | 293 |
| 2401 | SP-6 | 7/27/20 | 7.54 | 382 | 45,540 | 2,998 | 90 | 792 | 3,880 | 190 | 44 | 234 |
| 2818 | SP-6 | 8/31/20 | 7.68 | 245 | 44,726 | 1,229 | 101 | 541 | 1,871 | 130 | 49 | 179 |
| 3096 | SP-6 | 9/23/20 | 7.19 | 219 | 37,524 | 1,655 | 124 | 157 | 1,936 | 137 | 33 | 170 |
| Minimum Value: | | | 7.19 | 219 | 37,524 | 1,229 | 90 | 157 | 1,871 | 130 | 33 | 170 |
| Maximum Value: | | | 7.68 | 408 | 45,540 | 3,432 | 124 | 921 | 4,463 | 250 | 49 | 293 |
| Geometric Mean Value: | | | 7.49 | 302 | 41,872 | 2,139 | 106 | 499 | 2,814 | 171 | 42 | 214 |
| 2064 | SP-7 | 6/30/20 | 7.93 | 147 | 49,813 | 19 | 97 | 623 | 739 | 87 | 59 | 146 |
| 2402 | SP-7 | 7/27/20 | 7.73 | 150 | 47,080 | 14 | 541 | 330 | 885 | 37 | 103 | 140 |
| 2820 | SP-7 | 8/31/20 | 7.74 | 149 | 38,630 | 296 | 419 | 979 | 1,694 | 41 | 183 | 224 |
| Minimum Value: | | | 7.73 | 147 | 38,630 | 14 | 97 | 330 | 739 | 37 | 59 | 140 |
| Maximum Value: | | | 7.93 | 150 | 49,813 | 296 | 541 | 979 | 1,694 | 87 | 183 | 224 |
| Geometric Mean Value: | | | 7.80 | 149 | 44,913 | 43 | 280 | 586 | 1,035 | 51 | 104 | 166 |

Characteristics of Groundwater Seepage Samples Collected at Marco Island from May-November 2020

| Lab ID (20-xxxx) | Site | Date Collected | pH (s.u.) | Alkalinity (mg/L) | Cond (µmho/cm) | Ammonia N (µg/L) | NOx-N (µg/L) | Diss.Org. N (µg/L) | Total N (µg/L) | SRP (µg/L) | Diss.Org. P (µg/L) | Total P (µg/L) |
|------------------------------|-------|----------------|-------------|-------------------|----------------|------------------|--------------|--------------------|----------------|------------|--------------------|----------------|
| 2065 | SP-8 | 6/30/20 | 7.84 | 148 | 50,576 | 54 | 1,034 | 490 | 1,578 | 200 | 54 | 254 |
| 2404 | SP-8 | 7/27/20 | 7.64 | 157 | 48,510 | 78 | 747 | 674 | 1,499 | 299 | 37 | 336 |
| 2821 | SP-8 | 8/31/20 | 7.61 | 138 | 44,298 | 561 | 188 | 370 | 1,119 | 166 | 32 | 198 |
| 3097 | SP-8 | 9/23/20 | 7.37 | 220 | 39,220 | 1,582 | 100 | 269 | 1,951 | 341 | 23 | 364 |
| 3734 | SP-8 | 11/30/20 | 7.61 | 142 | 42400 | 610 | 191 | 887 | 1688 | 152 | 38 | 190 |
| Minimum Value: | | | 7.37 | 138 | 39,220 | 54 | 100 | 269 | 1,119 | 152 | 23 | 190 |
| Maximum Value: | | | 7.84 | 220 | 50,576 | 1,582 | 1,034 | 887 | 1,951 | 341 | 54 | 364 |
| Geometric Mean Value: | | | 7.61 | 159 | 44,813 | 296 | 308 | 493 | 1,542 | 220 | 35 | 259 |
| | | | | | | | | | | | | |
| 2066 | SP-9 | 6/30/20 | 8.37 | 146 | 50,794 | 39 | 145 | 503 | 687 | 89 | 20 | 109 |
| 2405 | SP-9 | 7/27/20 | 7.82 | 131 | 47,520 | 46 | 205 | 424 | 675 | 85 | 23 | 108 |
| 2822 | SP-9 | 8/31/20 | 7.59 | 142 | 44,940 | 40 | 481 | 489 | 1,010 | 118 | 17 | 135 |
| 3099 | SP-9 | 9/23/20 | 7.82 | 152 | 43,460 | 78 | 159 | 441 | 678 | 158 | 6 | 164 |
| Minimum Value: | | | 7.59 | 131 | 43,460 | 39 | 145 | 424 | 675 | 85 | 6 | 108 |
| Maximum Value: | | | 8.37 | 152 | 50,794 | 78 | 481 | 503 | 1,010 | 158 | 23 | 164 |
| Geometric Mean Value: | | | 7.89 | 143 | 46,596 | 49 | 218 | 463 | 751 | 109 | 15 | 127 |
| | | | | | | | | | | | | |
| 2068 | SP-10 | 6/30/20 | 7.78 | 188 | 50,685 | 855 | 2,018 | 353 | 3,226 | 448 | 87 | 535 |
| 2406 | SP-10 | 7/27/20 | 7.56 | 175 | 46,090 | 1,091 | 600 | 792 | 2,483 | 280 | 65 | 345 |
| 2823 | SP-10 | 8/31/20 | 7.71 | 151 | 46,438 | 1,102 | 152 | 552 | 1,806 | 311 | 63 | 374 |
| 3100 | SP-10 | 9/23/20 | 7.63 | 167 | 45,898 | 2,323 | 415 | 360 | 3,098 | 383 | 49 | 432 |
| 3736 | SP-10 | 11/30/20 | 7.59 | 147 | 46200 | 562 | 398 | 988 | 1948 | 171 | 70 | 241 |
| Minimum Value: | | | 7.56 | 147 | 45,898 | 562 | 152 | 353 | 1,806 | 171 | 49 | 241 |
| Maximum Value: | | | 7.78 | 188 | 50,685 | 2,323 | 2,018 | 988 | 3,226 | 448 | 87 | 535 |
| Geometric Mean Value: | | | 7.65 | 165 | 47,028 | 1,061 | 497 | 560 | 2,445 | 303 | 66 | 373 |
| | | | | | | | | | | | | |
| 2069 | SP-11 | 6/30/20 | 7.89 | 139 | 52,211 | 21 | 180 | 672 | 873 | 90 | 77 | 167 |
| 2407 | SP-11 | 7/27/20 | 7.62 | 140 | 47,740 | 49 | 76 | 639 | 764 | 43 | 120 | 163 |
| 2824 | SP-11 | 8/31/20 | 7.53 | 158 | 47,508 | 70 | 179 | 702 | 951 | 51 | 85 | 136 |
| 3101 | SP-11 | 9/23/20 | 7.79 | 145 | 40,068 | 335 | 166 | 393 | 894 | 84 | 62 | 146 |
| 3738 | SP-11 | 11/30/20 | 7.84 | 146 | 47800 | 54 | 247 | 768 | 1069 | 42 | 3 | 45 |
| Minimum Value: | | | 7.53 | 139 | 40,068 | 21 | 76 | 393 | 764 | 42 | 3 | 45 |
| Maximum Value: | | | 7.89 | 158 | 52,211 | 335 | 247 | 768 | 1,069 | 90 | 120 | 167 |
| Geometric Mean Value: | | | 7.73 | 145 | 46,895 | 67 | 159 | 619 | 905 | 59 | 43 | 119 |
| | | | | | | | | | | | | |
| 2070 | SP-12 | 6/30/20 | 8.32 | 190 | 47,415 | 30 | 295 | 455 | 780 | 133 | 89 | 222 |
| 2408 | SP-12 | 7/27/20 | 7.74 | 139 | 47,080 | 52 | 42 | 399 | 493 | 56 | 142 | 198 |
| 2825 | SP-12 | 8/31/20 | 7.60 | 143 | 46,973 | 365 | 327 | 189 | 881 | 121 | 157 | 278 |
| 3102 | SP-12 | 9/23/20 | 8.01 | 168 | 33,708 | 288 | 467 | 169 | 924 | 85 | 103 | 188 |
| 3739 | SP-12 | 11/30/20 | 7.72 | 141 | 46900 | 17 | 140 | 709 | 866 | 39 | 12 | 51 |
| Minimum Value: | | | 7.60 | 139 | 33,708 | 17 | 42 | 169 | 493 | 39 | 12 | 51 |
| Maximum Value: | | | 8.32 | 190 | 47,415 | 365 | 467 | 709 | 924 | 133 | 157 | 278 |
| Geometric Mean Value: | | | 7.87 | 155 | 44,045 | 77 | 193 | 333 | 770 | 79 | 75 | 164 |
| | | | | | | | | | | | | |
| 2071 | SP-13 | 6/30/20 | 8.14 | 149 | 48,614 | 225 | 466 | 319 | 1,010 | 123 | 32 | 155 |
| 2826 | SP-13 | 8/31/20 | 7.63 | 150 | 44,833 | 213 | 119 | 495 | 827 | 114 | 20 | 134 |
| 3103 | SP-13 | 9/23/20 | 7.95 | 158 | 35,722 | 539 | 142 | 294 | 975 | 116 | 122 | 238 |
| 3740 | SP-13 | 11/30/20 | 7.57 | 157 | 46100 | 230 | 276 | 806 | 1312 | 122 | 67 | 189 |
| Minimum Value: | | | 7.57 | 149 | 35,722 | 213 | 119 | 294 | 827 | 114 | 20 | 134 |
| Maximum Value: | | | 8.14 | 158 | 48,614 | 539 | 466 | 806 | 1,312 | 123 | 122 | 238 |
| Geometric Mean Value: | | | 7.82 | 153 | 43,526 | 278 | 216 | 440 | 1,017 | 119 | 48 | 175 |
| | | | | | | | | | | | | |
| 2072 | SP-14 | 6/30/20 | 8.06 | 152 | 52,647 | 656 | 355 | 499 | 1,510 | 240 | 23 | 263 |
| 2409 | SP-14 | 7/27/20 | 7.72 | 133 | 48,510 | 359 | 470 | 597 | 1,426 | 188 | 56 | 244 |
| 2827 | SP-14 | 8/31/20 | 7.48 | 147 | 49,113 | 206 | 847 | 275 | 1,328 | 326 | 70 | 396 |
| 3104 | SP-14 | 9/23/20 | 7.86 | 161 | 44,202 | 740 | 470 | 444 | 1,654 | 168 | 192 | 360 |
| 3741 | SP-14 | 11/30/20 | 7.33 | 132 | 48300 | 514 | 667 | 108 | 1289 | 111 | 44 | 155 |
| Minimum Value: | | | 7.33 | 132 | 44,202 | 206 | 355 | 108 | 1,289 | 111 | 23 | 155 |
| Maximum Value: | | | 8.06 | 161 | 52,647 | 740 | 847 | 597 | 1,654 | 326 | 192 | 396 |
| Geometric Mean Value: | | | 7.69 | 145 | 48,479 | 450 | 536 | 330 | 1,436 | 194 | 60 | 269 |

Characteristics of Groundwater Seepage Samples Collected at Marco Island from May-November 2020

| Lab ID (20-xxxx) | Site | Date Collected | pH (s.u.) | Alkalinity (mg/L) | Cond (µmho/cm) | Ammonia N (µg/L) | NOx-N (µg/L) | Diss.Org. N (µg/L) | Total N (µg/L) | SRP (µg/L) | Diss.Org. P (µg/L) | Total P (µg/L) |
|------------------------------|-------|-------------------|--------------|----------------------|-------------------|---------------------|-----------------|-----------------------|-------------------|---------------|-----------------------|-------------------|
| 2073 | SP-15 | 6/30/20 | 7.93 | 160 | 52,102 | 282 | 173 | 659 | 1,114 | 119 | 42 | 161 |
| 2410 | SP-15 | 7/27/20 | 7.82 | 138 | 47,960 | 22 | 229 | 793 | 1,044 | 89 | 21 | 110 |
| 2828 | SP-15 | 8/31/20 | 7.51 | 161 | 46,866 | 75 | 379 | 508 | 962 | 143 | 24 | 167 |
| 3106 | SP-15 | 9/23/20 | 8.02 | 164 | 43,990 | 403 | 299 | 332 | 1,034 | 190 | 56 | 246 |
| 3742 | SP-15 | 11/30/20 | 7.53 | 147 | 45900 | 151 | 268 | 805 | 1224 | 87 | 77 | 164 |
| Minimum Value: | | | 7.51 | 138 | 43,990 | 22 | 173 | 332 | 962 | 87 | 21 | 110 |
| Maximum Value: | | | 8.02 | 164 | 52,102 | 403 | 379 | 805 | 1,224 | 190 | 77 | 246 |
| Geometric Mean Value: | | | 7.76 | 154 | 47,288 | 123 | 261 | 589 | 1,072 | 120 | 39 | 164 |

APPENDIX F

**CHARACTERISTICS OF MONITORED
INPUTS TO MARCO ISLAND WATERWAYS
FROM MAY-OCTOBER 2020**

F-1: Bulk Precipitation

F-2: Stormwater Runoff

F-3: Reuse Irrigation

F-4: Reuse Pond on Golf Course

F-1: Bulk Precipitation

Characteristics of Bulk Precipitation Samples Collected at Marco Island from June - October 2020

| Lab ID (20-xxxx) | Date Collected | pH (s.u.) | Alkalinity (mg/L) | Cond. (µmho/cm) | Ammonia N (µg/L) | NOx-N (µg/L) | Diss.Org. N (µg/L) | Part. N (µg/L) | Total N (µg/L) | Diss. TN (µg/L) | SRP (µg/L) | Diss.Org. P (µg/L) | Part. P (µg/L) | Total P (µg/L) | Diss. TP (µg/L) | Turbidity (NTU) | Color (Pt-Co) | TSS (mg/L) |
|---------------------|-------------------|--------------|----------------------|--------------------|---------------------|-----------------|-----------------------|-------------------|-------------------|--------------------|---------------|-----------------------|-------------------|-------------------|--------------------|--------------------|------------------|---------------|
| 1700 | 6/3/20 | 6.86 | 19.7 | 7 | 64 | 82 | 4 | 14 | 164 | 150 | 1 | 80 | 16 | 97 | 81 | 1.1 | 1 | 2.7 |
| 1753 | 6/9/20 | 6.32 | 13.8 | 17 | 9 | 92 | 187 | 38 | 326 | 288 | 4 | 88 | 20 | 112 | 92 | 0.8 | 2 | 1.1 |
| 1871 | 6/17/20 | 5.87 | 14.6 | 26 | 1,211 | 137 | 900 | 7 | 2,255 | 2,248 | 205 | 61 | 88 | 354 | 266 | 1.9 | 3 | 14.6 |
| 2016 | 6/25/20 | 6.13 | 12.8 | 15 | 149 | 148 | 75 | 47 | 419 | 372 | 5 | 36 | 38 | 79 | 41 | 0.8 | 1 | 1.0 |
| 2178 | 7/8/20 | 6.75 | 19.3 | 22 | 70 | 184 | 97 | 51 | 402 | 351 | 4 | 11 | 2 | 17 | 15 | 2.3 | 5 | 3.4 |
| 2310 | 7/16/20 | 6.59 | 14.8 | 18 | 66 | 137 | 36 | 29 | 268 | 239 | 5 | 18 | 5 | 28 | 23 | 1.7 | 1 | 3.0 |
| 2340 | 7/21/20 | 6.31 | 16.0 | 11 | 3 | 2 | 54 | 25 | 84 | 59 | 1 | 12 | 3 | 16 | 13 | 0.8 | 2 | 2.3 |
| 2394 | 7/27/20 | 6.49 | 18.9 | 8 | 3 | 87 | 43 | 47 | 180 | 133 | 1 | 13 | 6 | 20 | 14 | 0.6 | 1 | 0.7 |
| 2497 | 8/5/20 | 6.25 | 10.5 | 7 | 37 | 184 | 245 | 59 | 525 | 466 | 3 | 6 | 19 | 28 | 9 | 4.1 | 2 | 4.2 |
| 2557 | 8/12/20 | 6.29 | 13.7 | 18 | 3 | 160 | 18 | 49 | 230 | 181 | 7 | 35 | 13 | 55 | 42 | 2.1 | 1 | 2.5 |
| 2636 | 8/19/20 | 6.43 | 25.5 | 10 | 3 | 100 | 8 | 21 | 132 | 111 | 3 | 6 | 2 | 11 | 9 | 0.4 | 1 | 2.2 |
| 2709 | 8/23/20 | 6.14 | 13.0 | 31 | 19 | 141 | 195 | 26 | 381 | 355 | 4 | 26 | 27 | 57 | 30 | 0.6 | 1 | 1.3 |
| 2808 | 8/31/20 | 6.27 | 20.0 | 31 | 36 | 100 | 32 | 15 | 183 | 168 | 1 | 30 | 16 | 47 | 31 | 1.2 | 2 | 0.3 |
| 2917 | 9/10/20 | 6.23 | 16.5 | 19 | 4 | 113 | 35 | 58 | 210 | 152 | 1 | 10 | 4 | 15 | 11 | 0.9 | 1 | 5.2 |
| 2940 | 9/14/20 | 6.58 | 26.5 | 30 | 9 | 39 | 8 | 9 | 65 | 56 | 2 | 19 | 4 | 25 | 21 | 1.1 | 1 | 1.3 |
| 3451 | 10/19/20 | 6.31 | 28.0 | 18 | 138 | 184 | 17 | 33 | 372 | 339 | 63 | 21 | 6 | 90 | 84 | 0.7 | 1 | 6.3 |
| 3554 | 10/28/20 | 6.42 | 31.5 | 23 | 201 | 98 | 207 | 42 | 548 | 506 | 45 | 24 | 8 | 77 | 69 | 1.5 | 1 | 12.2 |
| Minimum Value: | | 5.87 | 10.5 | 7 | 3 | 2 | 4 | 7 | 65 | 56 | 1 | 6 | 2 | 11 | 9 | 0.4 | 1 | 0.3 |
| Maximum Value: | | 6.86 | 31.5 | 31 | 1,211 | 184 | 900 | 59 | 2,255 | 2,248 | 205 | 88 | 88 | 354 | 266 | 4.1 | 5 | 14.6 |
| Geometric Mean: | | 6.36 | 17.7 | 16 | 26 | 92 | 50 | 28 | 273 | 234 | 4 | 22 | 9 | 43 | 31 | 1.1 | 1 | 2.4 |

F-2: Stormwater Runoff

Characteristics of Stormwater Runoff Samples Collected at Marco Island from May - October 2020

| Lab ID | Location | Date Collected | Sample Type | pH (s.u.) | Alkalinity (mg/L) | Cond. (µmho/cm) | NH3-N (µg/L) | NOx-N (µg/L) | Diss.Org. N (µg/L) | Part. N (µg/L) | Total N (µg/L) | Diss. TN (µg/L) | SRP (µg/L) | Diss.Org. P (µg/L) | Part. P (µg/L) | Total P (µg/L) | Diss. TP (µg/L) | Turbidity (NTU) | Color (Pt-Co) | TSS (mg/L) | |
|-----------------|----------|----------------|-------------|-----------|-------------------|-----------------|--------------|--------------|--------------------|----------------|----------------|-----------------|------------|--------------------|----------------|----------------|-----------------|-----------------|---------------|------------|-------|
| 2631 | Site 1 | 8/19/20 | SW | 6.43 | 35.9 | 99 | 3 | 95 | 14 | 189 | 301 | 112 | 145 | 22 | 48 | 215 | 167 | 1.3 | 23 | 4.6 | |
| 2935 | | 9/14/20 | SW | 7.11 | 101 | 1,057 | 51 | 55 | 595 | 112 | 813 | 701 | 233 | 101 | 53 | 387 | 334 | 5.1 | 77 | 48.8 | |
| 3552 | | 10/28/20 | SW | 7.19 | 102 | 1,194 | 3 | 208 | 519 | 180 | 910 | 730 | 54 | 19 | 32 | 105 | 73 | 87.5 | 26 | 196.0 | |
| Minimum Value: | | | | 6.43 | 36 | 99 | 3 | 55 | 14 | 112 | 301 | 112 | 54 | 19 | 32 | 105 | 73 | 1.3 | 23 | 4.6 | |
| Maximum Value: | | | | 7.19 | 102 | 1,194 | 51 | 208 | 595 | 189 | 910 | 730 | 233 | 101 | 101 | 53 | 387 | 334 | 87.5 | 77 | 196.0 |
| Geometric Mean: | | | | 6.90 | 72 | 500 | 8 | 103 | 163 | 156 | 606 | 386 | 122 | 35 | 43 | 206 | 160 | 8.3 | 36 | 35.3 | |
| 1551 | Site 1 | 5/19/20 | BF | 7.89 | 104 | 41,724 | 61 | 119 | 658 | 165 | 1,003 | 838 | 75 | 16 | 44 | 135 | 91 | 9.7 | 20 | 20.8 | |
| 1638 | | 5/27/20 | BF | 7.85 | 144 | 51,984 | 88 | 176 | 421 | 354 | 1,039 | 685 | 75 | 16 | 15 | 106 | 91 | 18.9 | 18 | 29.3 | |
| 1696 | | 6/3/20 | BF | 8.21 | 84.2 | 28,930 | 92 | 93 | 477 | 5 | 667 | 662 | 72 | 87 | 16 | 175 | 159 | 3.4 | 17 | 5.3 | |
| 2335 | | 7/21/20 | BF | 7.67 | 150 | 23,210 | 172 | 107 | 459 | 109 | 847 | 738 | 49 | 7 | 6 | 62 | 56 | 1.3 | 32 | 0.8 | |
| 2389 | | 7/27/20 | BF | 7.42 | 117 | 35,310 | 147 | 102 | 470 | 43 | 762 | 719 | 80 | 9 | 2 | 91 | 89 | 5.2 | 18 | 7.7 | |
| 2492 | | 8/5/20 | BF | 7.81 | 157 | 23,868 | 3 | 80 | 810 | 88 | 981 | 893 | 25 | 5 | 9 | 39 | 30 | 1.7 | 21 | 4.4 | |
| 2554 | | 8/12/20 | BF | 7.96 | 126 | 28,997 | 3 | 435 | 532 | 113 | 1,083 | 970 | 122 | 8 | 5 | 135 | 130 | 5.2 | 16 | 13.2 | |
| 3078 | | 9/23/20 | BF | 7.62 | 131 | 43,977 | 19 | 159 | 385 | 55 | 618 | 563 | 40 | 6 | 16 | 62 | 46 | 2.3 | 25 | 10.8 | |
| 3169 | | 9/28/20 | BF | 7.58 | 122 | 27,878 | 40 | 105 | 358 | 33 | 536 | 503 | 133 | 10 | 25 | 168 | 143 | 3.6 | 14 | 3.5 | |
| 3239 | | 10/5/20 | BF | 7.46 | 130 | 29,256 | 249 | 195 | 433 | 101 | 978 | 877 | 94 | 20 | 20 | 134 | 114 | 27.4 | 29 | 300.0 | |
| 3323 | | 10/12/20 | BF | 7.59 | 133 | 40,664 | 116 | 135 | 872 | 1,302 | 2,425 | 1,123 | 168 | 37 | 73 | 278 | 205 | 304.7 | 41 | 591.0 | |
| Minimum Value: | | | | 7.42 | 84 | 23,210 | 3 | 80 | 358 | 5 | 536 | 503 | 25 | 5 | 2 | 39 | 30 | 1.3 | 14 | 0.8 | |
| Maximum Value: | | | | 8.21 | 157 | 51,984 | 249 | 435 | 872 | 1,302 | 2,425 | 1,123 | 168 | 87 | 73 | 278 | 205 | 304.7 | 41 | 591.0 | |
| Geometric Mean: | | | | 7.73 | 125 | 33,080 | 47 | 137 | 512 | 90 | 915 | 760 | 75 | 13 | 14 | 110 | 92 | 7.2 | 22 | 14.9 | |
| 2306 | Site 2 | 7/16/20 | SW | 7.37 | 50.4 | 3,718 | 37 | 133 | 115 | 166 | 451 | 285 | 123 | 20 | 131 | 274 | 143 | 13.7 | 23 | 72.6 | |
| 2336 | | 7/21/20 | SW | 7.18 | 22.3 | 1,581 | 28 | 23 | 120 | 135 | 306 | 171 | 101 | 5 | 23 | 129 | 106 | 1.8 | 21 | 9.6 | |
| 2493 | | 8/5/20 | SW | 7.90 | 96.1 | 1,117 | 3 | 2 | 686 | 36 | 727 | 691 | 25 | 4 | 5 | 34 | 29 | 1.9 | 11 | 7.6 | |
| 2555 | | 8/12/20 | SW | 7.67 | 109.0 | 1,464 | 3 | 101 | 522 | 49 | 675 | 626 | 147 | 35 | 28 | 210 | 182 | 0.7 | 16 | 1.9 | |
| 2936 | | 9/14/20 | SW | 7.32 | 119.0 | 1,441 | 3 | 2 | 277 | 47 | 329 | 282 | 119 | 43 | 14 | 176 | 162 | 0.8 | 34 | 8.7 | |
| Minimum Value: | | | | 7.18 | 22 | 1,117 | 3 | 2 | 115 | 36 | 306 | 171 | 25 | 4 | 5 | 34 | 29 | 0.7 | 11 | 1.9 | |
| Maximum Value: | | | | 7.90 | 119 | 3,718 | 37 | 133 | 686 | 166 | 727 | 691 | 147 | 43 | 43 | 131 | 274 | 182 | 13.7 | 34 | 72.6 |
| Geometric Mean: | | | | 7.48 | 67 | 1,692 | 8 | 17 | 267 | 71 | 467 | 359 | 89 | 14 | 23 | 135 | 105 | 1.9 | 20 | 9.7 | |
| 1639 | Site 2 | 5/27/20 | BF | 7.79 | 137.0 | 53,352 | 87 | 82 | 429 | 230 | 828 | 598 | 147 | 26 | 17 | 190 | 173 | 1.5 | 14 | 8.1 | |
| 2015 | | 6/25/20 | BF | 7.75 | 140.0 | 48,941 | 3 | 2 | 602 | 167 | 774 | 607 | 112 | 26 | 155 | 293 | 138 | 3.4 | 16 | 16.2 | |
| 2054 | | 6/30/20 | BF | 7.76 | 134.0 | 50,794 | 3 | 23 | 496 | 18 | 540 | 522 | 49 | 8 | 22 | 79 | 57 | 1.2 | 7 | 2.7 | |
| 2175 | | 7/8/20 | BF | 7.82 | 150.0 | 48,950 | 22 | 3 | 499 | 51 | 575 | 524 | 41 | 10 | 8 | 59 | 51 | 1.5 | 11 | 4.9 | |
| 2390 | | 7/27/20 | BF | 7.82 | 127.0 | 21,670 | 39 | 2 | 530 | 20 | 591 | 571 | 100 | 11 | 17 | 128 | 111 | 1.4 | 9 | 4.1 | |
| 2632 | | 8/19/20 | BF | 7.81 | 120.0 | 37,129 | 3 | 107 | 616 | 52 | 778 | 726 | 93 | 19 | 42 | 154 | 112 | 1.3 | 16 | 2.8 | |
| 2705 | | 8/23/20 | BF | 7.76 | 123.0 | 47,064 | 3 | 40 | 555 | 72 | 670 | 598 | 34 | 16 | 7 | 57 | 50 | 0.5 | 9 | 3.9 | |
| 2914 | | 9/10/20 | BF | 7.81 | 111.0 | 52,644 | 3 | 2 | 421 | 190 | 616 | 426 | 266 | 33 | 35 | 334 | 299 | 0.8 | 12 | 3.7 | |
| 3079 | | 9/23/20 | BF | 7.78 | 138.0 | 43,228 | 43 | 147 | 345 | 29 | 564 | 535 | 72 | 13 | 13 | 98 | 85 | 1.6 | 13 | 4.5 | |
| 3324 | | 10/12/20 | BF | 7.92 | 136.0 | 43,784 | 3 | 50 | 856 | 34 | 943 | 909 | 41 | 18 | 9 | 68 | 59 | 4.3 | 10 | 10.6 | |
| 3447 | | 10/19/20 | BF | 7.63 | 136.0 | 52,520 | 34 | 30 | 428 | 21 | 513 | 492 | 94 | 8 | 21 | 123 | 102 | 0.8 | 6 | 3.3 | |
| Minimum Value: | | | | 7.63 | 111 | 21,670 | 3 | 2 | 345 | 18 | 513 | 426 | 34 | 8 | 7 | 57 | 50 | 0.5 | 6 | 2.7 | |
| Maximum Value: | | | | 7.92 | 150 | 53,352 | 87 | 147 | 856 | 230 | 943 | 909 | 266 | 33 | 33 | 334 | 299 | 4.3 | 16 | 16.2 | |
| Geometric Mean: | | | | 7.79 | 132 | 44,290 | 10 | 17 | 511 | 54 | 660 | 580 | 79 | 15 | 20 | 121 | 96 | 1.4 | 11 | 5.0 | |

Characteristics of Stormwater Runoff Samples Collected at Marco Island from May - October 2020

| Lab ID | Location | Date Collected | Sample Type | pH (s.u.) | Alkalinity (mg/L) | Cond. (µmho/cm) | NH3-N (µg/L) | NOx-N (µg/L) | Diss.Org. N (µg/L) | Part. N (µg/L) | Total N (µg/L) | SRP (µg/L) | Diss.Org. P (µg/L) | Part. P (µg/L) | Total P (µg/L) | Diss. TP (µg/L) | Turbidity (NTU) | Color (Pt-Co) | TSS (mg/L) | | |
|-----------------|----------|----------------|-------------|-----------|-------------------|-----------------|--------------|--------------|--------------------|----------------|----------------|------------|--------------------|----------------|----------------|-----------------|-----------------|---------------|------------|-------|--|
| 1552 | | 5/19/20 | SW | 8.75 | 25.1 | 967 | 1,252 | 288 | 404 | 193 | 2,137 | 63 | 40 | 40 | 143 | 103 | 6.9 | 54 | 7.6 | | |
| 1698 | | 6/3/20 | SW | 7.97 | 24.8 | 1,191 | 1,442 | 69 | 844 | 719 | 3,074 | 49 | 85 | 227 | 361 | 134 | 39.0 | 75 | 67.2 | | |
| 1751 | | 6/9/20 | SW | 8.59 | 246 | 738 | 833 | 863 | 690 | 360 | 2,746 | 103 | 96 | 301 | 500 | 199 | 10.6 | 53 | 25.9 | | |
| 1869 | | 6/17/20 | SW | 6.99 | 268 | 2,000 | 1,417 | 6 | 1,020 | 239 | 2,682 | 42 | 41 | 308 | 391 | 83 | 25.4 | 57 | 10.2 | | |
| 2337 | Site 3 | 7/21/20 | SW | 7.07 | 163 | 1,064 | 970 | 94 | 286 | 94 | 1,444 | 34 | 35 | 41 | 110 | 69 | 1.5 | 34 | 4.1 | | |
| 2494 | | 8/5/20 | SW | 7.42 | 127 | 747 | 306 | 45 | 354 | 10 | 715 | 34 | 105 | 46 | 185 | 139 | 3.6 | 40 | 2.4 | | |
| 2633 | | 8/19/20 | SW | 7.21 | 22.8 | 97 | 3 | 66 | 379 | 39 | 487 | 242 | 38 | 10 | 290 | 280 | 1.2 | 43 | 2.5 | | |
| 2706 | | 8/23/20 | SW | 7.24 | 48.0 | 3,127 | 3 | 357 | 29 | 160 | 134 | 523 | 110 | 44 | 39 | 193 | 154 | 1.4 | 19 | 7.9 | |
| 2915 | | 9/10/20 | SW | 7.37 | 41.9 | 268 | 10 | 256 | 160 | 179 | 203 | 629 | 141 | 30 | 22 | 193 | 171 | 1.7 | 19 | 5.8 | |
| 2937 | | 9/14/20 | SW | 6.69 | 49.2 | 127 | 3 | 178 | 179 | 179 | 55 | 415 | 105 | 51 | 8 | 164 | 156 | 2.4 | 23 | 11.9 | |
| Minimum Value: | | | | 6.69 | 22.8 | 97 | 3 | 6 | 29 | 10 | 415 | 34 | 30 | 8 | 110 | 69 | 1.2 | 19 | 2.4 | | |
| Maximum Value: | | | | 8.75 | 268 | 3,127 | 1,442 | 863 | 1,020 | 719 | 3,074 | 242 | 2,443 | 105 | 308 | 500 | 280 | 39.0 | 75 | 67.2 | |
| Geometric Mean: | | | | 7.50 | 67.3 | 652 | 105 | 117 | 308 | 121 | 1,128 | 962 | 76 | 51 | 51 | 227 | 138 | 4.4 | 38 | 8.4 | |
| 1640 | | | 5/27/20 | BF | 7.33 | 189 | 32,604 | 668 | 264 | 194 | 175 | 1,301 | 81 | 37 | 10 | 128 | 118 | 4.6 | 42 | 15.0 | |
| 2055 | | 6/30/20 | BF | 7.42 | 204 | 26,269 | 1,102 | 2 | 310 | 146 | 1,560 | 57 | 21 | 30 | 108 | 78 | 10.7 | 58 | 5.2 | | |
| 2176 | | 7/8/20 | BF | 7.29 | 201 | 29,150 | 974 | 17 | 69 | 282 | 1,342 | 124 | 3 | 25 | 152 | 127 | 6.1 | 42 | 4.9 | | |
| 2307 | Site 3 | 7/16/20 | BF | 6.82 | 217 | 22,220 | 1,218 | 12 | 71 | 273 | 1,574 | 59 | 9 | 211 | 279 | 68 | 8.2 | 45 | 13.3 | | |
| 2391 | | 7/27/20 | BF | 6.94 | 208 | 24,860 | 1,423 | 2 | 368 | 133 | 1,926 | 98 | 25 | 62 | 185 | 123 | 5.8 | 65 | 9.7 | | |
| 3080 | | 9/23/20 | BF | 7.11 | 142 | 30,602 | 1,039 | 16 | 623 | 121 | 1,799 | 43 | 99 | 62 | 204 | 142 | 4.2 | 54 | 8.5 | | |
| 3448 | | 10/19/20 | BF | 7.20 | 138 | 38,896 | 186 | 737 | 250 | 65 | 1,238 | 105 | 18 | 59 | 182 | 123 | 9.7 | 26 | 19.7 | | |
| Minimum Value: | | | | 6.82 | 138 | 22,220 | 186 | 2 | 69 | 65 | 1,238 | 43 | 3 | 10 | 108 | 68 | 4.2 | 26 | 4.9 | | |
| Maximum Value: | | | | 7.42 | 217 | 38,896 | 1,423 | 737 | 623 | 282 | 1,926 | 1,24 | 124 | 99 | 211 | 279 | 142 | 10.7 | 65 | 19.7 | |
| Geometric Mean: | | | | 7.16 | 183 | 28,795 | 816 | 22 | 208 | 154 | 1,516 | 1,340 | 76 | 19 | 45 | 170 | 108 | 6.7 | 46 | 9.7 | |
| 1699 | | 6/3/20 | SW | 7.99 | 314.0 | 2,376 | 332 | 82 | 758 | 8 | 1,180 | 257 | 68 | 75 | 400 | 325 | 5.6 | 61 | 7.8 | | |
| 1752 | | 6/9/20 | SW | 8.26 | 343.0 | 1,824 | 441 | 26 | 859 | 8 | 1,334 | 301 | 53 | 30 | 384 | 354 | 7.4 | 61 | 20.1 | | |
| 1870 | | 6/17/20 | SW | 6.93 | 33.2 | 90 | 60 | 137 | 269 | 63 | 529 | 228 | 42 | 45 | 315 | 270 | 12.9 | 33 | 17.5 | | |
| 2308 | Site 4 | 7/16/20 | SW | 7.69 | 124.0 | 474 | 70 | 357 | 171 | 191 | 789 | 285 | 39 | 142 | 466 | 324 | 9.9 | 55 | 25.0 | | |
| 2338 | | 7/21/20 | SW | 7.61 | 64.2 | 1,420 | 36 | 225 | 281 | 351 | 893 | 201 | 18 | 125 | 344 | 219 | 44.8 | 71 | 78.0 | | |
| 2495 | | 8/5/20 | SW | 7.78 | 45.0 | 1,206 | 32 | 331 | 611 | 247 | 1,221 | 974 | 127 | 203 | 461 | 330 | 28.8 | 114 | 39.9 | | |
| 2938 | | 9/14/20 | SW | 7.40 | 133.0 | 906 | 330 | 65 | 746 | 75 | 1,216 | 1,141 | 89 | 142 | 303 | 231 | 17.5 | 86 | 47.0 | | |
| 3325 | | 10/12/20 | SW | 7.53 | 51.9 | 887 | 100 | 1,075 | 922 | 321 | 2,418 | 2,097 | 630 | 101 | 160 | 891 | 731 | 11.3 | 49 | 25.8 | |
| Minimum Value: | | | | 6.93 | 33 | 90 | 32 | 26 | 171 | 8 | 529 | 466 | 89 | 18 | 30 | 303 | 219 | 5.6 | 33 | 7.8 | |
| Maximum Value: | | | | 8.26 | 343 | 2,376 | 441 | 1,075 | 922 | 351 | 2,418 | 2,097 | 630 | 203 | 160 | 891 | 731 | 44.8 | 114 | 78.0 | |
| Geometric Mean: | | | | 7.64 | 98 | 843 | 111 | 165 | 494 | 80 | 1,098 | 927 | 228 | 65 | 85 | 420 | 324 | 13.8 | 62 | 26.7 | |
| 1641 | | 5/27/20 | BF | 7.87 | 265.0 | 16,997 | 544 | 12 | 516 | 157 | 1,229 | 1,098 | 79 | 220 | 1,397 | 1,177 | 4.6 | 79 | 5.8 | | |
| 2177 | | 7/8/20 | BF | 8.31 | 326.0 | 5,379 | 538 | 620 | 216 | 221 | 1,595 | 289 | 61 | 78 | 428 | 350 | 3.3 | 70 | 23.6 | | |
| 2392 | | 7/27/20 | BF | 7.83 | 113.0 | 26,950 | 79 | 167 | 216 | 303 | 765 | 143 | 36 | 23 | 202 | 179 | 24.6 | 26 | 36.8 | | |
| 2634 | Site 4 | 8/19/20 | BF | 7.54 | 156.0 | 41,409 | 162 | 79 | 991 | 361 | 1,593 | 207 | 501 | 285 | 993 | 708 | 0.4 | 23 | 8.5 | | |
| 2707 | | 8/23/20 | BF | 7.72 | 124.0 | 40,386 | 127 | 133 | 645 | 335 | 1,240 | 122 | 4 | 52 | 178 | 126 | 7.3 | 17 | 13.7 | | |
| 3081 | | 9/23/20 | BF | 7.42 | 59.1 | 35,952 | 50 | 435 | 227 | 113 | 825 | 712 | 82 | 25 | 118 | 93 | 1.1 | 26 | 4.3 | | |
| 3170 | | 9/28/20 | BF | 7.99 | 225.0 | 42,506 | 347 | 850 | 288 | 288 | 138 | 1,623 | 323 | 9 | 17 | 349 | 332 | 16.4 | 59 | 43.2 | |
| 3240 | | 10/5/20 | BF | 7.87 | 128.0 | 19,854 | 86 | 616 | 239 | 239 | 673 | 1,614 | 208 | 58 | 232 | 498 | 266 | 98.9 | 24 | 471.0 | |
| 3449 | 10/19/20 | BF | 7.34 | 60.9 | 41,912 | 229 | 128 | 283 | 84 | 724 | 640 | 95 | 4 | 9 | 108 | 99 | 0.5 | 14 | 1.5 | | |
| Minimum Value: | | | | 7.34 | 59.1 | 5,379 | 50 | 12 | 216 | 84 | 724 | 462 | 82 | 4 | 9 | 108 | 93 | 0.4 | 14 | 1.5 | |
| Maximum Value: | | | | 8.31 | 326 | 42,506 | 544 | 850 | 991 | 673 | 1,623 | 1,485 | 1,098 | 501 | 285 | 1,397 | 1,177 | 98.9 | 79 | 471.0 | |
| Geometric Mean: | | | | 7.76 | 139.2 | 25,897 | 176 | 194 | 344 | 218 | 1,186 | 922 | 204 | 27 | 56 | 331 | 260 | 4.6 | 31 | 16.2 | |

Characteristics of Stormwater Runoff Samples Collected at Marco Island from May - October 2020

| Lab ID | Location | Date Collected | Sample Type | pH (s.u.) | Alkalinity (mg/L) | Cond. (µmho/cm) | NH3-N (µg/L) | NOx-N (µg/L) | Diss.Org. N (µg/L) | Part. N (µg/L) | Total N (µg/L) | Diss. TN (µg/L) | SRP (µg/L) | Diss.Org. P (µg/L) | Part. P (µg/L) | Total P (µg/L) | Diss. TP (µg/L) | Turbidity (NTU) | Color (Pt-Co) | TSS (mg/L) |
|--------|----------|----------------|-------------|--|-------------------|-----------------|--------------|--------------|--------------------|----------------|----------------|-----------------|------------|--------------------|----------------|----------------|-----------------|-----------------|---------------|------------|
| 2635 | | 8/19/20 | SW | 7.93 | 51.8 | 163 | 3 | 101 | 76 | 36 | 216 | 180 | 35 | 77 | 19 | 131 | 112 | 13.1 | 21 | 22.8 |
| 2708 | | 8/23/20 | SW | 7.62 | 50.9 | 242 | 21 | 70 | 623 | 87 | 801 | 714 | 59 | 56 | 30 | 145 | 115 | 7.1 | 22 | 7.9 |
| 2916 | Site 5 | 9/10/20 | SW | 7.41 | 52.1 | 669 | 155 | 61 | 382 | 211 | 809 | 598 | 164 | 27 | 69 | 260 | 191 | 1.7 | 48 | 2.5 |
| 2939 | | 9/14/20 | SW | 7.84 | 61.9 | 263 | 35 | 2 | 284 | 53 | 374 | 321 | 23 | 51 | 38 | 112 | 74 | 6.5 | 39 | 5.5 |
| 3241 | | 10/5/20 | SW | 7.59 | 164 | 4,950 | 76 | 393 | 238 | 26 | 733 | 707 | 163 | 105 | 8 | 276 | 268 | 16.9 | 34 | 9.8 |
| | | | | Minimum Value: 7.41 51 163 3 2 76 26 216 180 23 27 8 112 74 1.7 21 2.5 Maximum Value: 7.93 164 4,950 155 393 211 809 714 164 105 268 268 16.9 137 7.0 31 7.5 Geometric Mean: 7.68 67 510 30 51 62 521 445 66 57 26 172 137 7.0 31 7.5 | | | | | | | | | | | | | | | | |
| 2309 | | 7/16/20 | BF | 8.27 | 179.0 | 36,410 | 45 | 162 | 345 | 105 | 657 | 552 | 197 | 24 | 5 | 226 | 221 | 1.3 | 20 | 2.5 |
| 2339 | | 7/21/20 | BF | 7.69 | 268.0 | 30,910 | 401 | 17 | 498 | 79 | 995 | 916 | 94 | 3 | 40 | 137 | 97 | 3.4 | 62 | 3.8 |
| 2393 | | 7/27/20 | BF | 8.74 | 262.0 | 30,910 | 75 | 272 | 430 | 88 | 865 | 777 | 205 | 37 | 26 | 268 | 242 | 2.4 | 53 | 2.2 |
| 2496 | | 8/5/20 | BF | 7.11 | 160.0 | 29,376 | 60 | 104 | 490 | 96 | 750 | 654 | 43 | 88 | 17 | 148 | 131 | 18.0 | 54 | 8.0 |
| 2556 | Site 5 | 8/12/20 | BF | 8.45 | 145.0 | 33,277 | 3 | 284 | 362 | 61 | 710 | 649 | 112 | 55 | 3 | 170 | 167 | 57.0 | 41 | 34.0 |
| 3082 | | 9/23/20 | BF | 7.74 | 173.0 | 24,075 | 39 | 528 | 151 | 60 | 778 | 718 | 136 | 12 | 29 | 177 | 148 | 2.4 | 29 | 4.9 |
| 3171 | | 9/28/20 | BF | 7.68 | 218.0 | 17,914 | 17 | 864 | 168 | 17 | 1,066 | 1,049 | 332 | 27 | 14 | 373 | 359 | 0.9 | 29 | 1.6 |
| 3326 | | 10/12/20 | BF | 7.82 | 165.0 | 28,704 | 3 | 737 | 673 | 39 | 1,452 | 1,413 | 419 | 6 | 12 | 437 | 425 | 1.8 | 22 | 4.3 |
| 3450 | | 10/19/20 | BF | 7.79 | 164.0 | 41,392 | 325 | 231 | 61 | 40 | 657 | 617 | 125 | 9 | 7 | 141 | 134 | 1.8 | 13 | 3.1 |
| 3553 | | 10/28/20 | BF | 7.93 | 64.1 | 33,624 | 3 | 325 | 377 | 105 | 810 | 705 | 217 | 4 | 59 | 280 | 221 | 2.1 | 20 | 39.8 |
| | | | | Minimum Value: 7.11 64.1 17,914 3 17 17 657 552 43 3 3 137 97 0.9 13 1.6 Maximum Value: 8.74 268 41,392 401 864 105 1,452 1,413 419 88 59 437 425 57.0 62 39.8 Geometric Mean: 7.91 169.1 29,977 29 237 61 848 774 157 16 218 194 3.3 31 5.5 | | | | | | | | | | | | | | | | |

F-3: Reuse Irrigation

Characteristics of Reuse Irrigation Samples Collected at Marco Island from May - October 2020

| Lab ID | Location | Date Collected | Sample Type | pH (s.u.) | Alkalinity (mg/L) | Cond. (µmho/cm) | NH3-N (µg/L) | NOx-N (µg/L) | Diss.Org. N (µg/L) | Part. N (µg/L) | Total N (µg/L) | Diss. TN (µg/L) | SRP (µg/L) | Diss.Org. P (µg/L) | Part. P (µg/L) | Total P (µg/L) | Diss. TP (µg/L) | Turbidity (NTU) | Color (Pt-Co) | TSS (mg/L) |
|-----------------|----------|----------------|-------------|-----------|-------------------|-----------------|--------------|--------------|--------------------|----------------|----------------|-----------------|------------|--------------------|----------------|----------------|-----------------|-----------------|---------------|------------|
| 1550 | | 5/19/20 | SW | 7.21 | 77.8 | 1,422 | 29 | 7,242 | 505 | 58 | 7,834 | 7,776 | 2,909 | 768 | 477 | 4,174 | 3,687 | 0.4 | 2 | 0.4 |
| 1637 | | 5/27/20 | SW | 7.44 | 104.0 | 1,831 | 26 | 3,012 | 448 | 242 | 3,728 | 3,486 | 3,082 | 579 | 301 | 3,962 | 3,661 | 0.3 | 6 | 0.4 |
| 1695 | | 6/3/20 | SW | 7.56 | 83.6 | 1,243 | 18 | 3,648 | 701 | 57 | 4,424 | 4,367 | 2,091 | 881 | 52 | 3,024 | 2,972 | 0.3 | 5 | 0.3 |
| 1750 | | 6/9/20 | SW | 7.47 | 111.0 | 1,467 | 9 | 3,747 | 762 | 75 | 4,593 | 4,518 | 3,068 | 1,240 | 4 | 4,312 | 4,308 | 0.3 | 9 | 0.4 |
| 1868 | | 6/17/20 | SW | 7.31 | 95.0 | 1,270 | 29 | 4,139 | 364 | 92 | 4,624 | 4,532 | 2,240 | 1,489 | 79 | 3,808 | 3,729 | 0.2 | 4 | 0.2 |
| 2014 | | 6/25/20 | SW | 7.42 | 111.0 | 1,242 | 14 | 3,226 | 140 | 300 | 3,680 | 3,380 | 3,382 | 182 | 41 | 3,605 | 3,564 | 0.4 | 6 | 0.2 |
| 2053 | | 6/30/20 | SW | 7.49 | 98.6 | 1,571 | 27 | 4,572 | 565 | 36 | 5,200 | 5,164 | 2,854 | 191 | 88 | 3,133 | 3,045 | 0.4 | 3 | 0.3 |
| 2174 | | 7/8/20 | SW | 7.28 | 94.8 | 1,475 | 34 | 2,716 | 888 | 12 | 3,650 | 3,638 | 3,284 | 407 | 260 | 3,951 | 3,691 | 0.4 | 6 | 0.2 |
| 2305 | | 7/16/20 | SW | 7.34 | 87.2 | 1,173 | 37 | 3,240 | 138 | 309 | 3,724 | 3,415 | 4,708 | 270 | 64 | 5,042 | 4,978 | 0.3 | 5 | 0.3 |
| 2334 | | 7/21/20 | SW | 7.19 | 93.1 | 1,311 | 22 | 800 | 2,983 | 785 | 4,590 | 3,805 | 604 | 2,086 | 45 | 2,735 | 2,690 | 1.9 | 10 | 1.0 |
| 2388 | | 7/27/20 | SW | 7.36 | 101.0 | 1,308 | 23 | 2,932 | 81 | 93 | 3,129 | 3,036 | 2,382 | 194 | 132 | 2,708 | 2,576 | 0.4 | 6 | 0.3 |
| 2491 | | 8/5/20 | SW | 7.49 | 106.0 | 1,327 | 4 | 806 | 2,065 | 25 | 2,900 | 2,875 | 531 | 1,548 | 202 | 2,281 | 2,079 | 0.2 | 6 | 0.6 |
| 2553 | | 8/12/20 | SW | 7.45 | 98.2 | 1,379 | 3 | 6,935 | 660 | 324 | 7,922 | 7,598 | 3,121 | 30 | 294 | 3,445 | 3,151 | 0.3 | 6 | 0.4 |
| 2630 | | 8/19/20 | SW | 7.38 | 96.7 | 1,283 | 3 | 3,631 | 653 | 68 | 4,355 | 4,287 | 2,715 | 270 | 54 | 3,039 | 2,985 | 0.4 | 9 | 0.2 |
| 2704 | | 8/23/20 | SW | 7.41 | 111.0 | 1,356 | 3 | 3,163 | 513 | 1,672 | 5,351 | 3,679 | 3,380 | 190 | 250 | 3,820 | 3,570 | 0.5 | 9 | 0.2 |
| 2807 | | 8/31/20 | SW | 7.63 | 101.0 | 1,594 | 94 | 3,883 | 85 | 327 | 4,389 | 4,062 | 3,907 | 311 | 242 | 4,460 | 4,218 | 0.3 | 3 | 0.3 |
| 2913 | | 9/10/20 | SW | 7.53 | 126.0 | 1,436 | 3 | 5,161 | 134 | 194 | 5,492 | 5,298 | 3,399 | 1,828 | 332 | 5,559 | 5,227 | 0.5 | 9 | 0.3 |
| 2934 | | 9/14/20 | SW | 7.24 | 103.0 | 1,191 | 5 | 4,326 | 196 | 211 | 4,738 | 4,527 | 2,085 | 226 | 183 | 2,494 | 2,311 | 0.5 | 7 | 0.2 |
| 3077 | | 9/23/20 | SW | 7.09 | 94.4 | 1,596 | 3 | 7,105 | 561 | 533 | 8,202 | 7,669 | 1,763 | 111 | 165 | 2,039 | 1,874 | 0.5 | 4 | 0.2 |
| 3168 | | 9/28/20 | SW | 7.15 | 101.0 | 1,338 | 30 | 7,375 | 781 | 321 | 8,507 | 8,186 | 1,985 | 1,168 | 32 | 3,185 | 3,153 | 0.3 | 5 | 0.1 |
| 3238 | | 10/5/20 | SW | 7.19 | 99.1 | 935 | 3 | 4,216 | 893 | 407 | 5,519 | 5,112 | 2,471 | 165 | 344 | 2,980 | 2,636 | 0.6 | 4 | 0.3 |
| 3322 | | 10/12/20 | SW | 7.14 | 100.0 | 1,933 | 12 | 4,478 | 1,459 | 41 | 5,990 | 5,949 | 2,338 | 120 | 260 | 2,718 | 2,458 | 0.2 | 4 | 0.2 |
| 3446 | | 10/19/20 | SW | 7.14 | 98.2 | 1,557 | 13 | 3,410 | 293 | 259 | 3,975 | 3,716 | 2,689 | 207 | 187 | 3,083 | 2,896 | 0.2 | 1 | 0.2 |
| 3551 | | 10/28/20 | SW | 7.82 | 98.7 | 1,688 | 4 | 300 | 1,206 | 123 | 1,633 | 1,510 | 759 | 866 | 118 | 1,743 | 1,625 | 0.1 | 1 | 0.6 |
| Minimum Value: | | | | 7.09 | 77.8 | 935 | 3 | 300 | 81 | 12 | 1,633 | 1,510 | 531 | 30 | 4 | 1,743 | 1,625 | 0.1 | 1 | 0.1 |
| Maximum Value: | | | | 7.82 | 126 | 1,933 | 94 | 7,375 | 2,983 | 1,672 | 8,507 | 8,186 | 4,708 | 2,086 | 477 | 5,559 | 5,227 | 1.9 | 10 | 1.0 |
| Geometric Mean: | | | | 7.36 | 99.1 | 1,397 | 11 | 3,263 | 479 | 150 | 4,629 | 4,356 | 2,300 | 391 | 121 | 3,267 | 3,090 | 0.3 | 5 | 0.3 |

F-4: Reuse Pond on Golf Course

Characteristics of Reuse Irrigation Samples Collected at Marco Island from May - October 2020

| Lab ID | Location | Date Collected | Sample Type | pH (s.u.) | Alkalinity (mg/L) | Cond. (µmho/cm) | NH3-N (µg/L) | NOx-N (µg/L) | Diss.Org. N (µg/L) | Part. N (µg/L) | Total N (µg/L) | Diss. TN (µg/L) | SRP (µg/L) | Diss.Org. P (µg/L) | Part. P (µg/L) | Total P (µg/L) | Diss. TP (µg/L) | Turbidity (NTU) | Color (Pt-Co) | TSS (mg/L) |
|-----------------|----------|----------------|-------------|-----------|-------------------|-----------------|--------------|--------------|--------------------|----------------|----------------|-----------------|------------|--------------------|----------------|----------------|-----------------|-----------------|---------------|------------|
| 2498 | | 8/5/20 | Outfall | 7.39 | 135 | 1,237 | 110 | 2 | 1,066 | 899 | 2,077 | 1,178 | 53 | 92 | 142 | 287 | 145 | 14.2 | 100 | 12.0 |
| 2637 | | 8/19/20 | Outfall | 7.89 | 133 | 1,773 | 72 | 290 | 1,215 | 1,176 | 2,753 | 1,577 | 160 | 505 | 27 | 692 | 665 | 3.8 | 99 | 11.6 |
| 2558 | | 8/12/20 | Outfall | 7.06 | 122 | 16,157 | 475 | 2 | 1,594 | 1,527 | 3,598 | 2,071 | 179 | 300 | 179 | 658 | 479 | 8.6 | 149 | 12.2 |
| 2710 | | 8/23/20 | Outfall | 7.21 | 138 | 19,186 | 372 | 2 | 3,601 | 561 | 4,536 | 3,975 | 171 | 61 | 173 | 405 | 232 | 8.5 | 111 | 9.7 |
| 2809 | | 8/31/20 | Outfall | 7.82 | 154 | 24,824 | 113 | 2 | 736 | 262 | 1,113 | 851 | 95 | 22 | 51 | 168 | 117 | 2.6 | 104 | 7.1 |
| 2918 | | 9/10/20 | Outfall | 7.62 | 123 | 1,757 | 264 | 2 | 1,309 | 296 | 1,871 | 1,575 | 170 | 159 | 216 | 545 | 329 | 3.6 | 136 | 15.4 |
| 2941 | | 9/14/20 | Outfall | 7.72 | 128 | 3,681 | 328 | 2 | 956 | 262 | 1,548 | 1,286 | 131 | 253 | 308 | 692 | 384 | 2.2 | 104 | 19.5 |
| 3083 | | 9/23/20 | Outfall | 7.53 | 132 | 15,750 | 330 | 2 | 546 | 644 | 1,522 | 878 | 225 | 26 | 20 | 271 | 251 | 3.3 | 118 | 15.6 |
| 3172 | | 9/28/20 | Outfall | 7.45 | 152 | 13,155 | 244 | 2 | 490 | 466 | 1,202 | 736 | 169 | 567 | 19 | 755 | 736 | 2.7 | 104 | 8.0 |
| 3243 | | 10/5/20 | Outfall | 7.14 | 148 | 13,420 | 643 | 45 | 729 | 182 | 1,599 | 1,417 | 170 | 169 | 34 | 373 | 339 | 4.3 | 127 | 4.1 |
| 3327 | | 10/12/20 | Outfall | 7.41 | 129 | 24,128 | 416 | 132 | 1,200 | 781 | 2,529 | 1,748 | 190 | 16 | 42 | 248 | 206 | 8.1 | 82 | 7.0 |
| 3452 | | 10/19/20 | Outfall | 7.61 | 129 | 29,016 | 445 | 105 | 418 | 161 | 1,129 | 968 | 161 | 46 | 43 | 250 | 207 | 1.7 | 68 | 3.6 |
| 3555 | | 10/28/20 | Outfall | 7.63 | 121 | x | 666 | 31 | 765 | 14 | 1,476 | 1,462 | 54 | 230 | 72 | 356 | 284 | 2.2 | 71 | 4.3 |
| Minimum Value: | | | | | | | | | | | | | | | | | | | | |
| Maximum Value: | | | | | | | | | | | | | | | | | | | | |
| Geometric Mean: | | | | | | | | | | | | | | | | | | | | |

APPENDIX G

**RESULTS OF BENTHIC
SEDIMENT RELEASE EXPERIMENTS**

G-1: Lab Analyses Conducted During Sediment Release Experiments

G-2: Sediment Nutrient Release Plots

G-1: Lab Analyses Conducted During Sediment Release Experiments

Results of Sediment Benthic Nutrient Release Rate Studies at Marco Island Sites

| Site | Redox Condition | Date Collected | Time (days) | NH3 (µg/L) | NOx (µg/L) | Organic N (µg/L) | Total N (µg/L) | SRP (µg/L) | Organic P (µg/L) | Total P (µg/L) | Volume (L) | Total N (µg) | SRP (µg) | Total P (µg) | |
|------|-----------------|--------------------------------|-------------|------------|------------|------------------------------|----------------|------------|------------------|----------------|------------|--------------|----------|--------------|--|
| | | Starting water level (inches): | | 24.00 | | Ending water level (inches): | | 21.75 | | | | | | | |
| S-3 | Aerobic | 6/5/20 | 0 | 43 | 2 | 472 | 517 | 69 | 26 | 95 | 4.84 | 2,503 | 334 | 460 | |
| S-3 | | 6/8/20 | 3 | 225 | 15 | 493 | 733 | 62 | 26 | 88 | 4.81 | 3,523 | 298 | 423 | |
| S-3 | | 6/10/20 | 5 | 253 | 33 | 515 | 801 | 64 | 27 | 91 | 4.78 | 3,832 | 306 | 435 | |
| S-3 | | 6/12/20 | 7 | 261 | 71 | 503 | 835 | 88 | 27 | 115 | 4.76 | 3,976 | 419 | 548 | |
| S-3 | | 6/15/20 | 10 | 276 | 324 | 505 | 1,105 | 105 | 24 | 129 | 4.73 | 5,223 | 496 | 610 | |
| S-3 | | 6/19/20 | 14 | 211 | 337 | 570 | 1,118 | 133 | 27 | 160 | 4.68 | 5,234 | 623 | 749 | |
| S-3 | | 6/22/20 | 17 | 131 | 491 | 638 | 1,260 | 150 | 26 | 176 | 4.65 | 5,856 | 697 | 818 | |
| S-3 | | 6/24/20 | 19 | 36 | 542 | 690 | 1,268 | 179 | 26 | 205 | 4.62 | 5,864 | 828 | 948 | |
| S-3 | | 6/27/20 | 22 | 17 | 595 | 738 | 1,350 | 223 | 28 | 251 | 4.59 | 6,198 | 1,024 | 1,152 | |
| S-3 | | 7/1/20 | 26 | 3 | 611 | 816 | 1,430 | 242 | 26 | 268 | 4.55 | 6,500 | 1,100 | 1,218 | |
| S-3 | | 7/6/20 | 31 | 3 | 687 | 840 | 1,530 | 283 | 25 | 308 | 4.49 | 6,868 | 1,270 | 1,383 | |
| S-3 | | 7/8/20 | 33 | 3 | 717 | 844 | 1,564 | 289 | 28 | 317 | 4.47 | 6,985 | 1,291 | 1,416 | |
| S-3 | | 7/10/20 | 35 | 3 | 662 | 888 | 1,553 | 317 | 26 | 343 | 4.44 | 6,901 | 1,409 | 1,524 | |
| S-3 | | 7/13/20 | 38 | 3 | 647 | 846 | 1,496 | 338 | 25 | 363 | 4.41 | 6,597 | 1,490 | 1,601 | |
| S-3 | | 7/15/20 | 40 | 3 | 657 | 847 | 1,507 | 363 | 36 | 399 | 4.39 | 6,611 | 1,592 | 1,750 | |
| | | Starting water level (inches): | | 24.00 | | Ending water level (inches): | | 22.50 | | | | | | | |
| S-3 | Anoxic | 7/31/20 | 0 | 22 | 2 | 669 | 693 | 141 | 22 | 163 | 4.84 | 3,355 | 683 | 789 | |
| S-3 | | 8/3/20 | 3 | 238 | 2 | 653 | 893 | 101 | 21 | 122 | 4.82 | 4,303 | 487 | 588 | |
| S-3 | | 8/5/20 | 5 | 506 | 2 | 648 | 1,156 | 92 | 22 | 114 | 4.80 | 5,554 | 442 | 548 | |
| S-3 | | 8/7/20 | 7 | 531 | 2 | 718 | 1,251 | 109 | 25 | 134 | 4.79 | 5,992 | 522 | 642 | |
| S-3 | | 8/10/20 | 10 | 570 | 2 | 729 | 1,301 | 139 | 27 | 166 | 4.77 | 6,204 | 663 | 792 | |
| S-3 | | 8/13/20 | 13 | 633 | 2 | 734 | 1,369 | 195 | 23 | 218 | 4.75 | 6,499 | 926 | 1,035 | |
| S-3 | | 8/15/20 | 15 | 698 | 2 | 846 | 1,546 | 256 | 25 | 281 | 4.73 | 7,316 | 1,212 | 1,330 | |
| S-3 | | 8/17/20 | 17 | 788 | 2 | 987 | 1,777 | 316 | 31 | 347 | 4.72 | 8,384 | 1,491 | 1,637 | |
| S-3 | | 8/19/20 | 19 | 947 | 2 | 989 | 1,938 | 333 | 25 | 358 | 4.70 | 9,116 | 1,566 | 1,684 | |
| S-3 | | 8/21/20 | 21 | 1,010 | 2 | 984 | 1,996 | 338 | 20 | 358 | 4.69 | 9,360 | 1,585 | 1,679 | |
| S-3 | | 8/25/20 | 25 | 1,029 | 2 | 1,015 | 2,046 | 356 | 21 | 377 | 4.66 | 9,535 | 1,659 | 1,757 | |
| S-3 | | 8/26/20 | 26 | 1,063 | 2 | 1,042 | 2,107 | 417 | 25 | 442 | 4.65 | 9,804 | 1,940 | 2,057 | |
| S-3 | | 9/2/20 | 33 | 1,178 | 2 | 1,087 | 2,267 | 430 | 29 | 459 | 4.60 | 10,435 | 1,979 | 2,113 | |
| S-3 | | 9/4/20 | 35 | 1,296 | 2 | 1,018 | 2,316 | 504 | 29 | 533 | 4.59 | 10,627 | 2,313 | 2,446 | |
| S-3 | | 9/9/20 | 40 | 1,397 | 2 | 1,054 | 2,453 | 666 | 25 | 691 | 4.55 | 11,167 | 3,032 | 3,146 | |
| S-3 | | 9/11/20 | 42 | 1,375 | 2 | 1,003 | 2,380 | 731 | 26 | 757 | 4.54 | 10,800 | 3,317 | 3,435 | |

Results of Sediment Benthic Nutrient Release Rate Studies at Marco Island Sites

| Site | Redox Condition | Date Collected | Time (days) | NH3 (µg/L) | NOx (µg/L) | Organic N (µg/L) | Total N (µg/L) | SRP (µg/L) | Organic P (µg/L) | Total P (µg/L) | Volume (L) | Total N (µg) | SRP (µg) | Total P (µg) |
|--------------------------------|-----------------|----------------|-------------|------------|------------|------------------|----------------|------------|------------------|----------------|------------|--------------|----------|--------------|
| Starting water level (inches): | | | | 24.00 | | | | | | | | | | |
| Ending water level (inches): | | | | 22.00 | | | | | | | | | | |
| S-4 | Aerobic | 6/5/20 | 0 | 58 | 2 | 476 | 536 | 74 | 26 | 100 | 4.84 | 2,595 | 358 | 484 |
| S-4 | | 6/8/20 | 3 | 304 | 2 | 505 | 811 | 80 | 24 | 104 | 4.81 | 3,901 | 385 | 500 |
| S-4 | | 6/10/20 | 5 | 483 | 21 | 495 | 999 | 85 | 26 | 111 | 4.79 | 4,785 | 407 | 532 |
| S-4 | | 6/12/20 | 7 | 548 | 125 | 502 | 1,175 | 102 | 26 | 128 | 4.77 | 5,605 | 487 | 611 |
| S-4 | | 6/15/20 | 10 | 711 | 268 | 523 | 1,502 | 116 | 26 | 142 | 4.74 | 7,119 | 550 | 673 |
| S-4 | | 6/19/20 | 14 | 345 | 680 | 585 | 1,610 | 129 | 27 | 156 | 4.70 | 7,566 | 606 | 733 |
| S-4 | | 6/22/20 | 17 | 152 | 910 | 606 | 1,668 | 151 | 28 | 179 | 4.67 | 7,788 | 705 | 836 |
| S-4 | | 6/24/20 | 19 | 20 | 1,094 | 590 | 1,704 | 159 | 22 | 181 | 4.65 | 7,922 | 739 | 841 |
| S-4 | | 6/27/20 | 22 | 16 | 1,129 | 583 | 1,728 | 161 | 33 | 194 | 4.62 | 7,981 | 744 | 896 |
| S-4 | | 7/1/20 | 26 | 3 | 1,344 | 595 | 1,942 | 173 | 36 | 209 | 4.58 | 8,891 | 792 | 957 |
| S-4 | | 7/6/20 | 31 | 3 | 947 | 638 | 1,588 | 178 | 41 | 219 | 4.53 | 7,190 | 806 | 992 |
| S-4 | | 7/8/20 | 33 | 3 | 720 | 681 | 1,404 | 216 | 31 | 247 | 4.51 | 6,329 | 974 | 1,113 |
| S-4 | | 7/10/20 | 35 | 3 | 728 | 697 | 1,428 | 247 | 41 | 288 | 4.49 | 6,408 | 1,108 | 1,292 |
| S-4 | | 7/13/20 | 38 | 3 | 729 | 691 | 1,423 | 259 | 46 | 305 | 4.46 | 6,343 | 1,154 | 1,359 |
| S-4 | | 7/15/20 | 40 | 3 | 749 | 636 | 1,388 | 265 | 49 | 314 | 4.44 | 6,159 | 1,176 | 1,393 |
| Starting water level (inches): | | | | 24.00 | | | | | | | | | | |
| Ending water level (inches): | | | | 22.50 | | | | | | | | | | |
| S-4 | Anoxic | 7/31/20 | 0 | 16 | 2 | 643 | 661 | 127 | 26 | 153 | 4.84 | 3,200 | 615 | 741 |
| S-4 | | 8/3/20 | 3 | 119 | 2 | 808 | 929 | 122 | 25 | 147 | 4.82 | 4,477 | 588 | 708 |
| S-4 | | 8/5/20 | 5 | 121 | 2 | 796 | 919 | 112 | 26 | 138 | 4.80 | 4,415 | 538 | 663 |
| S-4 | | 8/7/20 | 7 | 184 | 2 | 824 | 1,010 | 171 | 25 | 196 | 4.79 | 4,838 | 819 | 939 |
| S-4 | | 8/10/20 | 10 | 232 | 2 | 817 | 1,051 | 229 | 27 | 256 | 4.77 | 5,012 | 1,092 | 1,221 |
| S-4 | | 8/13/20 | 13 | 268 | 2 | 867 | 1,137 | 249 | 33 | 282 | 4.75 | 5,397 | 1,182 | 1,339 |
| S-4 | | 8/15/20 | 15 | 286 | 2 | 885 | 1,173 | 286 | 32 | 318 | 4.73 | 5,551 | 1,353 | 1,505 |
| S-4 | | 8/17/20 | 17 | 369 | 2 | 907 | 1,278 | 318 | 40 | 358 | 4.72 | 6,030 | 1,500 | 1,689 |
| S-4 | | 8/19/20 | 19 | 463 | 2 | 937 | 1,402 | 326 | 35 | 361 | 4.70 | 6,595 | 1,533 | 1,698 |
| S-4 | | 8/21/20 | 21 | 537 | 2 | 965 | 1,504 | 368 | 35 | 403 | 4.69 | 7,053 | 1,726 | 1,890 |
| S-4 | | 8/25/20 | 25 | 666 | 2 | 915 | 1,583 | 401 | 35 | 436 | 4.66 | 7,378 | 1,869 | 2,032 |
| S-4 | | 8/26/20 | 26 | 724 | 2 | 843 | 1,569 | 421 | 40 | 461 | 4.65 | 7,301 | 1,959 | 2,145 |
| S-4 | | 9/2/20 | 33 | 938 | 2 | 847 | 1,787 | 438 | 38 | 476 | 4.60 | 8,225 | 2,016 | 2,191 |
| S-4 | | 9/4/20 | 35 | 1,072 | 2 | 890 | 1,964 | 461 | 39 | 500 | 4.59 | 9,012 | 2,115 | 2,294 |
| S-4 | | 9/9/20 | 40 | 1,111 | 2 | 837 | 1,950 | 483 | 37 | 520 | 4.55 | 8,877 | 2,199 | 2,367 |
| S-4 | 9/11/20 | 42 | 1,302 | 2 | 806 | 2,110 | 513 | 34 | 547 | 4.54 | 9,575 | 2,328 | 2,482 | |

Results of Sediment Benthic Nutrient Release Rate Studies at Marco Island Sites

| Site | Redox Condition | Date Collected | Time (days) | NH3 (µg/L) | NOx (µg/L) | Organic N (µg/L) | Total N (µg/L) | SRP (µg/L) | Organic P (µg/L) | Total P (µg/L) | Volume (L) | Total N (µg) | SRP (µg) | Total P (µg) |
|--------------------------------|-----------------|----------------|-------------|------------|------------|------------------|----------------|------------|------------------|----------------|------------|--------------|----------|--------------|
| Starting water level (inches): | | | | 24.00 | | | | | | | | | | |
| Ending water level (inches): | | | | 22.00 | | | | | | | | | | |
| S-5 | Aerobic | 6/5/20 | 0 | 33 | 2 | 445 | 480 | 70 | 23 | 93 | 4.84 | 2,323 | 339 | 450 |
| S-5 | | 6/8/20 | 3 | 82 | 2 | 473 | 557 | 75 | 23 | 98 | 4.81 | 2,679 | 361 | 471 |
| S-5 | | 6/10/20 | 5 | 103 | 2 | 510 | 615 | 70 | 37 | 107 | 4.79 | 2,946 | 335 | 513 |
| S-5 | | 6/12/20 | 7 | 213 | 13 | 512 | 738 | 62 | 34 | 96 | 4.77 | 3,520 | 296 | 458 |
| S-5 | | 6/15/20 | 10 | 242 | 70 | 633 | 945 | 84 | 33 | 117 | 4.74 | 4,479 | 398 | 555 |
| S-5 | | 6/19/20 | 14 | 314 | 131 | 639 | 1,084 | 95 | 34 | 129 | 4.70 | 5,094 | 446 | 606 |
| S-5 | | 6/22/20 | 17 | 252 | 257 | 597 | 1,106 | 115 | 36 | 151 | 4.67 | 5,164 | 537 | 705 |
| S-5 | | 6/24/20 | 19 | 156 | 320 | 665 | 1,141 | 142 | 36 | 178 | 4.65 | 5,304 | 660 | 828 |
| S-5 | | 6/27/20 | 22 | 128 | 389 | 656 | 1,173 | 181 | 22 | 203 | 4.62 | 5,418 | 836 | 938 |
| S-5 | | 7/1/20 | 26 | 3 | 449 | 736 | 1,188 | 210 | 24 | 234 | 4.58 | 5,439 | 961 | 1,071 |
| S-5 | | 7/16/20 | 31 | 3 | 451 | 744 | 1,198 | 218 | 23 | 241 | 4.53 | 5,424 | 987 | 1,091 |
| S-5 | | 7/18/20 | 33 | 3 | 481 | 728 | 1,212 | 369 | 30 | 399 | 4.51 | 5,463 | 1,663 | 1,799 |
| S-5 | | 7/10/20 | 35 | 3 | 471 | 824 | 1,298 | 357 | 35 | 392 | 4.49 | 5,825 | 1,602 | 1,759 |
| S-5 | | 7/13/20 | 38 | 3 | 473 | 808 | 1,284 | 334 | 32 | 366 | 4.46 | 5,723 | 1,489 | 1,631 |
| S-5 | 7/15/20 | 40 | 3 | 475 | 825 | 1,303 | 329 | 28 | 357 | 4.44 | 5,782 | 1,460 | 1,584 | |
| Starting water level (inches): | | | | 24.00 | | | | | | | | | | |
| Ending water level (inches): | | | | 21.75 | | | | | | | | | | |
| S-5 | Anoxic | 7/31/20 | 0 | 3 | 2 | 634 | 639 | 58 | 20 | 78 | 4.84 | 3,093 | 281 | 378 |
| S-5 | | 8/3/20 | 3 | 172 | 2 | 697 | 871 | 71 | 18 | 89 | 4.81 | 4,188 | 341 | 428 |
| S-5 | | 8/5/20 | 5 | 291 | 2 | 724 | 1,017 | 86 | 18 | 104 | 4.79 | 4,868 | 412 | 498 |
| S-5 | | 8/7/20 | 7 | 345 | 2 | 770 | 1,117 | 107 | 20 | 127 | 4.76 | 5,322 | 510 | 605 |
| S-5 | | 8/10/20 | 10 | 372 | 2 | 830 | 1,204 | 153 | 21 | 174 | 4.73 | 5,698 | 724 | 823 |
| S-5 | | 8/13/20 | 13 | 385 | 2 | 848 | 1,235 | 166 | 23 | 189 | 4.70 | 5,805 | 780 | 888 |
| S-5 | | 8/15/20 | 15 | 405 | 2 | 872 | 1,279 | 212 | 25 | 237 | 4.68 | 5,984 | 992 | 1,109 |
| S-5 | | 8/17/20 | 17 | 495 | 2 | 875 | 1,372 | 217 | 24 | 241 | 4.66 | 6,389 | 1,011 | 1,122 |
| S-5 | | 8/19/20 | 19 | 683 | 2 | 802 | 1,487 | 233 | 20 | 253 | 4.64 | 6,893 | 1,080 | 1,173 |
| S-5 | | 8/21/20 | 21 | 709 | 2 | 807 | 1,518 | 238 | 24 | 262 | 4.61 | 7,004 | 1,098 | 1,209 |
| S-5 | | 8/25/20 | 25 | 739 | 2 | 788 | 1,529 | 228 | 24 | 252 | 4.57 | 6,988 | 1,042 | 1,152 |
| S-5 | | 8/26/20 | 26 | 883 | 2 | 777 | 1,662 | 236 | 27 | 263 | 4.56 | 7,578 | 1,076 | 1,199 |
| S-5 | | 9/2/20 | 33 | 897 | 2 | 778 | 1,677 | 258 | 23 | 281 | 4.48 | 7,520 | 1,157 | 1,260 |
| S-5 | | 9/4/20 | 35 | 960 | 2 | 748 | 1,710 | 274 | 25 | 299 | 4.46 | 7,631 | 1,223 | 1,334 |
| S-5 | 9/9/20 | 40 | 1,072 | 2 | 728 | 1,802 | 296 | 28 | 324 | 4.41 | 7,944 | 1,305 | 1,428 | |
| S-5 | 9/11/20 | 42 | 1,107 | 2 | 749 | 1,858 | 327 | 28 | 355 | 4.39 | 8,151 | 1,434 | 1,557 | |

Results of Sediment Benthic Nutrient Release Rate Studies at Marco Island Sites

| Site | Redox Condition | Date Collected | Time (days) | NH3 (µg/L) | NOx (µg/L) | Organic N (µg/L) | Total N (µg/L) | SRP (µg/L) | Organic P (µg/L) | Total P (µg/L) | Volume (L) | Total N (µg) | SRP (µg) | Total P (µg) | |
|------|-----------------|----------------|-------------|------------------------------|------------|------------------|----------------|------------|------------------|----------------|------------|--------------|----------|--------------|--|
| | | 24.00 | | Ending water level (inches): | | 20.75 | | | | | | | | | |
| S-9 | Aerobic | 6/5/20 | 0 | 44 | 2 | 485 | 531 | 76 | 17 | 93 | 4.84 | 2,570 | 368 | 450 | |
| S-9 | | 6/8/20 | 3 | 135 | 2 | 420 | 557 | 89 | 22 | 111 | 4.79 | 2,669 | 426 | 532 | |
| S-9 | | 6/10/20 | 5 | 183 | 13 | 507 | 703 | 95 | 21 | 116 | 4.76 | 3,345 | 452 | 552 | |
| S-9 | | 6/12/20 | 7 | 215 | 19 | 550 | 784 | 107 | 23 | 130 | 4.73 | 3,705 | 506 | 614 | |
| S-9 | | 6/15/20 | 10 | 334 | 80 | 550 | 964 | 118 | 30 | 148 | 4.68 | 4,508 | 552 | 692 | |
| S-9 | | 6/19/20 | 14 | 303 | 142 | 623 | 1,068 | 134 | 30 | 164 | 4.61 | 4,925 | 618 | 756 | |
| S-9 | | 6/22/20 | 17 | 259 | 205 | 684 | 1,148 | 183 | 23 | 206 | 4.56 | 5,237 | 835 | 940 | |
| S-9 | | 6/24/20 | 19 | 217 | 251 | 765 | 1,233 | 207 | 27 | 234 | 4.53 | 5,584 | 938 | 1,060 | |
| S-9 | | 6/27/20 | 22 | 81 | 277 | 721 | 1,079 | 229 | 32 | 261 | 4.48 | 4,834 | 1,026 | 1,169 | |
| S-9 | | 7/1/20 | 26 | 3 | 316 | 788 | 1,107 | 242 | 30 | 272 | 4.41 | 4,887 | 1,068 | 1,201 | |
| S-9 | | 7/6/20 | 31 | 3 | 324 | 811 | 1,138 | 304 | 33 | 337 | 4.33 | 4,930 | 1,317 | 1,460 | |
| S-9 | | 7/8/20 | 33 | 3 | 475 | 852 | 1,330 | 389 | 33 | 422 | 4.30 | 5,719 | 1,673 | 1,815 | |
| S-9 | | 7/10/20 | 35 | 3 | 502 | 805 | 1,310 | 429 | 44 | 473 | 4.27 | 5,590 | 1,831 | 2,018 | |
| S-9 | | 7/13/20 | 38 | 3 | 477 | 832 | 1,312 | 474 | 39 | 513 | 4.22 | 5,534 | 1,999 | 2,164 | |
| S-9 | | 7/15/20 | 40 | 3 | 496 | 810 | 1,309 | 430 | 41 | 471 | 4.19 | 5,478 | 1,800 | 1,971 | |
| | | 24.00 | | Ending water level (inches): | | 21.75 | | | | | | | | | |
| S-9 | Anoxic | 7/31/20 | 0 | 20 | 2 | 629 | 651 | 116 | 22 | 138 | 4.84 | 3,151 | 562 | 668 | |
| S-9 | | 8/3/20 | 3 | 186 | 2 | 636 | 824 | 108 | 15 | 123 | 4.81 | 3,962 | 519 | 591 | |
| S-9 | | 8/5/20 | 5 | 208 | 2 | 769 | 979 | 88 | 16 | 104 | 4.79 | 4,686 | 421 | 498 | |
| S-9 | | 8/7/20 | 7 | 258 | 2 | 765 | 1,025 | 87 | 20 | 107 | 4.76 | 4,884 | 415 | 510 | |
| S-9 | | 8/10/20 | 10 | 285 | 2 | 762 | 1,049 | 114 | 19 | 133 | 4.73 | 4,964 | 540 | 629 | |
| S-9 | | 8/13/20 | 13 | 234 | 2 | 842 | 1,078 | 163 | 21 | 184 | 4.70 | 5,067 | 766 | 865 | |
| S-9 | | 8/15/20 | 15 | 322 | 2 | 861 | 1,185 | 180 | 26 | 206 | 4.68 | 5,544 | 842 | 964 | |
| S-9 | | 8/17/20 | 17 | 330 | 2 | 783 | 1,115 | 228 | 25 | 253 | 4.66 | 5,192 | 1,062 | 1,178 | |
| S-9 | | 8/19/20 | 19 | 376 | 2 | 785 | 1,163 | 247 | 25 | 272 | 4.64 | 5,391 | 1,145 | 1,261 | |
| S-9 | | 8/21/20 | 21 | 415 | 2 | 793 | 1,210 | 268 | 31 | 299 | 4.61 | 5,583 | 1,236 | 1,379 | |
| S-9 | | 8/25/20 | 25 | 523 | 2 | 788 | 1,313 | 281 | 34 | 315 | 4.57 | 6,001 | 1,284 | 1,440 | |
| S-9 | | 8/26/20 | 26 | 592 | 2 | 770 | 1,364 | 283 | 41 | 324 | 4.56 | 6,219 | 1,290 | 1,477 | |
| S-9 | 9/2/20 | 33 | 603 | 2 | 767 | 1,372 | 252 | 77 | 329 | 4.48 | 6,152 | 1,130 | 1,475 | | |
| S-9 | 9/4/20 | 35 | 633 | 2 | 770 | 1,405 | 308 | 37 | 345 | 4.46 | 6,270 | 1,374 | 1,540 | | |
| S-9 | 9/9/20 | 40 | 708 | 2 | 713 | 1,423 | 422 | 51 | 473 | 4.41 | 6,273 | 1,860 | 2,085 | | |
| S-9 | 9/11/20 | 42 | 725 | 2 | 730 | 1,457 | 451 | 58 | 509 | 4.39 | 6,391 | 1,978 | 2,233 | | |

Results of Sediment Benthic Nutrient Release Rate Studies at Marco Island Sites

| Site | Redox Condition | Date Collected | Time (days) | NH3 (µg/L) | NOx (µg/L) | Organic N (µg/L) | Total N (µg/L) | SRP (µg/L) | Organic P (µg/L) | Total P (µg/L) | Volume (L) | Total N (µg) | SRP (µg) | Total P (µg) |
|--------------------------------|-----------------|----------------|-------------|------------------------------|------------|------------------|----------------|------------|------------------|----------------|------------|--------------|----------|--------------|
| Starting water level (inches): | | | | Ending water level (inches): | | | | | | | | | | |
| 24.00 | | | | 21.50 | | | | | | | | | | |
| S-10 | Aerobic | 7/31/20 | 0 | 26 | 2 | 696 | 724 | 37 | 14 | 51 | 4.84 | 3,505 | 179 | 247 |
| S-10 | | 8/3/20 | 3 | 99 | 2 | 586 | 687 | 34 | 19 | 53 | 4.80 | 3,301 | 163 | 255 |
| S-10 | | 8/5/20 | 5 | 164 | 2 | 550 | 716 | 38 | 17 | 55 | 4.78 | 3,423 | 182 | 263 |
| S-10 | | 8/7/20 | 7 | 277 | 2 | 587 | 866 | 40 | 26 | 66 | 4.76 | 4,119 | 190 | 314 |
| S-10 | | 8/10/20 | 10 | 510 | 2 | 643 | 1,155 | 71 | 26 | 97 | 4.72 | 5,452 | 335 | 458 |
| S-10 | | 8/13/20 | 13 | 562 | 2 | 804 | 1,368 | 74 | 29 | 103 | 4.68 | 6,408 | 347 | 483 |
| S-10 | | 8/15/20 | 15 | 623 | 2 | 858 | 1,483 | 76 | 38 | 114 | 4.66 | 6,911 | 354 | 531 |
| S-10 | | 8/17/20 | 17 | 786 | 2 | 1,015 | 1,803 | 82 | 38 | 120 | 4.64 | 8,360 | 380 | 556 |
| S-10 | | 8/19/20 | 19 | 404 | 78 | 1,434 | 1,916 | 89 | 33 | 122 | 4.61 | 8,837 | 411 | 563 |
| S-10 | | 8/21/20 | 21 | 335 | 181 | 1,760 | 2,276 | 92 | 34 | 126 | 4.59 | 10,443 | 422 | 578 |
| S-10 | | 8/25/20 | 25 | 208 | 638 | 1,336 | 2,182 | 100 | 36 | 136 | 4.54 | 9,907 | 454 | 617 |
| S-10 | | 8/26/20 | 26 | 3 | 1,362 | 532 | 1,897 | 111 | 33 | 144 | 4.53 | 8,590 | 503 | 652 |
| S-10 | | 9/2/20 | 33 | 3 | 1,254 | 456 | 1,713 | 114 | 38 | 152 | 4.44 | 7,613 | 507 | 676 |
| S-10 | | 9/4/20 | 35 | 3 | 1,242 | 371 | 1,616 | 138 | 40 | 178 | 4.42 | 7,143 | 610 | 787 |
| S-10 | 9/9/20 | 40 | 3 | 1,066 | 309 | 1,378 | 198 | 38 | 236 | 4.36 | 6,009 | 863 | 1,029 | |
| S-10 | 9/11/20 | 42 | 3 | 1,041 | 182 | 1,226 | 110 | 44 | 154 | 4.34 | 5,316 | 477 | 668 | |
| Starting water level (inches): | | | | Ending water level (inches): | | | | | | | | | | |
| 24.00 | | | | 22.25 | | | | | | | | | | |
| S-10 | Anoxic | 9/25/20 | 0 | 3 | 2 | 453 | 458 | 76 | 18 | 94 | 4.84 | 2,217 | 368 | 455 |
| S-10 | | 9/28/20 | 3 | 3 | 2 | 425 | 430 | 86 | 18 | 104 | 4.81 | 2,067 | 413 | 500 |
| S-10 | | 10/2/20 | 7 | 143 | 2 | 450 | 595 | 90 | 19 | 109 | 4.76 | 2,833 | 428 | 519 |
| S-10 | | 10/5/20 | 10 | 347 | 2 | 445 | 794 | 93 | 22 | 115 | 4.73 | 3,753 | 440 | 544 |
| S-10 | | 10/7/20 | 12 | 468 | 2 | 436 | 906 | 97 | 25 | 122 | 4.70 | 4,262 | 456 | 574 |
| S-10 | | 10/9/20 | 14 | 500 | 2 | 547 | 1,049 | 101 | 25 | 126 | 4.68 | 4,911 | 473 | 590 |
| S-10 | | 10/12/20 | 17 | 548 | 2 | 621 | 1,171 | 121 | 23 | 144 | 4.65 | 5,442 | 562 | 669 |
| S-10 | | 10/14/20 | 19 | 726 | 2 | 622 | 1,350 | 135 | 23 | 158 | 4.62 | 6,243 | 624 | 731 |
| S-10 | | 10/16/20 | 21 | 930 | 2 | 502 | 1,434 | 142 | 27 | 169 | 4.60 | 6,598 | 653 | 778 |
| S-10 | | 10/19/20 | 24 | 1,172 | 2 | 339 | 1,513 | 159 | 25 | 184 | 4.57 | 6,910 | 726 | 840 |
| S-10 | | 10/21/20 | 26 | 1,045 | 2 | 378 | 1,425 | 161 | 23 | 184 | 4.54 | 6,476 | 732 | 836 |
| S-10 | | 10/23/20 | 28 | 1,010 | 2 | 370 | 1,382 | 168 | 27 | 195 | 4.52 | 6,249 | 760 | 882 |
| S-10 | | 10/26/20 | 31 | 969 | 2 | 318 | 1,289 | 171 | 35 | 206 | 4.49 | 5,785 | 767 | 924 |

Results of Sediment Benthic Nutrient Release Rate Studies at Marco Island Sites

| Site | Redox Condition | Date Collected | Time (days) | NH3 (µg/L) | NOx (µg/L) | Organic N (µg/L) | Total N (µg/L) | SRP (µg/L) | Organic P (µg/L) | Total P (µg/L) | Volume (L) | Total N (µg) | SRP (µg) | Total P (µg) |
|--------------------------------|-----------------|----------------|-------------|------------|------------|------------------|----------------|------------|------------------|----------------|------------|--------------|----------|--------------|
| Starting water level (inches): | | | | 24.00 | | | | | | | | | | |
| Ending water level (inches): | | | | 20.25 | | | | | | | | | | |
| S-15 | Aerobic | 7/31/20 | 0 | 27 | 2 | 689 | 718 | 56 | 12 | 68 | 4.84 | 3,476 | 271 | 329 |
| S-15 | | 8/3/20 | 3 | 135 | 2 | 717 | 854 | 62 | 13 | 75 | 4.79 | 4,088 | 297 | 359 |
| S-15 | | 8/5/20 | 5 | 175 | 2 | 724 | 901 | 47 | 14 | 61 | 4.75 | 4,280 | 223 | 290 |
| S-15 | | 8/7/20 | 7 | 180 | 2 | 789 | 971 | 52 | 14 | 66 | 4.71 | 4,578 | 245 | 311 |
| S-15 | | 8/10/20 | 10 | 478 | 38 | 746 | 1,262 | 57 | 15 | 72 | 4.66 | 5,882 | 266 | 336 |
| S-15 | | 8/13/20 | 13 | 178 | 127 | 1,066 | 1,371 | 61 | 16 | 77 | 4.61 | 6,315 | 281 | 355 |
| S-15 | | 8/15/20 | 15 | 90 | 361 | 1,107 | 1,558 | 65 | 16 | 81 | 4.57 | 7,121 | 297 | 370 |
| S-15 | | 8/17/20 | 17 | 3 | 410 | 1,212 | 1,625 | 69 | 18 | 87 | 4.53 | 7,368 | 313 | 394 |
| S-15 | | 8/19/20 | 19 | 3 | 516 | 1,181 | 1,700 | 75 | 17 | 92 | 4.50 | 7,647 | 337 | 414 |
| S-15 | | 8/21/20 | 21 | 3 | 603 | 1,248 | 1,854 | 79 | 18 | 97 | 4.46 | 8,273 | 353 | 433 |
| S-15 | | 8/25/20 | 25 | 3 | 682 | 1,770 | 2,455 | 84 | 18 | 102 | 4.39 | 10,778 | 369 | 448 |
| S-15 | | 8/26/20 | 26 | 3 | 678 | 1,487 | 2,168 | 89 | 21 | 110 | 4.37 | 9,479 | 389 | 481 |
| S-15 | | 9/2/20 | 33 | 3 | 618 | 1,173 | 1,794 | 97 | 20 | 117 | 4.25 | 7,618 | 412 | 497 |
| S-15 | | 9/4/20 | 35 | 3 | 606 | 725 | 1,334 | 111 | 24 | 135 | 4.21 | 5,617 | 467 | 568 |
| S-15 | | 9/9/20 | 40 | 3 | 464 | 563 | 1,030 | 120 | 23 | 143 | 4.12 | 4,244 | 494 | 589 |
| S-15 | | 9/11/20 | 42 | 3 | 489 | 495 | 987 | 149 | 24 | 173 | 4.08 | 4,031 | 609 | 707 |
| Starting water level (inches): | | | | 24.00 | | | | | | | | | | |
| Ending water level (inches): | | | | 21.50 | | | | | | | | | | |
| S-15 | Anoxic | 9/25/20 | 0 | 3 | 2 | 478 | 483 | 49 | 28 | 77 | 4.84 | 2,338 | 237 | 373 |
| S-15 | | 9/28/20 | 3 | 3 | 2 | 482 | 487 | 67 | 29 | 96 | 4.79 | 2,334 | 321 | 460 |
| S-15 | | 10/2/20 | 7 | 52 | 2 | 472 | 526 | 97 | 29 | 126 | 4.73 | 2,486 | 458 | 596 |
| S-15 | | 10/5/20 | 10 | 152 | 2 | 474 | 628 | 121 | 28 | 149 | 4.68 | 2,938 | 566 | 697 |
| S-15 | | 10/7/20 | 12 | 328 | 2 | 504 | 834 | 151 | 27 | 178 | 4.65 | 3,874 | 701 | 827 |
| S-15 | | 10/9/20 | 14 | 400 | 2 | 551 | 953 | 266 | 24 | 290 | 4.61 | 4,396 | 1,227 | 1,338 |
| S-15 | | 10/12/20 | 17 | 538 | 2 | 574 | 1,114 | 322 | 36 | 358 | 4.56 | 5,084 | 1,470 | 1,634 |
| S-15 | | 10/14/20 | 19 | 1,154 | 2 | 508 | 1,664 | 428 | 37 | 465 | 4.53 | 7,540 | 1,939 | 2,107 |
| S-15 | | 10/16/20 | 21 | 1,278 | 2 | 537 | 1,817 | 317 | 41 | 358 | 4.50 | 8,175 | 1,426 | 1,611 |
| S-15 | | 10/19/20 | 24 | 1,415 | 2 | 515 | 1,932 | 236 | 42 | 278 | 4.45 | 8,598 | 1,050 | 1,237 |
| S-15 | | 10/21/20 | 26 | 1,253 | 2 | 536 | 1,791 | 216 | 45 | 261 | 4.42 | 7,912 | 954 | 1,153 |
| S-15 | | 10/23/20 | 28 | 1,039 | 2 | 472 | 1,513 | 188 | 41 | 229 | 4.39 | 6,635 | 824 | 1,004 |
| S-15 | | 10/26/20 | 31 | 1,007 | 2 | 424 | 1,433 | 153 | 42 | 195 | 4.34 | 6,214 | 663 | 846 |

Results of Sediment Benthic Nutrient Release Rate Studies at Marco Island Sites

| Site | Redox Condition | Date Collected | Time (days) | NH3 (µg/L) | NOx (µg/L) | Organic N (µg/L) | Total N (µg/L) | SRP (µg/L) | Organic P (µg/L) | Total P (µg/L) | Volume (L) | Total N (µg) | SRP (µg) | Total P (µg) |
|--------------------------------|-----------------|----------------|-------------|------------|------------|------------------|----------------|------------|------------------|----------------|------------|--------------|----------|--------------|
| Starting water level (inches): | | | | 24.00 | | | | | | | | | | |
| Ending water level (inches): | | | | 22.25 | | | | | | | | | | |
| S-16 | Aerobic | 7/31/20 | 0 | 133 | 2 | 633 | 768 | 38 | 16 | 54 | 4.84 | 3,718 | 184 | 261 |
| S-16 | | 8/3/20 | 3 | 125 | 2 | 606 | 733 | 43 | 18 | 61 | 4.82 | 3,530 | 207 | 294 |
| S-16 | | 8/5/20 | 5 | 61 | 26 | 630 | 717 | 48 | 18 | 66 | 4.80 | 3,441 | 230 | 317 |
| S-16 | | 8/7/20 | 7 | 22 | 60 | 669 | 751 | 54 | 14 | 68 | 4.78 | 3,591 | 258 | 325 |
| S-16 | | 8/10/20 | 10 | 9 | 135 | 692 | 836 | 63 | 19 | 82 | 4.76 | 3,976 | 300 | 390 |
| S-16 | | 8/13/20 | 13 | 3 | 217 | 669 | 889 | 68 | 18 | 86 | 4.73 | 4,206 | 322 | 407 |
| S-16 | | 8/15/20 | 15 | 3 | 241 | 647 | 891 | 71 | 19 | 90 | 4.71 | 4,201 | 335 | 424 |
| S-16 | | 8/17/20 | 17 | 3 | 292 | 693 | 988 | 79 | 20 | 99 | 4.70 | 4,641 | 371 | 465 |
| S-16 | | 8/19/20 | 19 | 3 | 313 | 731 | 1,047 | 84 | 19 | 103 | 4.68 | 4,901 | 393 | 482 |
| S-16 | | 8/21/20 | 21 | 3 | 395 | 787 | 1,185 | 94 | 20 | 114 | 4.66 | 5,527 | 438 | 532 |
| S-16 | | 8/25/20 | 25 | 3 | 469 | 742 | 1,214 | 101 | 21 | 122 | 4.63 | 5,621 | 468 | 565 |
| S-16 | | 8/26/20 | 26 | 3 | 488 | 762 | 1,253 | 107 | 22 | 129 | 4.62 | 5,791 | 495 | 596 |
| S-16 | | 9/2/20 | 33 | 3 | 538 | 745 | 1,286 | 119 | 21 | 140 | 4.56 | 5,868 | 543 | 639 |
| S-16 | | 9/4/20 | 35 | 3 | 622 | 769 | 1,394 | 120 | 27 | 147 | 4.55 | 6,338 | 546 | 668 |
| S-16 | | 9/9/20 | 40 | 3 | 622 | 812 | 1,437 | 126 | 26 | 152 | 4.50 | 6,473 | 568 | 685 |
| S-16 | | 9/11/20 | 42 | 3 | 608 | 783 | 1,394 | 133 | 29 | 162 | 4.49 | 6,256 | 597 | 727 |
| Starting water level (inches): | | | | 24.00 | | | | | | | | | | |
| Ending water level (inches): | | | | 21.75 | | | | | | | | | | |
| S-16 | Anoxic | 9/25/20 | 0 | 3 | 2 | 458 | 463 | 56 | 14 | 70 | 4.84 | 2,241 | 271 | 339 |
| S-16 | | 9/28/20 | 3 | 3 | 2 | 524 | 529 | 86 | 9 | 95 | 4.80 | 2,537 | 413 | 456 |
| S-16 | | 10/2/20 | 7 | 137 | 2 | 454 | 593 | 99 | 9 | 108 | 4.74 | 2,810 | 469 | 512 |
| S-16 | | 10/5/20 | 10 | 169 | 2 | 500 | 671 | 105 | 13 | 118 | 4.69 | 3,150 | 493 | 554 |
| S-16 | | 10/7/20 | 12 | 239 | 2 | 520 | 761 | 106 | 14 | 120 | 4.66 | 3,550 | 494 | 560 |
| S-16 | | 10/9/20 | 14 | 301 | 2 | 536 | 839 | 192 | 17 | 209 | 4.64 | 3,889 | 890 | 969 |
| S-16 | | 10/12/20 | 17 | 369 | 2 | 543 | 914 | 210 | 18 | 228 | 4.59 | 4,197 | 964 | 1,047 |
| S-16 | | 10/14/20 | 19 | 487 | 2 | 578 | 1,067 | 314 | 24 | 338 | 4.56 | 4,868 | 1,433 | 1,542 |
| S-16 | | 10/16/20 | 21 | 577 | 2 | 595 | 1,174 | 285 | 26 | 311 | 4.53 | 5,322 | 1,292 | 1,410 |
| S-16 | | 10/19/20 | 24 | 712 | 2 | 668 | 1,382 | 264 | 27 | 291 | 4.49 | 6,204 | 1,185 | 1,306 |
| S-16 | | 10/21/20 | 26 | 548 | 2 | 682 | 1,232 | 249 | 28 | 277 | 4.46 | 5,495 | 1,111 | 1,235 |
| S-16 | | 10/23/20 | 28 | 611 | 2 | 648 | 1,261 | 229 | 24 | 253 | 4.43 | 5,587 | 1,015 | 1,121 |
| S-16 | | 10/26/20 | 31 | 668 | 2 | 676 | 1,346 | 200 | 28 | 228 | 4.39 | 5,905 | 877 | 1,000 |

Results of Sediment Benthic Nutrient Release Rate Studies at Marco Island Sites

| Site | Redox Condition | Date Collected | Time (days) | NH3 (µg/L) | NOx (µg/L) | Organic N (µg/L) | Total N (µg/L) | SRP (µg/L) | Organic P (µg/L) | Total P (µg/L) | Volume (L) | Total N (µg) | SRP (µg) | Total P (µg) | |
|--------------------------------|-----------------|----------------|-------------|------------|------------|------------------|----------------|------------------------------|------------------|----------------|------------|--------------|----------|--------------|--|
| Starting water level (inches): | | | | 24.00 | | | | Ending water level (inches): | | | | 21.75 | | | |
| S-22 | | 7/31/20 | 0 | 76 | 2 | 628 | 706 | 41 | 19 | 60 | 4.84 | 3,417 | 198 | 290 | |
| S-22 | | 8/3/20 | 3 | 129 | 2 | 621 | 752 | 48 | 20 | 68 | 4.81 | 3,616 | 231 | 327 | |
| S-22 | | 8/5/20 | 5 | 257 | 2 | 599 | 858 | 51 | 20 | 71 | 4.79 | 4,107 | 244 | 340 | |
| S-22 | | 8/7/20 | 7 | 385 | 2 | 553 | 940 | 56 | 22 | 78 | 4.76 | 4,479 | 267 | 372 | |
| S-22 | | 8/10/20 | 10 | 434 | 2 | 647 | 1,083 | 60 | 31 | 91 | 4.73 | 5,125 | 284 | 431 | |
| S-22 | | 8/13/20 | 13 | 364 | 2 | 747 | 1,113 | 70 | 30 | 100 | 4.70 | 5,231 | 329 | 470 | |
| S-22 | | 8/15/20 | 15 | 285 | 125 | 840 | 1,250 | 93 | 31 | 124 | 4.68 | 5,848 | 435 | 580 | |
| S-22 | | 8/17/20 | 17 | 187 | 136 | 960 | 1,283 | 107 | 32 | 139 | 4.66 | 5,975 | 498 | 647 | |
| S-22 | Aerobic | 8/19/20 | 19 | 37 | 231 | 1,046 | 1,314 | 113 | 32 | 145 | 4.64 | 6,091 | 524 | 672 | |
| S-22 | | 8/21/20 | 21 | 3 | 295 | 1,068 | 1,366 | 123 | 31 | 154 | 4.61 | 6,302 | 567 | 711 | |
| S-22 | | 8/25/20 | 25 | 3 | 896 | 855 | 1,754 | 137 | 24 | 161 | 4.57 | 8,017 | 626 | 736 | |
| S-22 | | 8/26/20 | 26 | 3 | 947 | 943 | 1,893 | 151 | 32 | 183 | 4.56 | 8,631 | 689 | 834 | |
| S-22 | | 9/2/20 | 33 | 3 | 1,120 | 994 | 2,117 | 158 | 34 | 192 | 4.48 | 9,493 | 708 | 861 | |
| S-22 | | 9/4/20 | 35 | 3 | 1,168 | 930 | 2,101 | 167 | 35 | 202 | 4.46 | 9,375 | 745 | 901 | |
| S-22 | | 9/9/20 | 40 | 3 | 1,356 | 900 | 2,259 | 186 | 38 | 224 | 4.41 | 9,958 | 820 | 987 | |
| S-22 | | 9/11/20 | 42 | 3 | 1,416 | 915 | 2,334 | 185 | 41 | 226 | 4.39 | 10,239 | 812 | 991 | |
| Starting water level (inches): | | | | 24.00 | | | | Ending water level (inches): | | | | 22.00 | | | |
| S-22 | | 9/25/20 | 0 | 3 | 2 | 508 | 513 | 44 | 14 | 58 | 4.84 | 2,483 | 213 | 281 | |
| S-22 | | 9/28/20 | 3 | 3 | 2 | 615 | 620 | 86 | 13 | 99 | 4.80 | 2,977 | 413 | 475 | |
| S-22 | | 10/2/20 | 7 | 171 | 2 | 566 | 739 | 98 | 14 | 112 | 4.75 | 3,510 | 465 | 532 | |
| S-22 | | 10/5/20 | 10 | 248 | 2 | 562 | 812 | 108 | 16 | 124 | 4.71 | 3,825 | 509 | 584 | |
| S-22 | | 10/7/20 | 12 | 427 | 2 | 588 | 1,017 | 122 | 17 | 139 | 4.68 | 4,764 | 571 | 651 | |
| S-22 | | 10/9/20 | 14 | 553 | 2 | 551 | 1,106 | 217 | 24 | 241 | 4.66 | 5,152 | 1,011 | 1,123 | |
| S-22 | Anoxic | 10/12/20 | 17 | 652 | 2 | 603 | 1,257 | 256 | 23 | 279 | 4.62 | 5,807 | 1,183 | 1,289 | |
| S-22 | | 10/14/20 | 19 | 947 | 2 | 562 | 1,511 | 291 | 26 | 317 | 4.59 | 6,941 | 1,337 | 1,456 | |
| S-22 | | 10/16/20 | 21 | 1,077 | 2 | 598 | 1,677 | 269 | 33 | 302 | 4.57 | 7,659 | 1,229 | 1,379 | |
| S-22 | | 10/19/20 | 24 | 1,082 | 2 | 542 | 1,626 | 241 | 32 | 273 | 4.53 | 7,363 | 1,091 | 1,236 | |
| S-22 | | 10/21/20 | 26 | 1,139 | 2 | 196 | 1,337 | 206 | 31 | 237 | 4.50 | 6,019 | 927 | 1,067 | |
| S-22 | | 10/23/20 | 28 | 1,122 | 2 | 314 | 1,438 | 143 | 32 | 175 | 4.48 | 6,437 | 640 | 783 | |
| S-22 | | 10/26/20 | 31 | 1,106 | 2 | 332 | 1,440 | 118 | 33 | 151 | 4.44 | 6,390 | 524 | 670 | |

Results of Sediment Benthic Nutrient Release Rate Studies at Marco Island Sites

| Site | Redox Condition | Date Collected | Time (days) | NH3 (µg/L) | NOx (µg/L) | Organic N (µg/L) | Total N (µg/L) | SRP (µg/L) | Organic P (µg/L) | Total P (µg/L) | Volume (L) | Total N (µg) | SRP (µg) | Total P (µg) |
|--------------------------------|-----------------|----------------|-------------|------------|------------|------------------|----------------|------------|------------------|----------------|------------|--------------|----------|--------------|
| Starting water level (inches): | | | | 24.00 | | | | | | | | | | |
| Ending water level (inches): | | | | 22.00 | | | | | | | | | | |
| S-23 | | 6/5/20 | 0 | 53 | 2 | 425 | 480 | 75 | 17 | 92 | 4.84 | 2,323 | 363 | 445 |
| S-23 | | 6/8/20 | 3 | 657 | 2 | 418 | 1,077 | 64 | 17 | 81 | 4.81 | 5,181 | 308 | 390 |
| S-23 | | 6/10/20 | 5 | 1,170 | 36 | 429 | 1,635 | 85 | 19 | 104 | 4.79 | 7,832 | 407 | 498 |
| S-23 | | 6/12/20 | 7 | 1,284 | 69 | 659 | 2,012 | 125 | 18 | 143 | 4.77 | 9,597 | 596 | 682 |
| S-23 | | 6/15/20 | 10 | 1,309 | 175 | 662 | 2,146 | 163 | 19 | 182 | 4.74 | 10,171 | 773 | 863 |
| S-23 | | 6/19/20 | 14 | 1,262 | 328 | 666 | 2,256 | 202 | 21 | 223 | 4.70 | 10,602 | 949 | 1,048 |
| S-23 | | 6/22/20 | 17 | 1,203 | 841 | 716 | 2,760 | 246 | 22 | 268 | 4.67 | 12,887 | 1,149 | 1,251 |
| S-23 | Aerobic | 6/24/20 | 19 | 870 | 1,345 | 722 | 2,937 | 290 | 21 | 311 | 4.65 | 13,654 | 1,348 | 1,446 |
| S-23 | | 6/27/20 | 22 | 424 | 2,043 | 828 | 3,295 | 321 | 28 | 349 | 4.62 | 15,219 | 1,483 | 1,612 |
| S-23 | | 7/1/20 | 26 | 21 | 2,232 | 902 | 3,155 | 349 | 24 | 373 | 4.58 | 14,445 | 1,598 | 1,708 |
| S-23 | | 7/6/20 | 31 | 3 | 2,312 | 970 | 3,285 | 442 | 22 | 464 | 4.53 | 14,874 | 2,001 | 2,101 |
| S-23 | | 7/8/20 | 33 | 3 | 2,351 | 926 | 3,280 | 536 | 30 | 566 | 4.51 | 14,785 | 2,416 | 2,551 |
| S-23 | | 7/10/20 | 35 | 3 | 2,404 | 995 | 3,402 | 597 | 25 | 622 | 4.49 | 15,267 | 2,679 | 2,791 |
| S-23 | | 7/13/20 | 38 | 3 | 2,585 | 929 | 3,517 | 645 | 29 | 674 | 4.46 | 15,676 | 2,875 | 3,004 |
| S-23 | | 7/15/20 | 40 | 3 | 2,756 | 979 | 3,738 | 624 | 22 | 646 | 4.44 | 16,586 | 2,769 | 2,866 |
| Starting water level (inches): | | | | 24.00 | | | | | | | | | | |
| Ending water level (inches): | | | | 21.75 | | | | | | | | | | |
| S-23 | | 7/31/20 | 0 | 3 | 9 | 780 | 792 | 104 | 20 | 124 | 4.84 | 3,834 | 503 | 600 |
| S-23 | | 8/3/20 | 3 | 519 | 2 | 768 | 1,289 | 200 | 21 | 221 | 4.81 | 6,198 | 962 | 1,063 |
| S-23 | | 8/5/20 | 5 | 940 | 2 | 751 | 1,693 | 264 | 22 | 286 | 4.79 | 8,104 | 1,264 | 1,369 |
| S-23 | | 8/7/20 | 7 | 1,200 | 2 | 680 | 1,882 | 398 | 24 | 422 | 4.76 | 8,968 | 1,896 | 2,011 |
| S-23 | | 8/10/20 | 10 | 1,344 | 2 | 762 | 2,108 | 425 | 27 | 452 | 4.73 | 9,976 | 2,011 | 2,139 |
| S-23 | | 8/13/20 | 13 | 1,611 | 2 | 745 | 2,358 | 467 | 24 | 491 | 4.70 | 11,083 | 2,195 | 2,308 |
| S-23 | | 8/15/20 | 15 | 1,805 | 2 | 798 | 2,605 | 555 | 25 | 580 | 4.68 | 12,187 | 2,597 | 2,714 |
| S-23 | | 8/17/20 | 17 | 2,043 | 2 | 763 | 2,808 | 656 | 26 | 682 | 4.66 | 13,076 | 3,055 | 3,176 |
| S-23 | Anoxic | 8/19/20 | 19 | 2,183 | 2 | 711 | 2,896 | 787 | 24 | 811 | 4.64 | 13,424 | 3,648 | 3,759 |
| S-23 | | 8/21/20 | 21 | 2,247 | 2 | 734 | 2,983 | 994 | 30 | 1,024 | 4.61 | 13,763 | 4,586 | 4,724 |
| S-23 | | 8/25/20 | 25 | 2,470 | 2 | 783 | 3,255 | 1,054 | 27 | 1,081 | 4.57 | 14,877 | 4,817 | 4,941 |
| S-23 | | 8/26/20 | 26 | 2,675 | 2 | 728 | 3,405 | 1,134 | 29 | 1,163 | 4.56 | 15,526 | 5,171 | 5,303 |
| S-23 | | 9/2/20 | 33 | 2,785 | 2 | 761 | 3,548 | 1,198 | 29 | 1,227 | 4.48 | 15,909 | 5,372 | 5,502 |
| S-23 | | 9/4/20 | 35 | 2,859 | 2 | 741 | 3,602 | 1,214 | 30 | 1,244 | 4.46 | 16,074 | 5,417 | 5,551 |
| S-23 | | 9/9/20 | 40 | 2,872 | 2 | 770 | 3,644 | 1,212 | 30 | 1,242 | 4.41 | 16,064 | 5,343 | 5,475 |
| S-23 | | 9/11/20 | 42 | 3,316 | 2 | 755 | 4,073 | 1,250 | 30 | 1,280 | 4.39 | 17,867 | 5,483 | 5,615 |

1 Denotes value < MDL; MDL value is listed

G-2: Sediment Nutrient Release Plots

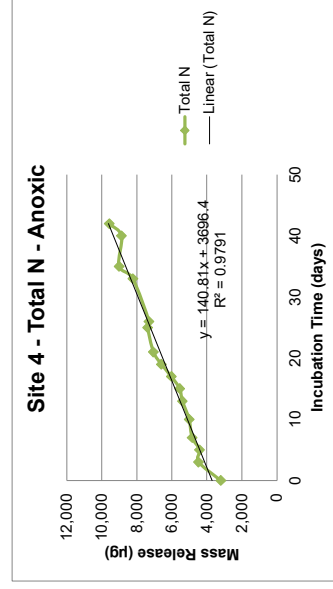
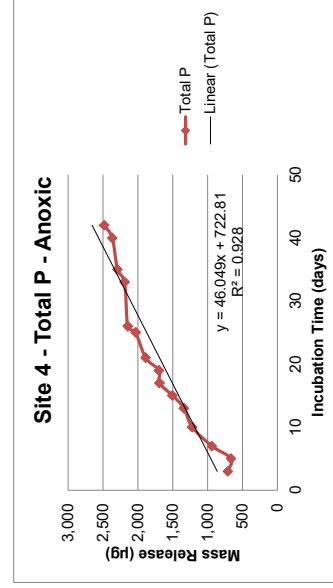
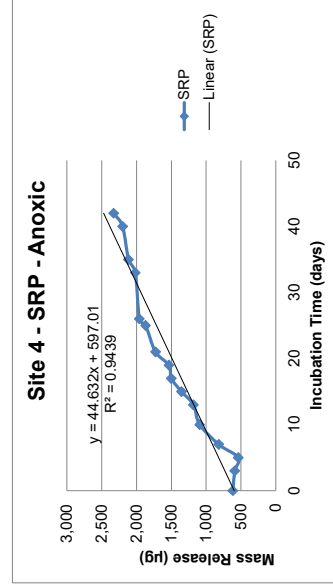
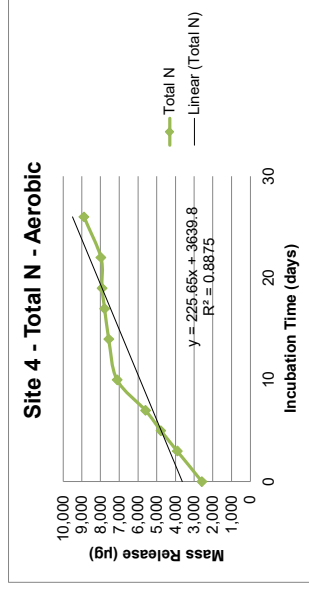
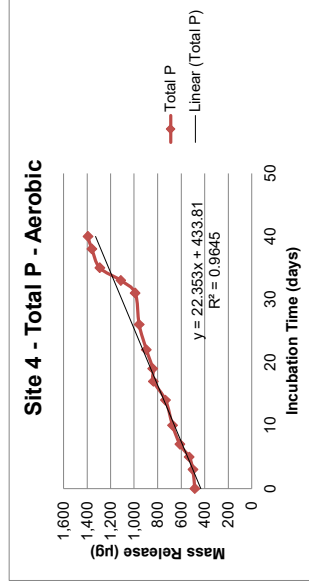
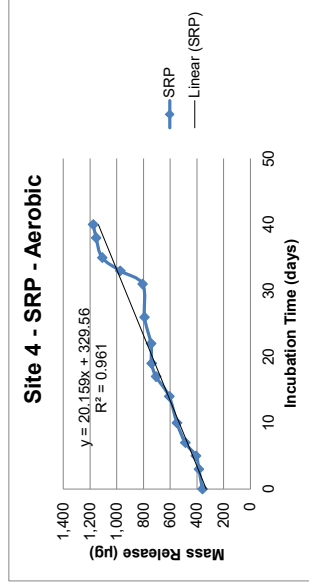
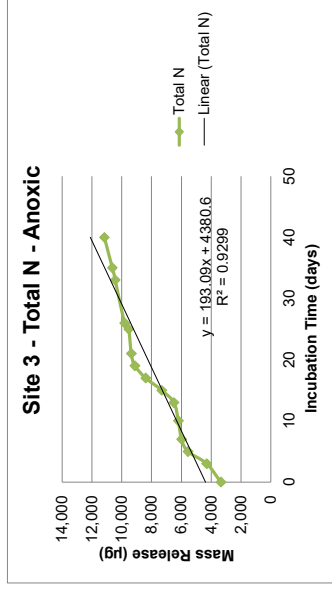
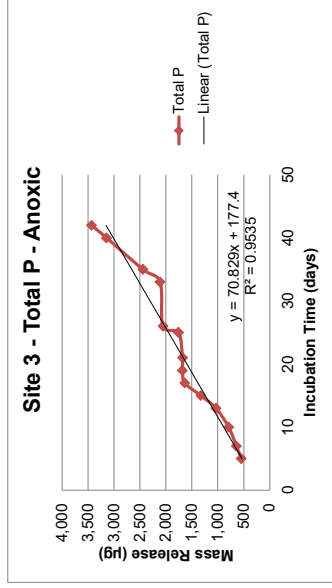
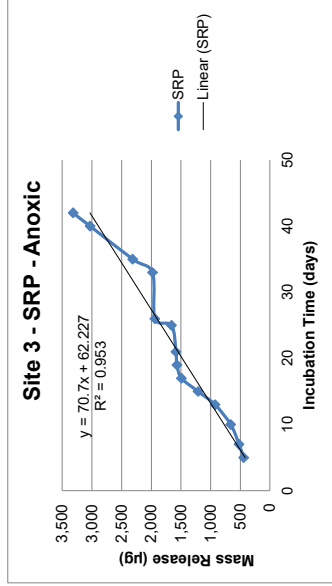
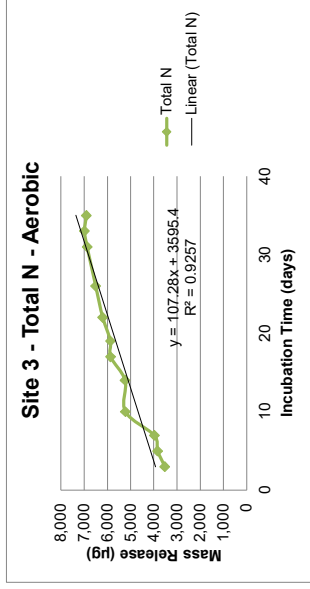
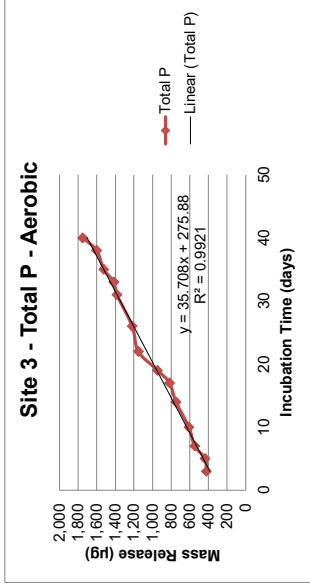
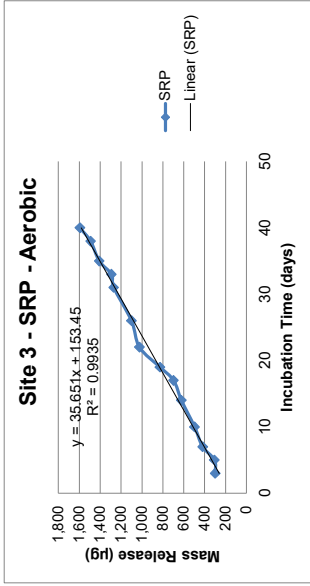

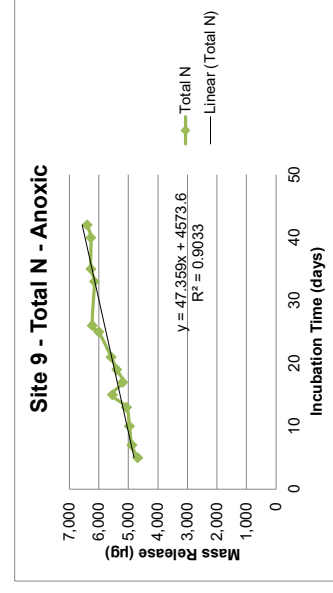
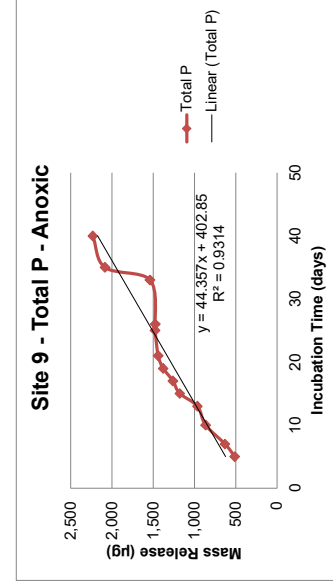
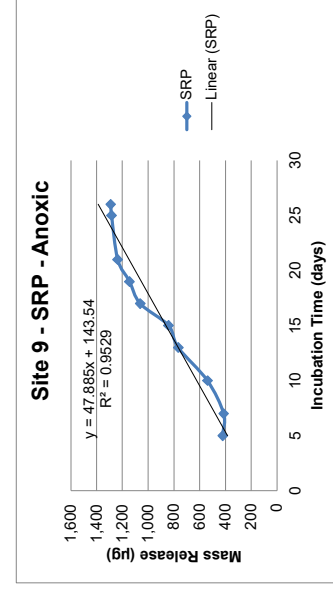
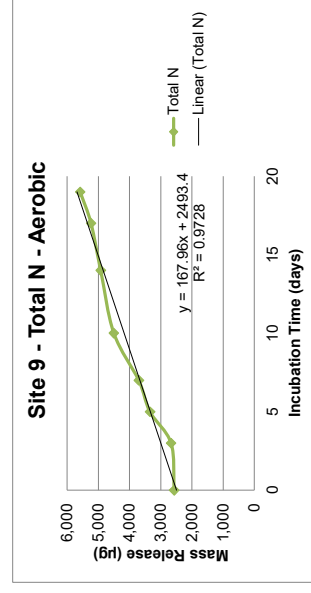
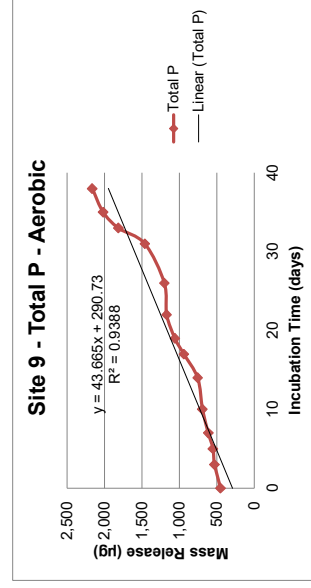
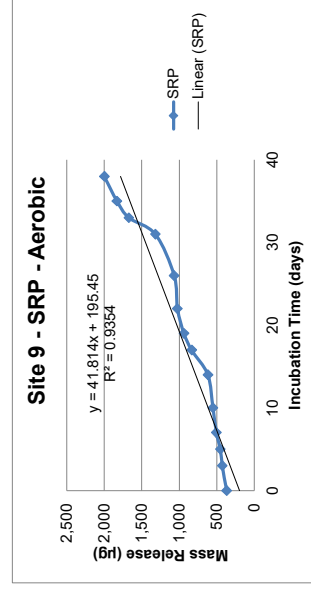
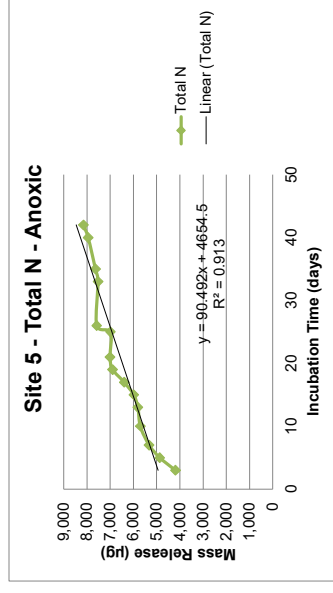
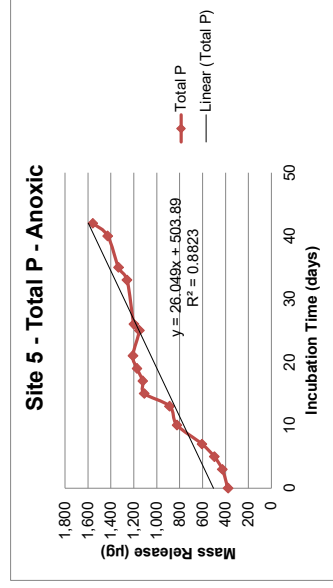
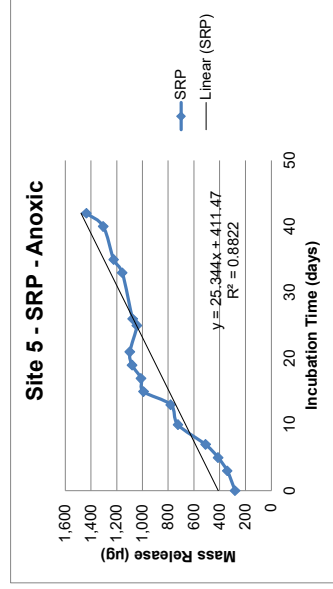
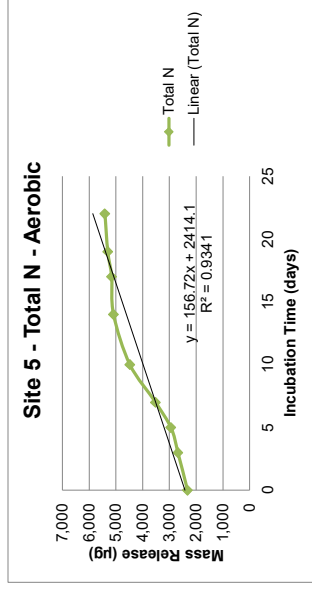
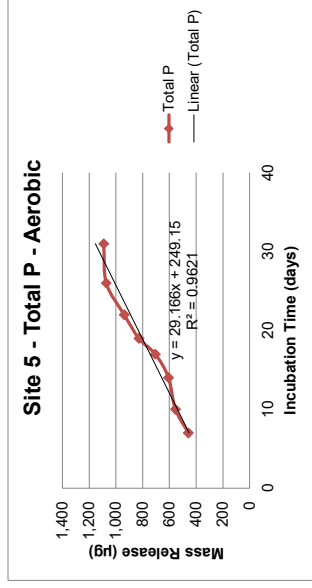
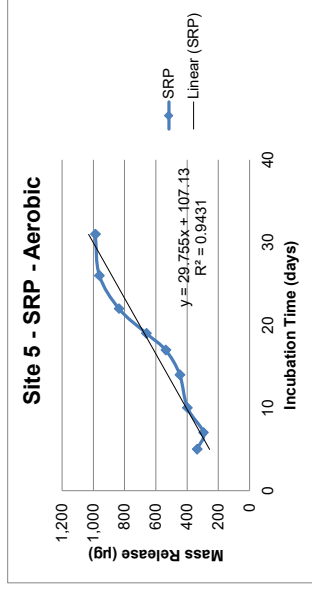

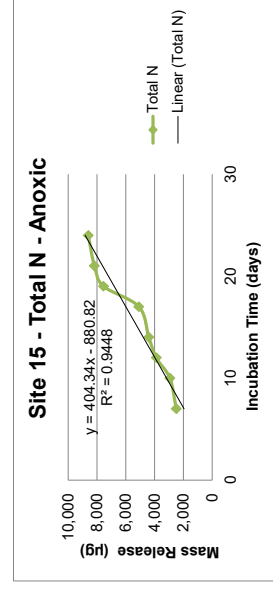
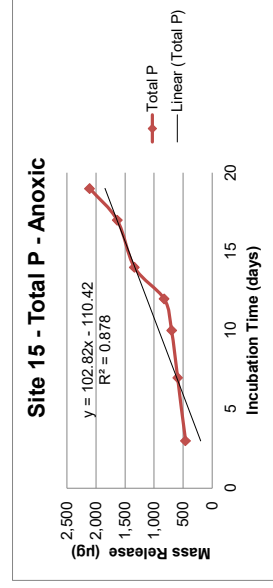
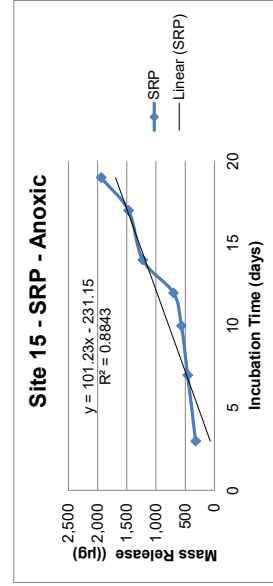
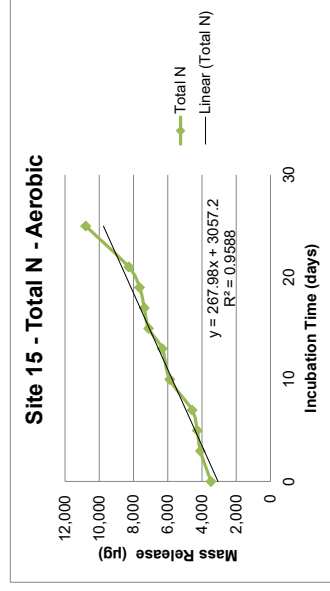
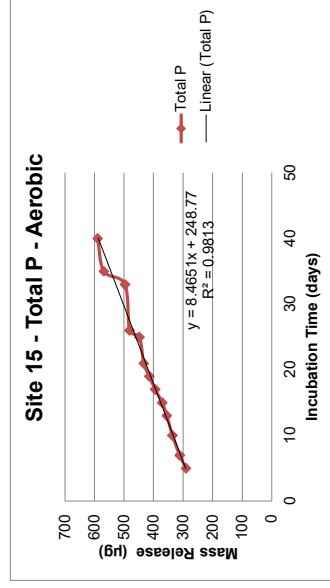
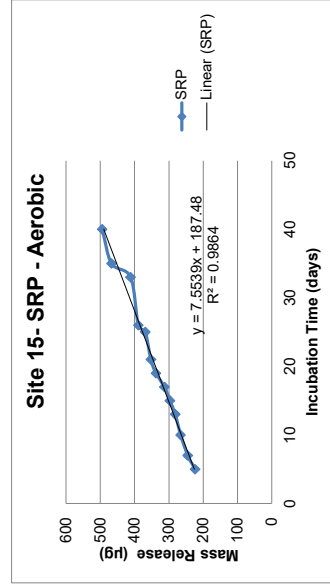
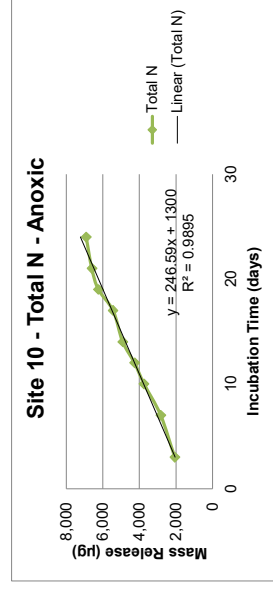
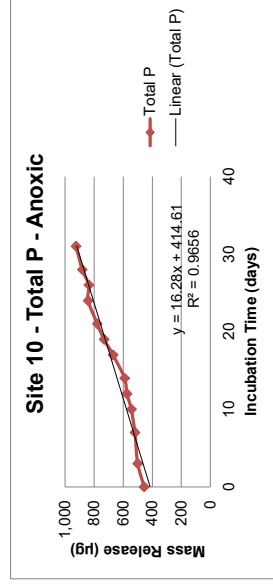
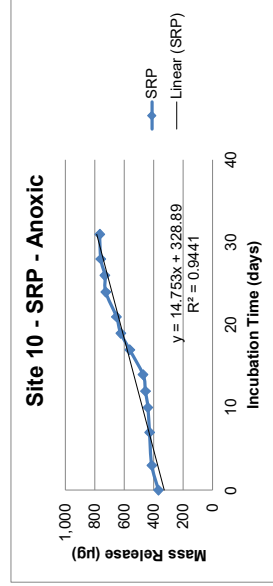
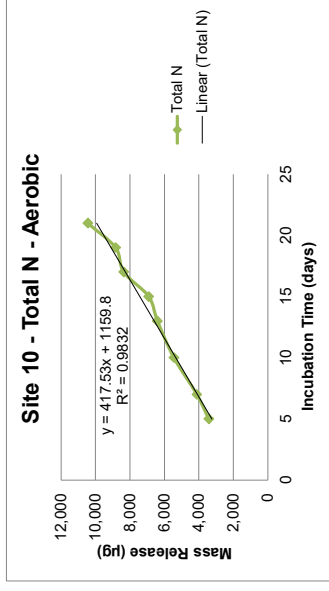
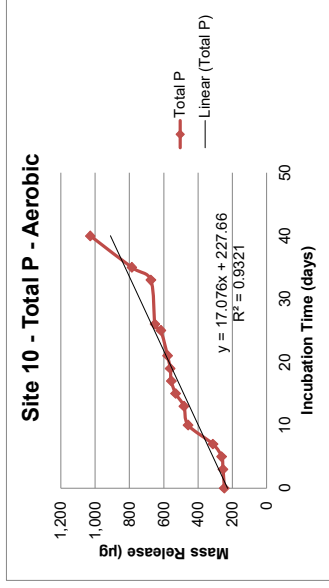
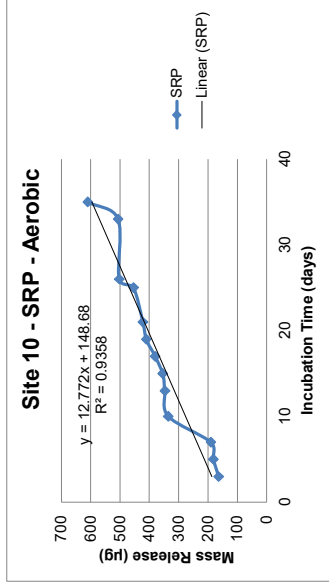

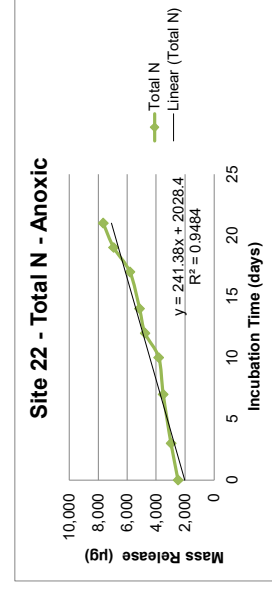
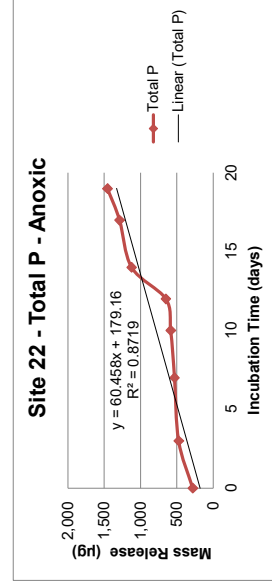
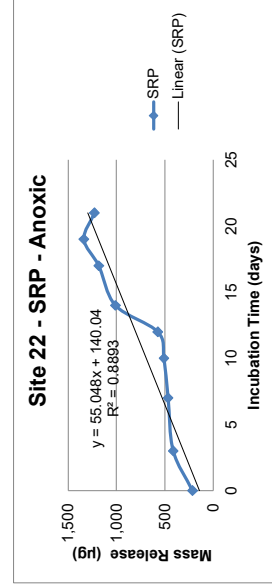
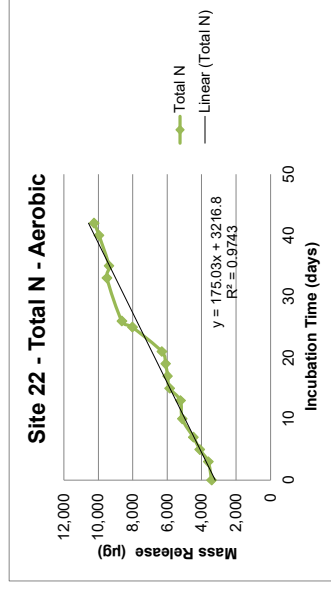
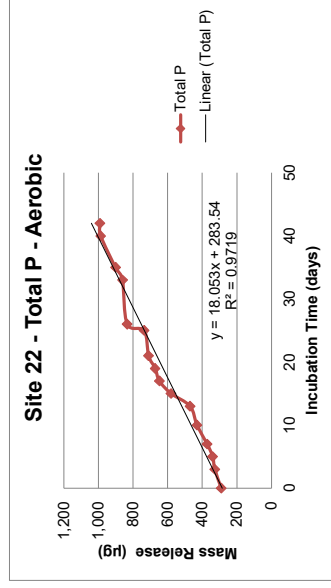
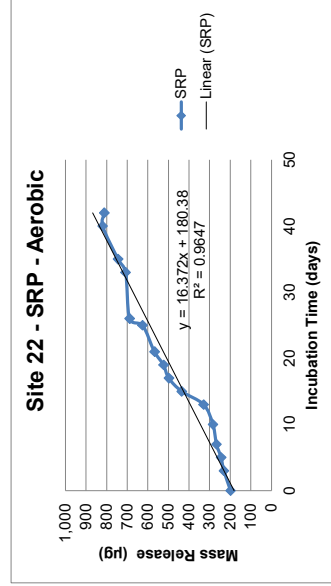
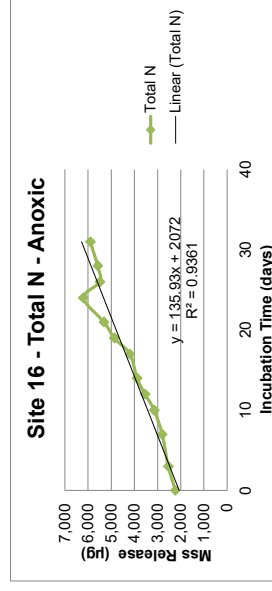
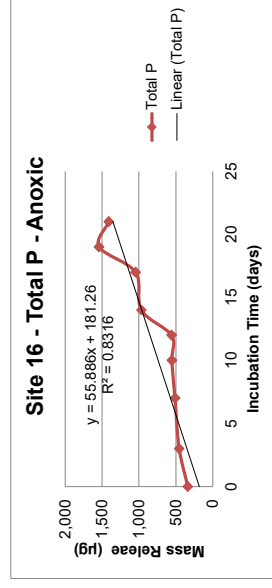
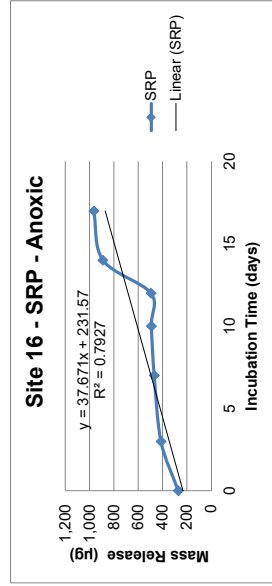
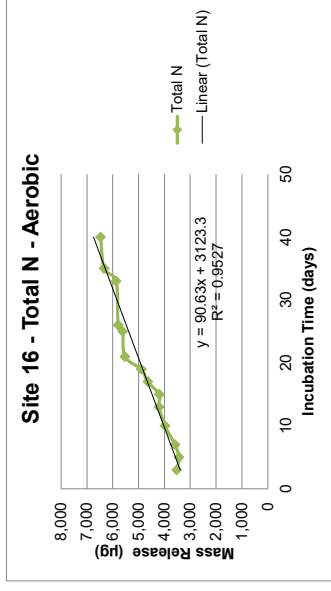
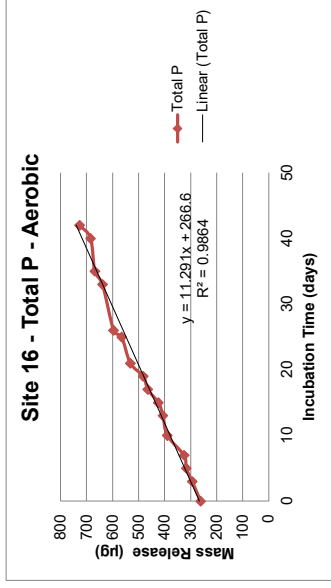
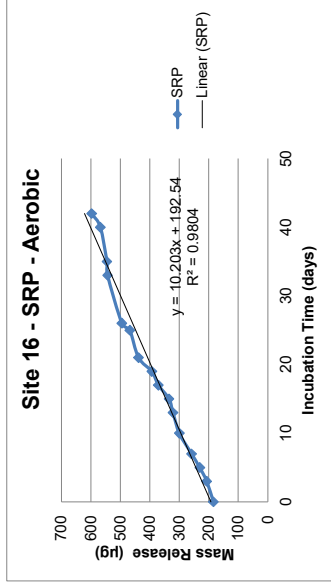

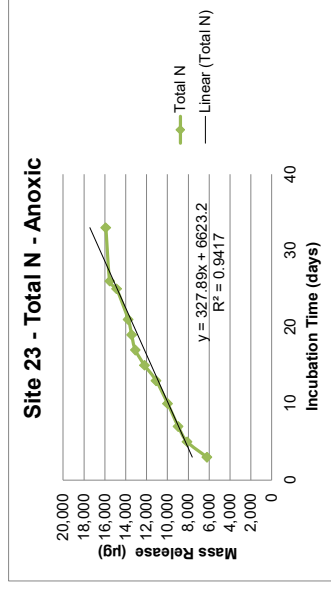
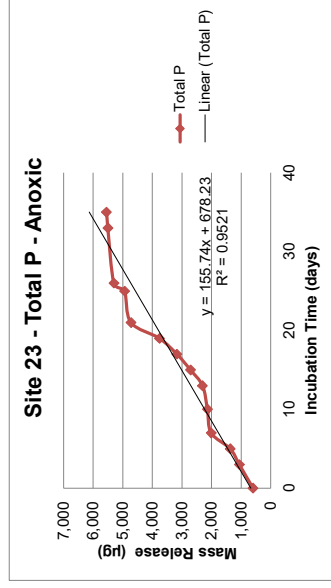
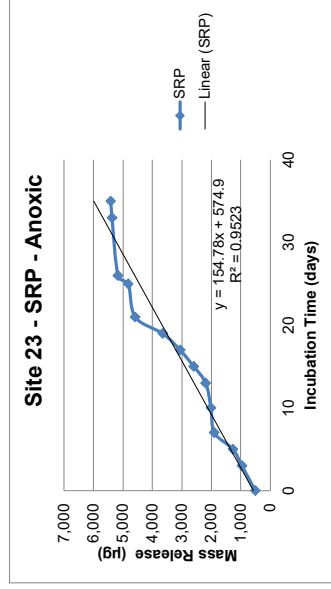
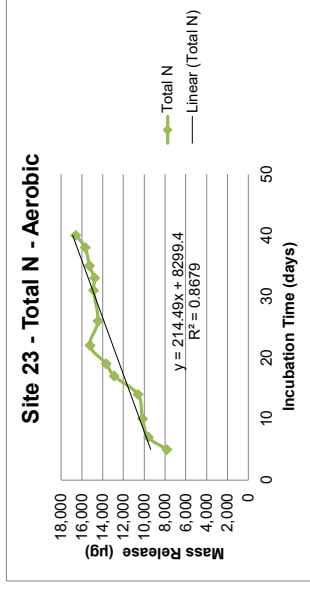
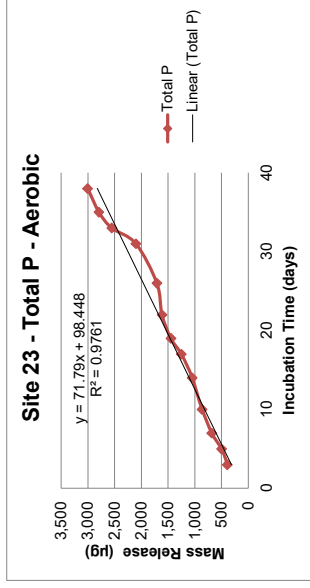
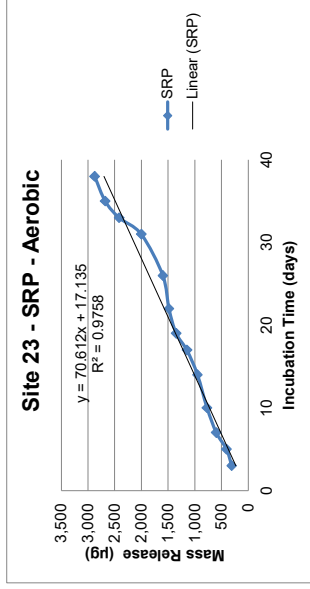

APPENDIX H

**RESULTS OF STABLE
ISOTOPE ANALYSES
CONDUCTED ON MARCO
ISLAND SAMPLES**

H-1: Laboratory Documentation

H-2: Sample Results

H-1: Laboratory Documentation

UNIVERSITY OF CALIFORNIA, DAVIS

BERKELEY • DAVIS • IRVINE • LOS ANGELES • MERCED • RIVERSIDE • SAN DIEGO • SAN FRANCISCO



SANTA BARBARA • SANTA CRUZ

STABLE ISOTOPE FACILITY
 DEPARTMENT OF PLANT SCIENCES
 ONE SHIELDS AVE
 DAVIS, CALIFORNIA 95616
 530-752-8100

UNIVERSITY OF CALIFORNIA
 COLLEGE OF AGRICULTURAL AND
 ENVIRONMENTAL SCIENCES

Stable Isotope Facility Data Report

Principal Investigator: Harvey Harper Email: hharper@erd.org
 Researcher Harry Seenauth Email: hseenauth@erd.org

Institution: Environmental Research and Design

Project: Marco Island

Submission Date: 12/15/20

Report Date: 03/12/21

Analysis: ^{15}N & ^{18}O Analysis of Nitrate (NO_3^-) by Bacterial Denitrification Assay using a GasBench IRMS

| | $\delta^{15}\text{N}$ | $\delta^{18}\text{O}$ |
|---|-----------------------|-----------------------|
| Mean SD for sample material replicates in this project: | $\pm 0.06 \text{ ‰}$ | $\pm 0.30 \text{ ‰}$ |
| Mean SD for reference material replicates in this project: | $\pm 0.16 \text{ ‰}$ | $\pm 0.37 \text{ ‰}$ |
| Mean absolute accuracy for calibrated reference materials within: | $\pm 0.04 \text{ ‰}$ | $\pm 0.27 \text{ ‰}$ |

Notes: Twenty samples are below the limit of quantification (LOQ). Isotope results for samples below the LOQ may not be reliable.

Sample count to be charged: 212

Additional charges: 4 reanalyses due to inaccurate $[\text{NO}_3^-]$ data provided by client

Reported by: Kate Pecsok Ewert
 kepecsok@ucdavis.edu

Please review your data in a timely fashion, so that we may fully address any questions or concerns.

Sample List

| UC Davis Stable Isotope Facility Sample Submission Form | | | | | | | | | | | |
|--|---------------------|-------------|------------------------|--------------------|-----------------------------|-----------|----------------------------|---------|--------------------------|---|--------------------------------|
| Counter | Sample ID | Amount (mL) | Type of water | Source of water | Analysis | Enriched? | Estimated or Enrichment or | pH | Salinity or Conductivity | Concentration of NO ₃ or DOC/DIC | Special Notes |
| Instructions | 20 character limit | integer | 20 character limit | 20 character limit | 20 character limit | Yes or No | 20 character limit | integer | µmho/cm | µg/l as N | |
| Example 1 | PSW 21 | 2 | Filtered seawater | Pugent Sound, WA | 18O/16O of water | No | -10 +/- 3 d18O per mil | 7 | 30 ppt | NA | Ordered in increasing salinity |
| Example 2 | Rainwater 2C | 20 | River, Rainwater, Snow | Klamath Falls, CA | D & 18O of water | No | -55 dD/-8 d18O per mil | 6 to 8 | 0-1 ppt | NA | |
| Example 3 | PF Well 13 | 10 | Tracer study | Paris, France | D/H of water | Yes | -25 to 200 dD per mil | 6 to 8 | 0-10 mS/cm | NA | Enrichment varies < |
| Example 4 | GIC 68 | 1 | Ice core | Greenland | D & 18O of water | No | -200 dD/-25 d18O per mil | 7 | 0 ppt | NA | |
| Example 5 | Bar 2 | 30 | Filtered groundwater | | 13C of DOC | Yes | 1 at% | | < 10 ppt | 3-6 ppm DIC, 12-25 µM NO ₃ | Poisoned with 50% w |
| Example 6 | 100901 a | 25 | Precip | | 18O, 15N of NO ₃ | No | NA | 7 to 9 | NA | 0.539 µM NO ₃ | |
| 1 | 20-1700 Bulk Precip | 50 | Filtered Rainwater | Marco Island, FL | O and N Isotope | No | NA | 7 | 7 | 82 | None |
| 2 | 20-1753 Bulk Precip | 50 | Filtered Rainwater | Marco Island, FL | O and N Isotope | No | NA | 6 | 17 | 92 | None |
| 3 | 20-1871 Bulk Precip | 50 | Filtered Rainwater | Marco Island, FL | O and N Isotope | No | NA | 6 | 26 | 137 | None |
| 4 | 20-2016 Bulk Precip | 50 | Filtered Rainwater | Marco Island, FL | O and N Isotope | No | NA | 7 | 15 | 148 | None |
| 5 | 20-2178 Bulk Precip | 50 | Filtered Rainwater | Marco Island, FL | O and N Isotope | No | NA | 7 | 22 | 184 | None |
| 6 | 20-2310 Bulk Precip | 50 | Filtered Rainwater | Marco Island, FL | O and N Isotope | No | NA | 7 | 18 | 137 | None |
| 7 | 20-2340 Bulk Precip | 50 | Filtered Rainwater | Marco Island, FL | O and N Isotope | No | NA | 6 | 11 | 1 | None |
| 8 | 20-2394 Bulk Precip | 50 | Filtered Rainwater | Marco Island, FL | O and N Isotope | No | NA | 6 | 8 | 80 | None |
| 9 | 20-2497 Bulk Precip | 50 | Filtered Rainwater | Marco Island, FL | O and N Isotope | No | NA | 6 | 7 | 184 | None |
| 10 | 20-2557 Bulk Precip | 50 | Filtered Rainwater | Marco Island, FL | O and N Isotope | No | NA | 6 | 18 | 160 | None |
| 11 | 20-2636 Bulk Precip | 50 | Filtered Rainwater | Marco Island, FL | O and N Isotope | No | NA | 6 | 10 | 100 | None |
| 12 | 20-2709 Bulk Precip | 50 | Filtered Rainwater | Marco Island, FL | O and N Isotope | No | NA | 6 | 31 | 141 | None |
| 13 | 20-2808 Bulk Precip | 50 | Filtered Rainwater | Marco Island, FL | O and N Isotope | No | NA | 6 | 31 | 103 | None |
| 14 | 20-2917 Bulk Precip | 50 | Filtered Rainwater | Marco Island, FL | O and N Isotope | No | NA | 6 | 19 | 113 | None |
| 15 | 20-2940 Bulk Precip | 50 | Filtered Rainwater | Marco Island, FL | O and N Isotope | No | NA | 7 | 30 | 39 | None |
| 16 | 20-3451 Bulk Precip | 50 | Filtered Rainwater | Marco Island, FL | O and N Isotope | No | NA | 6 | 18 | 184 | None |
| 17 | 20-3554 Bulk Precip | 50 | Filtered Rainwater | Marco Island, FL | O and N Isotope | No | NA | 6 | 21 | 98 | None |
| 18 | 20-3727 Bulk Precip | 50 | Filtered Rainwater | Marco Island, FL | O and N Isotope | No | NA | 7 | 28 | 82 | None |
| 19 | 20-2631 MI 01 | 50 | Filtered Stormwater | Marco Island, FL | O and N Isotope | No | NA | 6 | 99 | 95 | None |
| 20 | 20-1551 MI 01 | 50 | Filtered Stormwater | Marco Island, FL | O and N Isotope | No | NA | 8 | 41724 | 119 | None |
| 21 | 20-1638 MI 01 | 50 | Filtered Stormwater | Marco Island, FL | O and N Isotope | No | NA | 8 | 51984 | 176 | None |
| 22 | 20-1696 MI 01 | 50 | Filtered Stormwater | Marco Island, FL | O and N Isotope | No | NA | 8 | 28930 | 93 | None |
| 23 | 20-2335 MI 01 | 50 | Filtered Stormwater | Marco Island, FL | O and N Isotope | No | NA | 8 | 23210 | 107 | None |
| 24 | 20-2389 MI 01 | 50 | Filtered Stormwater | Marco Island, FL | O and N Isotope | No | NA | 7 | 35310 | 102 | None |
| 25 | 20-2492 MI 01 | 50 | Filtered Stormwater | Marco Island, FL | O and N Isotope | No | NA | 8 | 23868 | 80 | None |
| 26 | 20-2554 MI 01 | 50 | Filtered Stormwater | Marco Island, FL | O and N Isotope | No | NA | 8 | 28997 | 435 | None |
| 27 | 20-2935 MI 01 | 50 | Filtered Stormwater | Marco Island, FL | O and N Isotope | No | NA | 7 | 1057 | 55 | None |
| 28 | 20-3078 MI 01 | 50 | Filtered Stormwater | Marco Island, FL | O and N Isotope | No | NA | 8 | 43977 | 159 | None |
| 29 | 20-3169 MI 01 | 50 | Filtered Stormwater | Marco Island, FL | O and N Isotope | No | NA | 7 | 27878 | 105 | None |
| 30 | 20-3239 MI 01 | 50 | Filtered Stormwater | Marco Island, FL | O and N Isotope | No | NA | 7 | 29256 | 195 | None |
| 31 | 20-3323 MI 01 | 50 | Filtered Stormwater | Marco Island, FL | O and N Isotope | No | NA | 8 | 40664 | 135 | None |
| 32 | 20-3552 MI 01 | 50 | Filtered Stormwater | Marco Island, FL | O and N Isotope | No | NA | 7 | 45114 | 208 | None |
| 33 | 20-1697 MI 02 | 50 | Filtered Stormwater | Marco Island, FL | O and N Isotope | No | NA | 8 | 1676 | 122 | None |
| 34 | 20-2306 MI 02 | 50 | Filtered Stormwater | Marco Island, FL | O and N Isotope | No | NA | 7 | 3718 | 133 | None |
| 35 | 20-2336 MI 02 | 50 | Filtered Stormwater | Marco Island, FL | O and N Isotope | No | NA | 7 | 1581 | 23 | None |
| 36 | 20-2493 MI 02 | 50 | Filtered Stormwater | Marco Island, FL | O and N Isotope | No | NA | 8 | 1117 | 0 | None |

Sample List

| | | | | | | | | | | | |
|----|---------------|----|---------------------|------------------|-----------------|----|----|---|-------|------|------|
| 37 | 20-2555 MI 02 | 50 | Filtered Stormwater | Marco Island, FL | O and N Isotope | No | NA | 8 | 1464 | 101 | None |
| 38 | 20-1639 MI 02 | 50 | Filtered Stormwater | Marco Island, FL | O and N Isotope | No | NA | 8 | 53352 | 82 | None |
| 39 | 20-2015 MI 02 | 50 | Filtered Stormwater | Marco Island, FL | O and N Isotope | No | NA | 8 | 48941 | 0 | None |
| 40 | 20-2054 MI 02 | 50 | Filtered Stormwater | Marco Island, FL | O and N Isotope | No | NA | 8 | 50794 | 23 | None |
| 41 | 20-2175 MI 02 | 50 | Filtered Stormwater | Marco Island, FL | O and N Isotope | No | NA | 8 | 48950 | 3 | None |
| 42 | 20-2390 MI 02 | 50 | Filtered Stormwater | Marco Island, FL | O and N Isotope | No | NA | 8 | 21670 | 0 | None |
| 43 | 20-2632 MI 02 | 50 | Filtered Stormwater | Marco Island, FL | O and N Isotope | No | NA | 8 | 37129 | 107 | None |
| 44 | 20-2705 MI 02 | 50 | Filtered Stormwater | Marco Island, FL | O and N Isotope | No | NA | 8 | 47064 | 40 | None |
| 45 | 20-2914 MI 02 | 50 | Filtered Stormwater | Marco Island, FL | O and N Isotope | No | NA | 8 | 52644 | 0 | None |
| 46 | 20-2936 MI 02 | 50 | Filtered Stormwater | Marco Island, FL | O and N Isotope | No | NA | 7 | 1441 | 0 | None |
| 47 | 20-3079 MI 02 | 50 | Filtered Stormwater | Marco Island, FL | O and N Isotope | No | NA | 8 | 43228 | 147 | None |
| 48 | 20-3324 MI 02 | 50 | Filtered Stormwater | Marco Island, FL | O and N Isotope | No | NA | 8 | 43784 | 30 | None |
| 49 | 20-3447 MI 02 | 50 | Filtered Stormwater | Marco Island, FL | O and N Isotope | No | NA | 8 | 52520 | 50 | None |
| 50 | 20-3725 MI 02 | 50 | Filtered Stormwater | Marco Island, FL | O and N Isotope | No | NA | 8 | 43800 | 247 | None |
| 51 | 20-1552 MI 03 | 50 | Filtered Stormwater | Marco Island, FL | O and N Isotope | No | NA | 9 | 967 | 288 | None |
| 52 | 20-1698 MI 03 | 50 | Filtered Stormwater | Marco Island, FL | O and N Isotope | No | NA | 8 | 1191 | 69 | None |
| 53 | 20-1751 MI 03 | 50 | Filtered Stormwater | Marco Island, FL | O and N Isotope | No | NA | 9 | 738 | 1863 | None |
| 54 | 20-1869 MI 03 | 50 | Filtered Stormwater | Marco Island, FL | O and N Isotope | No | NA | 7 | 2000 | 6 | None |
| 55 | 20-2337 MI 03 | 50 | Filtered Stormwater | Marco Island, FL | O and N Isotope | No | NA | 7 | 1064 | 94 | None |
| 56 | 20-2494 MI 03 | 50 | Filtered Stormwater | Marco Island, FL | O and N Isotope | No | NA | 7 | 747 | 45 | None |
| 57 | 20-2633 MI 03 | 50 | Filtered Stormwater | Marco Island, FL | O and N Isotope | No | NA | 7 | 97 | 66 | None |
| 58 | 20-1640 MI 03 | 50 | Filtered Stormwater | Marco Island, FL | O and N Isotope | No | NA | 8 | 32604 | 264 | None |
| 59 | 20-2055 MI 03 | 50 | Filtered Stormwater | Marco Island, FL | O and N Isotope | No | NA | 7 | 26269 | 2 | None |
| 60 | 20-2176 MI 03 | 50 | Filtered Stormwater | Marco Island, FL | O and N Isotope | No | NA | 7 | 29150 | 17 | None |
| 61 | 20-2307 MI 03 | 50 | Filtered Stormwater | Marco Island, FL | O and N Isotope | No | NA | 7 | 22220 | 12 | None |
| 62 | 20-2391 MI 03 | 50 | Filtered Stormwater | Marco Island, FL | O and N Isotope | No | NA | 7 | 24860 | 0 | None |
| 63 | 20-2706 MI 03 | 50 | Filtered Stormwater | Marco Island, FL | O and N Isotope | No | NA | 7 | 3127 | 357 | None |
| 64 | 20-2915 MI 03 | 50 | Filtered Stormwater | Marco Island, FL | O and N Isotope | No | NA | 7 | 268 | 256 | None |
| 65 | 20-2937 MI 03 | 50 | Filtered Stormwater | Marco Island, FL | O and N Isotope | No | NA | 7 | 127 | 178 | None |
| 66 | 20-3080 MI 03 | 50 | Filtered Stormwater | Marco Island, FL | O and N Isotope | No | NA | 7 | 30602 | 16 | None |
| 67 | 20-3448 MI 03 | 50 | Filtered Stormwater | Marco Island, FL | O and N Isotope | No | NA | 7 | 38896 | 737 | None |
| 68 | 20-1699 MI 04 | 50 | Filtered Stormwater | Marco Island, FL | O and N Isotope | No | NA | 8 | 2376 | 82 | None |
| 69 | 20-1752 MI 04 | 50 | Filtered Stormwater | Marco Island, FL | O and N Isotope | No | NA | 8 | 1824 | 26 | None |
| 70 | 20-1870 MI 04 | 50 | Filtered Stormwater | Marco Island, FL | O and N Isotope | No | NA | 7 | 90 | 137 | None |
| 71 | 20-2308 MI 04 | 50 | Filtered Stormwater | Marco Island, FL | O and N Isotope | No | NA | 8 | 474 | 357 | None |
| 72 | 20-2338 MI 04 | 50 | Filtered Stormwater | Marco Island, FL | O and N Isotope | No | NA | 8 | 1420 | 225 | None |
| 73 | 20-2495 MI 04 | 50 | Filtered Stormwater | Marco Island, FL | O and N Isotope | No | NA | 8 | 1206 | 331 | None |
| 74 | 20-1641 MI 04 | 50 | Filtered Stormwater | Marco Island, FL | O and N Isotope | No | NA | 8 | 16997 | 12 | None |
| 75 | 20-2177 MI 04 | 50 | Filtered Stormwater | Marco Island, FL | O and N Isotope | No | NA | 8 | 5379 | 620 | None |
| 76 | 20-2392 MI 04 | 50 | Filtered Stormwater | Marco Island, FL | O and N Isotope | No | NA | 8 | 26950 | 167 | None |
| 77 | 20-2634 MI 04 | 50 | Filtered Stormwater | Marco Island, FL | O and N Isotope | No | NA | 8 | 41409 | 79 | None |
| 78 | 20-2707 MI 04 | 50 | Filtered Stormwater | Marco Island, FL | O and N Isotope | No | NA | 8 | 40386 | 133 | None |
| 79 | 20-2938 MI 04 | 50 | Filtered Stormwater | Marco Island, FL | O and N Isotope | No | NA | 7 | 906 | 65 | None |
| 80 | 20-3081 MI 04 | 50 | Filtered Stormwater | Marco Island, FL | O and N Isotope | No | NA | 7 | 35952 | 435 | None |
| 81 | 20-3170 MI 04 | 50 | Filtered Stormwater | Marco Island, FL | O and N Isotope | No | NA | 8 | 42506 | 850 | None |
| 82 | 20-3240 MI 04 | 50 | Filtered Stormwater | Marco Island, FL | O and N Isotope | No | NA | 8 | 19854 | 616 | None |
| 83 | 20-3325 MI 04 | 50 | Filtered Stormwater | Marco Island, FL | O and N Isotope | No | NA | 8 | 887 | 1075 | None |
| 84 | 20-3449 MI 04 | 50 | Filtered Stormwater | Marco Island, FL | O and N Isotope | No | NA | 7 | 41912 | 128 | None |
| 85 | 20-2635 MI 05 | 50 | Filtered Stormwater | Marco Island, FL | O and N Isotope | No | NA | 8 | 163 | 101 | None |
| 86 | 20-2309 MI 05 | 50 | Filtered Stormwater | Marco Island, FL | O and N Isotope | No | NA | 8 | 36410 | 162 | None |
| 87 | 20-2339 MI 05 | 50 | Filtered Stormwater | Marco Island, FL | O and N Isotope | No | NA | 8 | 30910 | 17 | None |
| 88 | 20-2393 MI 05 | 50 | Filtered Stormwater | Marco Island, FL | O and N Isotope | No | NA | 9 | 30910 | 272 | None |

Sample List

| | | | | | | | | | | | |
|-----|--------------------|----|---------------------|------------------|-----------------|----|----|---|-------|-------|------|
| 89 | 20-2496 MI 05 | 50 | Filtered Stormwater | Marco Island, FL | O and N Isotope | No | NA | 7 | 29376 | 104 | None |
| 90 | 20-2556 MI 05 | 50 | Filtered Stormwater | Marco Island, FL | O and N Isotope | No | NA | 8 | 33277 | 284 | None |
| 91 | 20-2708 MI 05 | 50 | Filtered Stormwater | Marco Island, FL | O and N Isotope | No | NA | 8 | 242 | 70 | None |
| 92 | 20-2916 MI 05 | 50 | Filtered Stormwater | Marco Island, FL | O and N Isotope | No | NA | 7 | 669 | 61 | None |
| 93 | 20-2939 MI 05 | 50 | Filtered Stormwater | Marco Island, FL | O and N Isotope | No | NA | 8 | 263 | 0 | None |
| 94 | 20-3082 MI 05 | 50 | Filtered Stormwater | Marco Island, FL | O and N Isotope | No | NA | 8 | 24075 | 528 | None |
| 95 | 20-3171 MI 05 | 50 | Filtered Stormwater | Marco Island, FL | O and N Isotope | No | NA | 8 | 17914 | 864 | None |
| 96 | 20-3241 MI 05 | 50 | Filtered Stormwater | Marco Island, FL | O and N Isotope | No | NA | 8 | 4950 | 393 | None |
| 97 | 20-3326 MI 05 | 50 | Filtered Stormwater | Marco Island, FL | O and N Isotope | No | NA | 8 | 28704 | 737 | None |
| 98 | 20-3450 MI 05 | 50 | Filtered Stormwater | Marco Island, FL | O and N Isotope | No | NA | 8 | 41392 | 231 | None |
| 99 | 20-3553 MI 05 | 50 | Filtered Stormwater | Marco Island, FL | O and N Isotope | No | NA | 8 | 23072 | 325 | None |
| 100 | 20-3726 MI 05 | 50 | Filtered Stormwater | Marco Island, FL | O and N Isotope | No | NA | 8 | 36400 | 806 | None |
| 101 | 20-1550 Reuse | 50 | Filtered Stormwater | Marco Island, FL | O and N Isotope | No | NA | 7 | 1422 | 7242 | None |
| 102 | 20-1637 Reuse | 50 | Filtered Stormwater | Marco Island, FL | O and N Isotope | No | NA | 8 | 1831 | 3012 | None |
| 103 | 20-1695 Reuse | 50 | Filtered Stormwater | Marco Island, FL | O and N Isotope | No | NA | 8 | 1243 | 3648 | None |
| 104 | 20-1750 Reuse | 50 | Filtered Stormwater | Marco Island, FL | O and N Isotope | No | NA | 7 | 1467 | 3747 | None |
| 105 | 20-1868 Reuse | 50 | Filtered Stormwater | Marco Island, FL | O and N Isotope | No | NA | 7 | 1270 | 4139 | None |
| 106 | 20-2014 Reuse | 50 | Filtered Stormwater | Marco Island, FL | O and N Isotope | No | NA | 7 | 1242 | 3226 | None |
| 107 | 20-2053 Reuse | 50 | Filtered Stormwater | Marco Island, FL | O and N Isotope | No | NA | 7 | 1571 | 4572 | None |
| 108 | 20-2174 Reuse | 50 | Filtered Stormwater | Marco Island, FL | O and N Isotope | No | NA | 7 | 1475 | 2716 | None |
| 109 | 20-2305 Reuse | 50 | Filtered Stormwater | Marco Island, FL | O and N Isotope | No | NA | 7 | 1173 | 3240 | None |
| 110 | 20-2334 Reuse | 50 | Filtered Stormwater | Marco Island, FL | O and N Isotope | No | NA | 7 | 1311 | 800 | None |
| 111 | 20-2388 Reuse | 50 | Filtered Stormwater | Marco Island, FL | O and N Isotope | No | NA | 7 | 1308 | 2932 | None |
| 112 | 20-2491 Reuse | 50 | Filtered Stormwater | Marco Island, FL | O and N Isotope | No | NA | 7 | 1327 | 806 | None |
| 113 | 20-2553 Reuse | 50 | Filtered Stormwater | Marco Island, FL | O and N Isotope | No | NA | 7 | 1379 | 6935 | None |
| 114 | 20-2630 Reuse | 50 | Filtered Stormwater | Marco Island, FL | O and N Isotope | No | NA | 7 | 1283 | 3631 | None |
| 115 | 20-2704 Reuse | 50 | Filtered Stormwater | Marco Island, FL | O and N Isotope | No | NA | 7 | 1356 | 3163 | None |
| 116 | 20-2807 Reuse | 50 | Filtered Stormwater | Marco Island, FL | O and N Isotope | No | NA | 8 | 1594 | 3883 | None |
| 117 | 20-2913 Reuse | 50 | Filtered Stormwater | Marco Island, FL | O and N Isotope | No | NA | 8 | 1436 | 5161 | None |
| 118 | 20-2934 Reuse | 50 | Filtered Stormwater | Marco Island, FL | O and N Isotope | No | NA | 7 | 1191 | 4326 | None |
| 119 | 20-3077 Reuse | 50 | Filtered Stormwater | Marco Island, FL | O and N Isotope | No | NA | 7 | 1596 | 11105 | None |
| 120 | 20-3168 Reuse | 50 | Filtered Stormwater | Marco Island, FL | O and N Isotope | No | NA | 8 | 1338 | 7375 | None |
| 121 | 20-3238 Reuse | 50 | Filtered Stormwater | Marco Island, FL | O and N Isotope | No | NA | 7 | 935 | 4216 | None |
| 122 | 20-3322 Reuse | 50 | Filtered Stormwater | Marco Island, FL | O and N Isotope | No | NA | 7 | 1933 | 4478 | None |
| 123 | 20-3446 Reuse | 50 | Filtered Stormwater | Marco Island, FL | O and N Isotope | No | NA | 7 | 1557 | 3410 | None |
| 124 | 20-3551 Reuse | 50 | Filtered Stormwater | Marco Island, FL | O and N Isotope | No | NA | 8 | 1844 | 300 | None |
| 125 | 20-2498 Reuse Pond | 50 | Filtered Stormwater | Marco Island, FL | O and N Isotope | No | NA | 7 | 1237 | 0 | None |
| 126 | 20-2637 Reuse Pond | 50 | Filtered Stormwater | Marco Island, FL | O and N Isotope | No | NA | 8 | 1773 | 290 | None |
| 127 | 20-2558 Reuse Pond | 50 | Filtered Stormwater | Marco Island, FL | O and N Isotope | No | NA | 7 | 16157 | 0 | None |
| 128 | 20-2710 Reuse Pond | 50 | Filtered Stormwater | Marco Island, FL | O and N Isotope | No | NA | 7 | 19186 | 0 | None |
| 129 | 20-2809 Reuse Pond | 50 | Filtered Stormwater | Marco Island, FL | O and N Isotope | No | NA | 8 | 24824 | 0 | None |
| 130 | 20-2918 Reuse Pond | 50 | Filtered Stormwater | Marco Island, FL | O and N Isotope | No | NA | 8 | 1757 | 0 | None |
| 131 | 20-2941 Reuse Pond | 50 | Filtered Stormwater | Marco Island, FL | O and N Isotope | No | NA | 8 | 3681 | 0 | None |
| 132 | 20-3083 Reuse Pond | 50 | Filtered Stormwater | Marco Island, FL | O and N Isotope | No | NA | 8 | 15750 | 0 | None |
| 133 | 20-3172 Reuse Pond | 50 | Filtered Stormwater | Marco Island, FL | O and N Isotope | No | NA | 8 | 13155 | 0 | None |
| 134 | 20-3243 Reuse Pond | 50 | Filtered Stormwater | Marco Island, FL | O and N Isotope | No | NA | 7 | 13420 | 45 | None |
| 135 | 20-3327 Reuse Pond | 50 | Filtered Stormwater | Marco Island, FL | O and N Isotope | No | NA | 7 | 24128 | 132 | None |
| 136 | 20-3452 Reuse Pond | 50 | Filtered Stormwater | Marco Island, FL | O and N Isotope | No | NA | 8 | 29016 | 105 | None |
| 137 | 20-3555 Reuse Pond | 50 | Filtered Stormwater | Marco Island, FL | O and N Isotope | No | NA | 8 | 27192 | 31 | None |
| 138 | 20-2396 SP 1 | 50 | Filtered Seepage | Marco Island, FL | O and N Isotope | No | NA | 8 | 47190 | 603 | None |
| 139 | 20-2812 SP 1 | 50 | Filtered Seepage | Marco Island, FL | O and N Isotope | No | NA | 8 | 46652 | 414 | None |
| 140 | 20-3091 SP 1 | 50 | Filtered Seepage | Marco Island, FL | O and N Isotope | No | NA | 7 | 43248 | 548 | None |

Sample List

| | | | | | | | | | | | |
|-----|---------------|----|------------------|------------------|-----------------|----|----|---|-------|------|------|
| 141 | 20-3729 SP 1 | 50 | Filtered Seepage | Marco Island, FL | O and N Isotope | No | NA | 7 | 47400 | 631 | None |
| 142 | 20-2058 SP 2 | 50 | Filtered Seepage | Marco Island, FL | O and N Isotope | No | NA | 8 | 50140 | 142 | None |
| 143 | 20-2397 SP 2 | 50 | Filtered Seepage | Marco Island, FL | O and N Isotope | No | NA | 8 | 45210 | 236 | None |
| 144 | 20-2813 SP 2 | 50 | Filtered Seepage | Marco Island, FL | O and N Isotope | No | NA | 8 | 42620 | 211 | None |
| 145 | 20-3092 SP 2 | 50 | Filtered Seepage | Marco Island, FL | O and N Isotope | No | NA | 8 | 37418 | 257 | None |
| 146 | 20-3730 SP 2 | 50 | Filtered Seepage | Marco Island, FL | O and N Isotope | No | NA | 8 | 43400 | 435 | None |
| 147 | 20-2059 SP 3 | 50 | Filtered Seepage | Marco Island, FL | O and N Isotope | No | NA | 8 | 50794 | 172 | None |
| 148 | 20-2398 SP 3 | 50 | Filtered Seepage | Marco Island, FL | O and N Isotope | No | NA | 8 | 46860 | 169 | None |
| 149 | 20-2814 SP 3 | 50 | Filtered Seepage | Marco Island, FL | O and N Isotope | No | NA | 8 | 46117 | 124 | None |
| 150 | 20-3093 SP 3 | 50 | Filtered Seepage | Marco Island, FL | O and N Isotope | No | NA | 8 | 40068 | 88 | None |
| 151 | 20-3731 SP 3 | 50 | Filtered Seepage | Marco Island, FL | O and N Isotope | No | NA | 7 | 47000 | 219 | None |
| 152 | 20-2060 SP 4 | 50 | Filtered Seepage | Marco Island, FL | O and N Isotope | No | NA | 8 | 52211 | 163 | None |
| 153 | 20-2400 SP 4 | 50 | Filtered Seepage | Marco Island, FL | O and N Isotope | No | NA | 8 | 43560 | 341 | None |
| 154 | 20-2815 SP 4 | 50 | Filtered Seepage | Marco Island, FL | O and N Isotope | No | NA | 8 | 47401 | 203 | None |
| 155 | 20-3094 SP 4 | 50 | Filtered Seepage | Marco Island, FL | O and N Isotope | No | NA | 8 | 44838 | 130 | None |
| 156 | 20-3732 SP 4 | 50 | Filtered Seepage | Marco Island, FL | O and N Isotope | No | NA | 8 | 47300 | 329 | None |
| 157 | 20-2062 SP 5 | 50 | Filtered Seepage | Marco Island, FL | O and N Isotope | No | NA | 8 | 49922 | 548 | None |
| 158 | 20-2817 SP 5 | 50 | Filtered Seepage | Marco Island, FL | O and N Isotope | No | NA | 8 | 46652 | 88 | None |
| 159 | 20-3095 SP 5 | 50 | Filtered Seepage | Marco Island, FL | O and N Isotope | No | NA | 8 | 37736 | 155 | None |
| 160 | 20-3733 SP 5 | 50 | Filtered Seepage | Marco Island, FL | O and N Isotope | No | NA | 8 | 47100 | 104 | None |
| 161 | 20-2063 SP 6 | 50 | Filtered Seepage | Marco Island, FL | O and N Isotope | No | NA | 8 | 40221 | 110 | None |
| 162 | 20-2401 SP 6 | 50 | Filtered Seepage | Marco Island, FL | O and N Isotope | No | NA | 8 | 45540 | 90 | None |
| 163 | 20-2818 SP 6 | 50 | Filtered Seepage | Marco Island, FL | O and N Isotope | No | NA | 8 | 44726 | 0 | None |
| 164 | 20-3096 SP 6 | 50 | Filtered Seepage | Marco Island, FL | O and N Isotope | No | NA | 7 | 37524 | 124 | None |
| 165 | 20-2064 SP 7 | 50 | Filtered Seepage | Marco Island, FL | O and N Isotope | No | NA | 8 | 49813 | 97 | None |
| 166 | 20-2402 SP 7 | 50 | Filtered Seepage | Marco Island, FL | O and N Isotope | No | NA | 8 | 47080 | 541 | None |
| 167 | 20-2820 SP 7 | 50 | Filtered Seepage | Marco Island, FL | O and N Isotope | No | NA | 8 | 3863 | 419 | None |
| 168 | 20-2065 SP 8 | 50 | Filtered Seepage | Marco Island, FL | O and N Isotope | No | NA | 8 | 50576 | 1034 | None |
| 169 | 20-2404 SP 8 | 50 | Filtered Seepage | Marco Island, FL | O and N Isotope | No | NA | 8 | 48510 | 347 | None |
| 170 | 20-2821 SP 8 | 50 | Filtered Seepage | Marco Island, FL | O and N Isotope | No | NA | 8 | 44298 | 188 | None |
| 171 | 20-3097 SP 8 | 50 | Filtered Seepage | Marco Island, FL | O and N Isotope | No | NA | 7 | 39220 | 0 | None |
| 172 | 20-3734 SP 8 | 50 | Filtered Seepage | Marco Island, FL | O and N Isotope | No | NA | 8 | 42400 | 191 | None |
| 173 | 20-2066 SP 9 | 50 | Filtered Seepage | Marco Island, FL | O and N Isotope | No | NA | 8 | 50794 | 145 | None |
| 174 | 20-2405 SP 9 | 50 | Filtered Seepage | Marco Island, FL | O and N Isotope | No | NA | 8 | 47520 | 205 | None |
| 175 | 20-2822 SP 9 | 50 | Filtered Seepage | Marco Island, FL | O and N Isotope | No | NA | 8 | 44940 | 481 | None |
| 176 | 20-3099 SP 9 | 50 | Filtered Seepage | Marco Island, FL | O and N Isotope | No | NA | 8 | 43460 | 159 | None |
| 177 | 20-2068 SP 10 | 50 | Filtered Seepage | Marco Island, FL | O and N Isotope | No | NA | 8 | 50685 | 2018 | None |
| 178 | 20-2406 SP 10 | 50 | Filtered Seepage | Marco Island, FL | O and N Isotope | No | NA | 8 | 46090 | 600 | None |
| 179 | 20-2823 SP 10 | 50 | Filtered Seepage | Marco Island, FL | O and N Isotope | No | NA | 8 | 46438 | 152 | None |
| 180 | 20-3100 SP 10 | 50 | Filtered Seepage | Marco Island, FL | O and N Isotope | No | NA | 8 | 45898 | 415 | None |
| 181 | 20-3736 SP 10 | 50 | Filtered Seepage | Marco Island, FL | O and N Isotope | No | NA | 8 | 46200 | 398 | None |
| 182 | 20-2069 SP 11 | 50 | Filtered Seepage | Marco Island, FL | O and N Isotope | No | NA | 8 | 52211 | 180 | None |
| 183 | 20-2407 SP 11 | 50 | Filtered Seepage | Marco Island, FL | O and N Isotope | No | NA | 8 | 47740 | 76 | None |
| 184 | 20-2824 SP 11 | 50 | Filtered Seepage | Marco Island, FL | O and N Isotope | No | NA | 8 | 47508 | 179 | None |
| 185 | 20-3101 SP 11 | 50 | Filtered Seepage | Marco Island, FL | O and N Isotope | No | NA | 8 | 40068 | 166 | None |

Sample List

| | | | | | | | | | | | |
|-----|---------------------|----|---------------------|------------------|-----------------|----|----|---|-------|------|------|
| 186 | 20-3738 SP 11 | 50 | Filtered Seepage | Marco Island, FL | O and N Isotope | No | NA | 8 | 47800 | 247 | None |
| 187 | 20-2070 SP 12 | 50 | Filtered Seepage | Marco Island, FL | O and N Isotope | No | NA | 8 | 47415 | 295 | None |
| 188 | 20-2408 SP 12 | 50 | Filtered Seepage | Marco Island, FL | O and N Isotope | No | NA | 8 | 47080 | 42 | None |
| 189 | 20-2825 SP 12 | 50 | Filtered Seepage | Marco Island, FL | O and N Isotope | No | NA | 8 | 46973 | 327 | None |
| 190 | 20-3102 SP 12 | 50 | Filtered Seepage | Marco Island, FL | O and N Isotope | No | NA | 8 | 33708 | 467 | None |
| 191 | 20-3739 SP 12 | 50 | Filtered Seepage | Marco Island, FL | O and N Isotope | No | NA | 8 | 46900 | 140 | None |
| 192 | 20-2071 SP 13 | 50 | Filtered Seepage | Marco Island, FL | O and N Isotope | No | NA | 8 | 48614 | 466 | None |
| 193 | 20-2826 SP 13 | 50 | Filtered Seepage | Marco Island, FL | O and N Isotope | No | NA | 8 | 44833 | 19 | None |
| 194 | 20-3103 SP 13 | 50 | Filtered Seepage | Marco Island, FL | O and N Isotope | No | NA | 8 | 35722 | 142 | None |
| 195 | 20-3740 SP 13 | 50 | Filtered Seepage | Marco Island, FL | O and N Isotope | No | NA | 8 | 46100 | 276 | None |
| 196 | 20-2072 SP 14 | 50 | Filtered Seepage | Marco Island, FL | O and N Isotope | No | NA | 8 | 52647 | 355 | None |
| 197 | 20-2409 SP 14 | 50 | Filtered Seepage | Marco Island, FL | O and N Isotope | No | NA | 8 | 48510 | 170 | None |
| 198 | 20-2827 SP 14 | 50 | Filtered Seepage | Marco Island, FL | O and N Isotope | No | NA | 7 | 49113 | 847 | None |
| 199 | 20-3104 SP 14 | 50 | Filtered Seepage | Marco Island, FL | O and N Isotope | No | NA | 8 | 44202 | 470 | None |
| 200 | 20-3741 SP 14 | 50 | Filtered Seepage | Marco Island, FL | O and N Isotope | No | NA | 7 | 48300 | 667 | None |
| 201 | 20-2073 SP 15 | 50 | Filtered Seepage | Marco Island, FL | O and N Isotope | No | NA | 8 | 52102 | 173 | None |
| 202 | 20-2410 SP 15 | 50 | Filtered Seepage | Marco Island, FL | O and N Isotope | No | NA | 8 | 47960 | 229 | None |
| 203 | 20-2828 SP 15 | 50 | Filtered Seepage | Marco Island, FL | O and N Isotope | No | NA | 8 | 46866 | 379 | None |
| 204 | 20-3106 SP 15 | 50 | Filtered Seepage | Marco Island, FL | O and N Isotope | No | NA | 8 | 43990 | 299 | None |
| 205 | 20-3742 SP 15 | 50 | Filtered Seepage | Marco Island, FL | O and N Isotope | No | NA | 8 | 45900 | 268 | None |
| 208 | 20-3584 MI 02 | 50 | Filtered Stormwater | Marco Island, FL | O and N Isotope | No | NA | 6 | 43800 | 37 | None |
| 209 | 20-3585 MI 03 | 50 | Filtered Stormwater | Marco Island, FL | O and N Isotope | No | NA | 7 | 806 | 114 | None |
| 210 | 20-1553 MI 04 | 50 | Filtered Stormwater | Marco Island, FL | O and N Isotope | No | NA | 8 | 1593 | 4867 | None |
| 211 | 20-3586 MI 04 | 50 | Filtered Stormwater | Marco Island, FL | O and N Isotope | No | NA | 8 | 5727 | 1417 | None |
| 212 | 20-3587 MI 05 | 50 | Filtered Stormwater | Marco Island, FL | O and N Isotope | No | NA | 8 | 17602 | 265 | None |
| 213 | 20-3242 Bulk Precip | 50 | Filtered Rainwater | Marco Island, FL | O and N Isotope | No | NA | 6 | 55 | 142 | None |
| 214 | 20-3588 Bulk Precip | 50 | Filtered Rainwater | Marco Island, FL | O and N Isotope | No | NA | 6 | 17 | 194 | None |

H-2: Sample Results

Samples

Results of Stable Isotope Analyses on Marco Island Samples Collected from April - September 2020

| Analysis # | Internal ID | Sample ID | $\delta^{15}\text{N}_{\text{Air}}$ (‰) | $\delta^{18}\text{O}_{\text{VSMOW}}$ (‰) | Comments |
|------------|-------------------------|---------------------|--|--|----------|
| M-82644 | Harper 12/15/20-1 | 20-1700 Bulk Precip | -0.57 | 61.58 | |
| M-82645 | Harper 12/15/20-1 rep | 20-1700 Bulk Precip | -0.61 | 61.36 | |
| M-82646 | Harper 12/15/20-2 | 20-1753 Bulk Precip | -2.55 | 64.46 | |
| M-82647 | Harper 12/15/20-3 | 20-1871 Bulk Precip | -3.42 | 61.40 | |
| M-82648 | Harper 12/15/20-4 | 20-2016 Bulk Precip | -2.39 | 64.87 | |
| M-82650 | Harper 12/15/20-5 | 20-2178 Bulk Precip | -0.66 | 67.15 | |
| M-82651 | Harper 12/15/20-6 | 20-2310 Bulk Precip | -0.90 | 66.26 | |
| M-82652 | Harper 12/15/20-7 | 20-2340 Bulk Precip | 0.14 | 62.86 | |
| M-82653 | Harper 12/15/20-8 | 20-2394 Bulk Precip | 0.14 | 63.89 | |
| M-82654 | Harper 12/15/20-9 | 20-2497 Bulk Precip | -1.61 | 61.97 | |
| M-82659 | Harper 12/15/20-10 | 20-2557 Bulk Precip | 0.98 | 64.55 | |
| M-82660 | Harper 12/15/20-11 | 20-2636 Bulk Precip | 1.18 | 67.66 | |
| M-82661 | Harper 12/15/20-11 rep | 20-2636 Bulk Precip | 1.06 | 67.31 | |
| M-82662 | Harper 12/15/20-12 | 20-2709 Bulk Precip | -0.14 | 62.40 | |
| M-82663 | Harper 12/15/20-13 | 20-2808 Bulk Precip | -1.29 | 55.90 | |
| M-82665 | Harper 12/15/20-14 | 20-2917 Bulk Precip | 0.27 | 63.52 | |
| M-82666 | Harper 12/15/20-15 | 20-2940 Bulk Precip | 0.79 | 62.84 | |
| M-83072 | Harper 12/15/20-213 | 20-3242 Bulk Precip | -1.59 | 60.30 | |
| M-83073 | Harper 12/15/20-213 rep | 20-3242 Bulk Precip | -1.55 | 61.09 | |
| M-82667 | Harper 12/15/20-16 | 20-3451 Bulk Precip | -1.61 | 60.29 | |
| M-82668 | Harper 12/15/20-17 | 20-3554 Bulk Precip | -0.31 | 59.87 | |
| M-83074 | Harper 12/15/20-214 | 20-3588 Bulk Precip | -4.02 | 60.15 | |
| M-82669 | Harper 12/15/20-18 | 20-3727 Bulk Precip | -1.14 | 63.28 | |

| | | |
|----------------|-------|-------|
| Minimum Value: | -4.02 | 55.90 |
| Maximum Value: | 1.18 | 67.66 |
| Average Value: | -0.86 | 62.82 |

| | | | | | |
|---------|------------------------|---------------|-------|-------|--|
| M-82682 | Harper 12/15/20-20 | 20-1551 MI 01 | 0.42 | 12.92 | |
| M-83708 | Harper 12/15/20-21 | 20-1638 MI 01 | 2.87 | 6.63 | |
| M-83710 | Harper 12/15/20-21 rep | 20-1638 MI 01 | 3.03 | 7.02 | |
| M-82685 | Harper 12/15/20-22 | 20-1696 MI 01 | 2.27 | 16.98 | |
| M-82688 | Harper 12/15/20-23 | 20-2335 MI 01 | 4.69 | 6.07 | |
| M-82689 | Harper 12/15/20-24 | 20-2389 MI 01 | 3.50 | 1.92 | |
| M-82690 | Harper 12/15/20-25 | 20-2492 MI 01 | 3.06 | 1.44 | |
| M-82691 | Harper 12/15/20-26 | 20-2554 MI 01 | -1.06 | 1.70 | |
| M-82681 | Harper 12/15/20-19 | 20-2631 MI 01 | 3.09 | 37.50 | |
| M-82692 | Harper 12/15/20-27 | 20-2935 MI 01 | 13.24 | 10.01 | |
| M-82693 | Harper 12/15/20-28 | 20-3078 MI 01 | 2.57 | 1.69 | |
| M-82698 | Harper 12/15/20-29 | 20-3169 MI 01 | 4.44 | 2.29 | |
| M-82699 | Harper 12/15/20-30 | 20-3239 MI 01 | -3.82 | 4.08 | |
| M-83711 | Harper 12/15/20-31 | 20-3323 MI 01 | -0.05 | 3.94 | |
| M-83712 | Harper 12/15/20-31 rep | 20-3323 MI 01 | 0.24 | 2.33 | |
| M-84534 | Harper 12/15/20-31 rep | 20-3323 MI 01 | 0.10 | 2.81 | |
| M-84535 | Harper 12/15/20-31 rep | 20-3323 MI 01 | 0.09 | 3.08 | |
| M-82702 | Harper 12/15/20-32 | 20-3552 MI 01 | 3.94 | 3.35 | |

| | | |
|----------------|-------|-------|
| Minimum Value: | -3.82 | 1.44 |
| Maximum Value: | 13.24 | 37.50 |
| Average Value: | 2.37 | 6.99 |

Samples

Results of Stable Isotope Analyses on Marco Island Samples Collected from April - September 2020

| Analysis # | Internal ID | Sample ID | $\delta^{15}\text{N}_{\text{Air}}$ (‰) | $\delta^{18}\text{O}_{\text{VSMOW}}$ (‰) | Comments |
|------------|------------------------|---------------|--|--|-----------|
| M-82716 | Harper 12/15/20-38 | 20-1639 MI 02 | 4.04 | 12.96 | |
| M-82704 | Harper 12/15/20-33 | 20-1697 MI 02 | 1.27 | 31.98 | |
| M-82717 | Harper 12/15/20-39 | 20-2015 MI 02 | 7.22 | 10.70 | Below LOQ |
| M-82718 | Harper 12/15/20-40 | 20-2054 MI 02 | 4.77 | 3.48 | Below LOQ |
| M-82719 | Harper 12/15/20-41 | 20-2175 MI 02 | 4.95 | 6.27 | Below LOQ |
| M-82720 | Harper 12/15/20-41 rep | 20-2175 MI 02 | 6.17 | 10.84 | Below LOQ |
| M-82705 | Harper 12/15/20-34 | 20-2306 MI 02 | -2.01 | 27.57 | |
| M-82706 | Harper 12/15/20-35 | 20-2336 MI 02 | 5.17 | 31.65 | Below LOQ |
| M-82722 | Harper 12/15/20-42 | 20-2390 MI 02 | -6.08 | -0.69 | Below LOQ |
| M-82707 | Harper 12/15/20-36 | 20-2493 MI 02 | 2.60 | 13.23 | Below LOQ |
| M-82708 | Harper 12/15/20-37 | 20-2555 MI 02 | 4.52 | 20.98 | |
| M-82723 | Harper 12/15/20-43 | 20-2632 MI 02 | 5.96 | 12.21 | |
| M-82724 | Harper 12/15/20-44 | 20-2705 MI 02 | 0.15 | 6.07 | |
| M-82725 | Harper 12/15/20-45 | 20-2914 MI 02 | 3.26 | 8.03 | Below LOQ |
| M-82726 | Harper 12/15/20-46 | 20-2936 MI 02 | 9.69 | 9.65 | |
| M-82738 | Harper 12/15/20-47 | 20-3079 MI 02 | -1.40 | 2.24 | |
| M-82739 | Harper 12/15/20-48 | 20-3324 MI 02 | 4.50 | 5.85 | |
| M-82740 | Harper 12/15/20-49 | 20-3447 MI 02 | 6.50 | 8.75 | Below LOQ |
| M-83056 | Harper 12/15/20-208 | 20-3584 MI 02 | 4.03 | 5.48 | |
| M-82741 | Harper 12/15/20-50 | 20-3725 MI 02 | 4.98 | 2.59 | |

| | | |
|----------------|-------|-------|
| Minimum Value: | -6.08 | -0.69 |
| Maximum Value: | 9.69 | 31.98 |
| Average Value: | 3.51 | 11.49 |

| | | | | | |
|---------|------------------------|---------------|-------|--------|-----------|
| M-83713 | Harper 12/15/20-51 | 20-1552 MI 03 | 6.93 | -15.79 | |
| M-83721 | Harper 12/15/20-51 rep | 20-1552 MI 03 | 6.90 | -16.18 | |
| M-82756 | Harper 12/15/20-58 | 20-1640 MI 03 | 11.19 | 10.03 | Below LOQ |
| M-82746 | Harper 12/15/20-52 | 20-1698 MI 03 | 6.46 | 7.96 | |
| M-82747 | Harper 12/15/20-53 | 20-1751 MI 03 | 2.77 | -3.27 | |
| M-82748 | Harper 12/15/20-54 | 20-1869 MI 03 | 7.30 | 19.97 | Below LOQ |
| M-82757 | Harper 12/15/20-59 | 20-2055 MI 03 | 11.30 | 5.44 | Below LOQ |
| M-82758 | Harper 12/15/20-60 | 20-2176 MI 03 | 4.14 | 15.34 | Below LOQ |
| M-82759 | Harper 12/15/20-61 | 20-2307 MI 03 | -3.76 | 2.64 | Below LOQ |
| M-82761 | Harper 12/15/20-61 rep | 20-2307 MI 03 | -3.55 | 4.69 | Below LOQ |
| M-82749 | Harper 12/15/20-55 | 20-2337 MI 03 | 0.76 | -6.25 | |
| M-82762 | Harper 12/15/20-62 | 20-2391 MI 03 | -1.29 | 6.35 | Below LOQ |
| M-82750 | Harper 12/15/20-56 | 20-2494 MI 03 | 3.42 | 52.31 | |
| M-82755 | Harper 12/15/20-57 | 20-2633 MI 03 | 1.54 | 46.86 | |
| M-82763 | Harper 12/15/20-63 | 20-2706 MI 03 | -0.59 | 9.93 | |
| M-82764 | Harper 12/15/20-64 | 20-2915 MI 03 | -1.15 | 11.18 | |
| M-82765 | Harper 12/15/20-65 | 20-2937 MI 03 | -0.63 | 0.48 | |
| M-82770 | Harper 12/15/20-66 | 20-3080 MI 03 | 0.24 | 2.93 | Below LOQ |
| M-82771 | Harper 12/15/20-67 | 20-3448 MI 03 | -3.75 | -1.33 | |
| M-83057 | Harper 12/15/20-209 | 20-3585 MI 03 | 0.45 | 4.89 | |

| | | |
|----------------|-------|--------|
| Minimum Value: | -3.76 | -16.18 |
| Maximum Value: | 11.30 | 52.31 |
| Average Value: | 2.43 | 7.91 |

Samples

Results of Stable Isotope Analyses on Marco Island Samples Collected
from April - September 2020

| Analysis # | Internal ID | Sample ID | $\delta^{15}\text{N}_{\text{Air}}$ (‰) | $\delta^{18}\text{O}_{\text{VSMOW}}$ (‰) | Comments |
|------------|------------------------|---------------|--|--|-----------|
| M-83058 | Harper 12/15/20-210 | 20-1553 MI 04 | 6.97 | 7.45 | |
| M-82781 | Harper 12/15/20-74 | 20-1641 MI 04 | 16.29 | 14.67 | Below LOQ |
| M-82772 | Harper 12/15/20-68 | 20-1699 MI 04 | 15.95 | 10.20 | |
| M-82773 | Harper 12/15/20-69 | 20-1752 MI 04 | 9.50 | 3.86 | |
| M-82774 | Harper 12/15/20-70 | 20-1870 MI 04 | 0.01 | 30.98 | |
| M-82782 | Harper 12/15/20-75 | 20-2177 MI 04 | -8.58 | -5.74 | |
| M-82777 | Harper 12/15/20-71 | 20-2308 MI 04 | -1.67 | 8.69 | |
| M-82778 | Harper 12/15/20-71 rep | 20-2308 MI 04 | -1.65 | 9.03 | |
| M-82779 | Harper 12/15/20-72 | 20-2338 MI 04 | 0.50 | 25.42 | |
| M-82489 | Harper 12/15/20-76 | 20-2392 MI 04 | -4.55 | 8.41 | |
| M-82780 | Harper 12/15/20-73 | 20-2495 MI 04 | -2.58 | 14.93 | |
| M-82490 | Harper 12/15/20-77 | 20-2634 MI 04 | -12.17 | 12.04 | |
| M-82491 | Harper 12/15/20-78 | 20-2707 MI 04 | -9.26 | 2.79 | |
| M-82492 | Harper 12/15/20-79 | 20-2938 MI 04 | 8.95 | 9.84 | |
| M-82493 | Harper 12/15/20-80 | 20-3081 MI 04 | 0.03 | -0.03 | |
| M-82495 | Harper 12/15/20-81 | 20-3170 MI 04 | 2.87 | -2.10 | |
| M-82496 | Harper 12/15/20-81 rep | 20-3170 MI 04 | 2.71 | -2.08 | |
| M-82497 | Harper 12/15/20-82 | 20-3240 MI 04 | 1.03 | 2.08 | |
| M-82498 | Harper 12/15/20-83 | 20-3325 MI 04 | 3.27 | 3.59 | |
| M-82499 | Harper 12/15/20-84 | 20-3449 MI 04 | 0.39 | 3.79 | |
| M-83070 | Harper 12/15/20-211 | 20-3586 MI 04 | 1.55 | -2.25 | |

| | | |
|----------------|--------|-------|
| Minimum Value: | -12.17 | -5.74 |
| Maximum Value: | 16.29 | 30.98 |
| Average Value: | 1.41 | 7.41 |

| | | | | | |
|---------|------------------------|---------------|-------|-------|-----------|
| M-82505 | Harper 12/15/20-86 | 20-2309 MI 05 | 7.45 | 5.88 | |
| M-82506 | Harper 12/15/20-87 | 20-2339 MI 05 | 4.11 | 4.74 | Below LOQ |
| M-82507 | Harper 12/15/20-88 | 20-2393 MI 05 | 1.32 | -7.62 | |
| M-82508 | Harper 12/15/20-89 | 20-2496 MI 05 | 2.12 | 43.57 | |
| M-82510 | Harper 12/15/20-90 | 20-2556 MI 05 | 5.49 | 15.55 | |
| M-82504 | Harper 12/15/20-85 | 20-2635 MI 05 | 2.36 | 39.61 | |
| M-82511 | Harper 12/15/20-91 | 20-2708 MI 05 | -0.32 | 28.22 | |
| M-82512 | Harper 12/15/20-91 rep | 20-2708 MI 05 | -0.38 | 29.10 | |
| M-82513 | Harper 12/15/20-92 | 20-2916 MI 05 | 0.76 | 8.81 | |
| M-82514 | Harper 12/15/20-93 | 20-2939 MI 05 | 3.30 | 14.58 | |
| M-82526 | Harper 12/15/20-94 | 20-3082 MI 05 | 10.70 | 5.38 | |
| M-82527 | Harper 12/15/20-95 | 20-3171 MI 05 | 17.89 | 8.75 | |
| M-82528 | Harper 12/15/20-96 | 20-3241 MI 05 | 17.85 | 12.00 | |
| M-82529 | Harper 12/15/20-97 | 20-3326 MI 05 | 19.15 | 9.36 | |
| M-82530 | Harper 12/15/20-98 | 20-3450 MI 05 | 9.27 | 3.87 | |
| M-82533 | Harper 12/15/20-99 | 20-3553 MI 05 | 12.01 | 5.57 | |
| M-83071 | Harper 12/15/20-212 | 20-3587 MI 05 | 9.51 | 5.23 | |
| M-82534 | Harper 12/15/20-100 | 20-3726 MI 05 | 3.36 | 1.35 | |

| | | |
|----------------|-------|-------|
| Minimum Value: | -0.38 | -7.62 |
| Maximum Value: | 19.15 | 43.57 |
| Average Value: | 7.00 | 13.00 |

Samples

Results of Stable Isotope Analyses on Marco Island Samples Collected
from April - September 2020

| Analysis # | Internal ID | Sample ID | $\delta^{15}\text{N}_{\text{Air}}$ (‰) | $\delta^{18}\text{O}_{\text{VSMOW}}$ (‰) | Comments |
|------------|-------------------------|---------------|--|--|----------|
| M-82535 | Harper 12/15/20-101 | 20-1550 Reuse | 25.70 | 13.73 | |
| M-82536 | Harper 12/15/20-101 rep | 20-1550 Reuse | 25.76 | 13.56 | |
| M-82537 | Harper 12/15/20-102 | 20-1637 Reuse | 17.14 | 7.12 | |
| M-82543 | Harper 12/15/20-103 | 20-1695 Reuse | 18.22 | 7.59 | |
| M-82544 | Harper 12/15/20-104 | 20-1750 Reuse | 23.53 | 10.39 | |
| M-82545 | Harper 12/15/20-105 | 20-1868 Reuse | 23.05 | 10.26 | |
| M-82546 | Harper 12/15/20-106 | 20-2014 Reuse | 15.76 | 5.21 | |
| M-82547 | Harper 12/15/20-107 | 20-2053 Reuse | 17.79 | 7.46 | |
| M-82549 | Harper 12/15/20-108 | 20-2174 Reuse | 16.36 | 5.14 | |
| M-82550 | Harper 12/15/20-109 | 20-2305 Reuse | 17.01 | 5.29 | |
| M-83722 | Harper 12/15/20-110 | 20-2334 Reuse | 22.27 | 9.14 | |
| M-82552 | Harper 12/15/20-111 | 20-2388 Reuse | 16.31 | 4.71 | |
| M-82553 | Harper 12/15/20-111 rep | 20-2388 Reuse | 16.14 | 4.62 | |
| M-83723 | Harper 12/15/20-112 | 20-2491 Reuse | 31.41 | 14.79 | |
| M-82562 | Harper 12/15/20-113 | 20-2553 Reuse | 29.83 | 14.18 | |
| M-82563 | Harper 12/15/20-114 | 20-2630 Reuse | 25.73 | 10.44 | |
| M-82564 | Harper 12/15/20-115 | 20-2704 Reuse | 21.85 | 7.70 | |
| M-82565 | Harper 12/15/20-116 | 20-2807 Reuse | 30.51 | 10.95 | |
| M-82567 | Harper 12/15/20-117 | 20-2913 Reuse | 31.02 | 14.30 | |
| M-82568 | Harper 12/15/20-118 | 20-2934 Reuse | 30.42 | 13.32 | |
| M-82569 | Harper 12/15/20-119 | 20-3077 Reuse | 25.40 | 14.08 | |
| M-82570 | Harper 12/15/20-120 | 20-3168 Reuse | 26.73 | 12.52 | |
| M-82571 | Harper 12/15/20-121 | 20-3238 Reuse | 21.34 | 8.97 | |
| M-82583 | Harper 12/15/20-121 rep | 20-3238 Reuse | 21.26 | 8.74 | |
| M-82584 | Harper 12/15/20-122 | 20-3322 Reuse | 24.43 | 9.76 | |
| M-82585 | Harper 12/15/20-123 | 20-3446 Reuse | 17.49 | 5.89 | |
| M-83724 | Harper 12/15/20-124 | 20-3551 Reuse | 25.66 | 12.76 | |

| | | |
|----------------|-------|-------|
| Minimum Value: | 15.76 | 4.62 |
| Maximum Value: | 31.41 | 14.79 |
| Average Value: | 22.89 | 9.73 |

| | | | | | |
|---------|-------------------------|--------------------|-------|-------|-----------|
| M-82587 | Harper 12/15/20-125 | 20-2498 Reuse Pond | 16.31 | 18.38 | Below LOQ |
| M-82590 | Harper 12/15/20-126 | 20-2637 Reuse Pond | 7.33 | 12.75 | |
| M-82591 | Harper 12/15/20-127 | 20-2558 Reuse Pond | 16.14 | 15.70 | |
| M-82592 | Harper 12/15/20-128 | 20-2710 Reuse Pond | 13.82 | 11.63 | |
| M-82593 | Harper 12/15/20-129 | 20-2809 Reuse Pond | 14.94 | 14.80 | |
| M-82876 | Harper 12/15/20-130 | 20-2918 Reuse Pond | 16.53 | 13.73 | |
| M-83726 | Harper 12/15/20-131 | 20-2941 Reuse Pond | 11.14 | 10.43 | |
| M-83727 | Harper 12/15/20-131 rep | 20-2941 Reuse Pond | 11.06 | 10.17 | |
| M-82879 | Harper 12/15/20-132 | 20-3083 Reuse Pond | 13.30 | 11.55 | |
| M-82880 | Harper 12/15/20-133 | 20-3172 Reuse Pond | 13.17 | 11.69 | |
| M-82882 | Harper 12/15/20-134 | 20-3243 Reuse Pond | 13.60 | 10.35 | |
| M-82883 | Harper 12/15/20-135 | 20-3327 Reuse Pond | 13.16 | 8.92 | |
| M-82884 | Harper 12/15/20-136 | 20-3452 Reuse Pond | 7.47 | 7.61 | |
| M-82885 | Harper 12/15/20-137 | 20-3555 Reuse Pond | 2.90 | -0.69 | |

| | | |
|----------------|-------|-------|
| Minimum Value: | 2.90 | -0.69 |
| Maximum Value: | 16.53 | 18.38 |
| Average Value: | 12.20 | 11.22 |

Samples

Results of Stable Isotope Analyses on Marco Island Samples Collected from April - September 2020

| Analysis # | Internal ID | Sample ID | $\delta^{15}\text{N}_{\text{Air}}$ (‰) | $\delta^{18}\text{O}_{\text{VSMOW}}$ (‰) | Comments |
|------------|-------------------------|--------------|--|--|----------|
| M-82886 | Harper 12/15/20-138 | 20-2396 SP 1 | 1.91 | -6.81 | |
| M-82891 | Harper 12/15/20-139 | 20-2812 SP 1 | 3.22 | 1.12 | |
| M-82892 | Harper 12/15/20-140 | 20-3091 SP 1 | -0.50 | -6.40 | |
| M-82893 | Harper 12/15/20-141 | 20-3729 SP 1 | -0.02 | 1.87 | |
| M-82894 | Harper 12/15/20-141 rep | 20-3729 SP 1 | -0.07 | 1.78 | |

| | | |
|----------------|-------|-------|
| Minimum Value: | -0.50 | -6.81 |
| Maximum Value: | 3.22 | 1.87 |
| Average Value: | 0.91 | -1.69 |

| | | | | | |
|---------|---------------------|--------------|-------|------|--|
| M-82895 | Harper 12/15/20-142 | 20-2058 SP 2 | 4.15 | 0.88 | |
| M-82897 | Harper 12/15/20-143 | 20-2397 SP 2 | 3.70 | 3.20 | |
| M-82898 | Harper 12/15/20-144 | 20-2813 SP 2 | 4.40 | 5.96 | |
| M-82899 | Harper 12/15/20-145 | 20-3092 SP 2 | -2.84 | 0.50 | |
| M-82900 | Harper 12/15/20-146 | 20-3730 SP 2 | 5.51 | 3.19 | |

| | | |
|----------------|-------|------|
| Minimum Value: | -2.84 | 0.50 |
| Maximum Value: | 5.51 | 5.96 |
| Average Value: | 2.98 | 2.75 |

| | | | | | |
|---------|-------------------------|--------------|-------|------|--|
| M-82901 | Harper 12/15/20-147 | 20-2059 SP 3 | 3.62 | 1.04 | |
| M-82914 | Harper 12/15/20-148 | 20-2398 SP 3 | 2.40 | 4.30 | |
| M-82915 | Harper 12/15/20-149 | 20-2814 SP 3 | 3.46 | 2.39 | |
| M-82916 | Harper 12/15/20-150 | 20-3093 SP 3 | -1.34 | 6.54 | |
| M-82917 | Harper 12/15/20-151 | 20-3731 SP 3 | -0.45 | 5.07 | |
| M-82918 | Harper 12/15/20-151 rep | 20-3731 SP 3 | -0.60 | 4.57 | |

| | | |
|----------------|-------|------|
| Minimum Value: | -1.34 | 1.04 |
| Maximum Value: | 3.62 | 6.54 |
| Average Value: | 1.18 | 3.98 |

| | | | | | |
|---------|---------------------|--------------|-------|-------|--|
| M-82921 | Harper 12/15/20-152 | 20-2060 SP 4 | -2.79 | 0.59 | |
| M-82922 | Harper 12/15/20-153 | 20-2400 SP 4 | -4.12 | -2.00 | |
| M-82923 | Harper 12/15/20-154 | 20-2815 SP 4 | -9.87 | 0.18 | |
| M-82924 | Harper 12/15/20-155 | 20-3094 SP 4 | -8.81 | 3.17 | |
| M-82925 | Harper 12/15/20-156 | 20-3732 SP 4 | 3.92 | 1.53 | |

| | | |
|----------------|-------|-------|
| Minimum Value: | -9.87 | -2.00 |
| Maximum Value: | 3.92 | 3.17 |
| Average Value: | -4.34 | 0.70 |

| | | | | | |
|---------|---------------------|--------------|-------|-------|--|
| M-82930 | Harper 12/15/20-157 | 20-2062 SP 5 | 4.83 | -0.37 | |
| M-82931 | Harper 12/15/20-158 | 20-2817 SP 5 | -6.50 | -2.79 | |
| M-82932 | Harper 12/15/20-159 | 20-3095 SP 5 | -4.97 | -3.90 | |
| M-82933 | Harper 12/15/20-160 | 20-3733 SP 5 | -6.74 | 6.41 | |

| | | |
|----------------|-------|-------|
| Minimum Value: | -6.74 | -3.90 |
| Maximum Value: | 4.83 | 6.41 |
| Average Value: | -3.35 | -0.16 |

Samples

Results of Stable Isotope Analyses on Marco Island Samples Collected from April - September 2020

| Analysis # | Internal ID | Sample ID | $\delta^{15}\text{N}_{\text{Air}}$ (‰) | $\delta^{18}\text{O}_{\text{VSMOW}}$ (‰) | Comments |
|------------|-------------------------|--------------|--|--|----------|
| M-83728 | Harper 12/15/20-161 | 20-2063 SP 6 | 3.18 | 6.76 | |
| M-83729 | Harper 12/15/20-161 rep | 20-2063 SP 6 | 3.08 | 6.07 | |
| M-82937 | Harper 12/15/20-162 | 20-2401 SP 6 | -25.66 | -2.46 | |
| M-82938 | Harper 12/15/20-163 | 20-2818 SP 6 | 3.25 | 2.75 | |
| M-82939 | Harper 12/15/20-164 | 20-3096 SP 6 | 3.38 | 4.57 | |

| | | |
|----------------|--------|-------|
| Minimum Value: | -25.66 | -2.46 |
| Maximum Value: | 3.38 | 6.76 |
| Average Value: | -2.55 | 3.54 |

| | | | | | |
|---------|---------------------|--------------|-------|-------|--|
| M-82940 | Harper 12/15/20-165 | 20-2064 SP 7 | 3.95 | 2.27 | |
| M-82948 | Harper 12/15/20-166 | 20-2402 SP 7 | 6.09 | 0.98 | |
| M-82949 | Harper 12/15/20-167 | 20-2820 SP 7 | -6.51 | -1.55 | |

| | | |
|----------------|-------|-------|
| Minimum Value: | -6.51 | -1.55 |
| Maximum Value: | 6.09 | 2.27 |
| Average Value: | 1.17 | 0.57 |

| | | | | | |
|---------|-------------------------|--------------|-------|------|-----------|
| M-82951 | Harper 12/15/20-169 | 20-2404 SP 8 | 5.61 | 2.73 | |
| M-82952 | Harper 12/15/20-170 | 20-2821 SP 8 | 1.58 | 5.70 | |
| M-82954 | Harper 12/15/20-171 | 20-3097 SP 8 | -0.56 | 0.86 | Below LOQ |
| M-82955 | Harper 12/15/20-171 rep | 20-3097 SP 8 | -0.83 | 7.93 | Below LOQ |
| M-82956 | Harper 12/15/20-172 | 20-3734 SP 8 | -5.97 | 4.91 | |

| | | |
|----------------|-------|------|
| Minimum Value: | -5.97 | 0.86 |
| Maximum Value: | 5.61 | 7.93 |
| Average Value: | -0.03 | 4.43 |

| | | | | | |
|---------|---------------------|--------------|-------|-------|--|
| M-82957 | Harper 12/15/20-173 | 20-2066 SP 9 | -1.91 | -8.65 | |
| M-82958 | Harper 12/15/20-174 | 20-2405 SP 9 | 1.27 | -2.24 | |
| M-82971 | Harper 12/15/20-175 | 20-2822 SP 9 | 2.91 | 0.35 | |
| M-82972 | Harper 12/15/20-176 | 20-3099 SP 9 | 3.23 | 3.22 | |

| | | |
|----------------|-------|-------|
| Minimum Value: | -1.91 | -8.65 |
| Maximum Value: | 3.23 | 3.22 |
| Average Value: | 1.38 | -1.83 |

| | | | | | |
|---------|-------------------------|---------------|--------|--------|--|
| M-82973 | Harper 12/15/20-177 | 20-2068 SP 10 | 3.48 | -12.55 | |
| M-82974 | Harper 12/15/20-178 | 20-2406 SP 10 | -3.36 | -7.91 | |
| M-82975 | Harper 12/15/20-179 | 20-2823 SP 10 | 1.10 | 1.72 | |
| M-82978 | Harper 12/15/20-180 | 20-3100 SP 10 | -19.63 | -3.23 | |
| M-82979 | Harper 12/15/20-181 | 20-3736 SP 10 | -4.40 | 1.96 | |
| M-82980 | Harper 12/15/20-181 rep | 20-3736 SP 10 | -4.40 | 1.01 | |

| | | |
|----------------|--------|--------|
| Minimum Value: | -19.63 | -12.55 |
| Maximum Value: | 3.48 | 1.96 |
| Average Value: | -4.53 | -3.17 |

Samples

Results of Stable Isotope Analyses on Marco Island Samples Collected from April - September 2020

| Analysis # | Internal ID | Sample ID | $\delta^{15}\text{N}_{\text{Air}}$ (‰) | $\delta^{18}\text{O}_{\text{VSMOW}}$ (‰) | Comments |
|------------|---------------------|---------------|--|--|----------|
| M-82981 | Harper 12/15/20-182 | 20-2069 SP 11 | 5.43 | 3.00 | |
| M-82982 | Harper 12/15/20-183 | 20-2407 SP 11 | 2.23 | 8.50 | |
| M-82987 | Harper 12/15/20-184 | 20-2824 SP 11 | 2.67 | 3.37 | |
| M-82988 | Harper 12/15/20-185 | 20-3101 SP 11 | -5.34 | -7.32 | |
| M-82989 | Harper 12/15/20-186 | 20-3738 SP 11 | 1.57 | 1.94 | |

| | | |
|----------------|-------|-------|
| Minimum Value: | -5.34 | -7.32 |
| Maximum Value: | 5.43 | 8.50 |
| Average Value: | 1.31 | 1.90 |

| | | | | | |
|---------|-------------------------|---------------|-------|--------|--|
| M-82990 | Harper 12/15/20-187 | 20-2070 SP 12 | 9.77 | 1.96 | |
| M-82991 | Harper 12/15/20-188 | 20-2408 SP 12 | 5.78 | 2.58 | |
| M-82993 | Harper 12/15/20-189 | 20-2825 SP 12 | 3.61 | 0.37 | |
| M-82994 | Harper 12/15/20-190 | 20-3102 SP 12 | -1.15 | -11.84 | |
| M-83032 | Harper 12/15/20-191 | 20-3739 SP 12 | 2.76 | 1.41 | |
| M-83033 | Harper 12/15/20-191 rep | 20-3739 SP 12 | 2.79 | 1.51 | |

| | | |
|----------------|-------|--------|
| Minimum Value: | -1.15 | -11.84 |
| Maximum Value: | 9.77 | 2.58 |
| Average Value: | 3.93 | -0.67 |

| | | | | | |
|---------|---------------------|---------------|--------|-------|-----------|
| M-83034 | Harper 12/15/20-192 | 20-2071 SP 13 | -4.05 | -5.26 | Below LOQ |
| M-83035 | Harper 12/15/20-193 | 20-2826 SP 13 | -3.81 | 4.74 | |
| M-83036 | Harper 12/15/20-194 | 20-3103 SP 13 | -10.26 | -0.05 | |
| M-83039 | Harper 12/15/20-195 | 20-3740 SP 13 | -2.13 | 0.47 | |

| | | |
|----------------|--------|-------|
| Minimum Value: | -10.26 | -5.26 |
| Maximum Value: | -2.13 | 4.74 |
| Average Value: | -5.06 | -0.03 |

| | | | | | |
|---------|---------------------|---------------|-------|-------|--|
| M-83040 | Harper 12/15/20-196 | 20-2072 SP 14 | 1.35 | -4.09 | |
| M-83041 | Harper 12/15/20-197 | 20-2409 SP 14 | -7.78 | -2.27 | |
| M-83042 | Harper 12/15/20-198 | 20-2827 SP 14 | 1.63 | 1.77 | |
| M-83043 | Harper 12/15/20-199 | 20-3104 SP 14 | -3.07 | -7.50 | |
| M-83048 | Harper 12/15/20-200 | 20-3741 SP 14 | -6.17 | -2.02 | |

| | | |
|----------------|-------|-------|
| Minimum Value: | -7.78 | -7.50 |
| Maximum Value: | 1.63 | 1.77 |
| Average Value: | -2.81 | -2.82 |

| | | | | | |
|---------|-------------------------|---------------|-------|-------|--|
| M-83049 | Harper 12/15/20-201 | 20-2073 SP 15 | -1.19 | 0.19 | |
| M-83050 | Harper 12/15/20-201 rep | 20-2073 SP 15 | -1.17 | -0.34 | |
| M-83051 | Harper 12/15/20-202 | 20-2410 SP 15 | 1.46 | -1.75 | |
| M-83052 | Harper 12/15/20-203 | 20-2828 SP 15 | 1.32 | 1.29 | |
| M-83054 | Harper 12/15/20-204 | 20-3106 SP 15 | -2.38 | -5.47 | |
| M-83055 | Harper 12/15/20-205 | 20-3742 SP 15 | 0.29 | 2.26 | |

| | | |
|----------------|-------|-------|
| Minimum Value: | -2.38 | -5.47 |
| Maximum Value: | 1.46 | 2.26 |
| Average Value: | -0.28 | -0.64 |

APPENDIX I

**MARCO ISLAND
FERTILIZER ORDINANCE**

ORDINANCE 16-02

AN ORDINANCE OF THE CITY OF MARCO ISLAND, FLORIDA AMENDING CHAPTER 18, ENTITLED "ENVIRONMENT", ESTABLISHING ARTICLE III, ENTITLED "FERTILIZER REGULATIONS", SECTIONS 18-61 THROUGH 18-100, INCLUSIVE; AMENDING ARTICLE IV, ENTITLED "MARCO ISLAND LAWN AND LANDSCAPING MAINTENANCE CERTIFICATION REGULATIONS" IN CHAPTER 8, ENTITLED "BUSINESSES", IN THE MARCO ISLAND CODE OF ORDINANCES; REVISING THE REGISTRATION AND PERMITTING REQUIREMENTS FOR LAWN AND LANDSCAPING BUSINESSES; PROVIDING FOR CONFLICTS; PROVIDING FOR SEVERABILITY; PROVIDING FOR INCLUSION IN THE CODE; AND PROVIDING FOR AN EFFECTIVE DATE.

WHEREAS, pursuant to Article VIII, Section 2 of the Florida Constitution, and Chapter 166, Florida Statutes, the City of Marco Island is authorized to protect the public health, safety and welfare of its residents and has the power and authority to enact regulations for valid governmental purposes that are not inconsistent with general or special law; and

WHEREAS, Section 1.01 of the Marco Island Charter empowers the City to adopt, amend, or appeal ordinances, resolutions and codes as may be required for the benefit of the City; and

WHEREAS, the Marco Island City Council desires to regulate the use of fertilizers containing nitrogen or phosphorous to minimize the negative environmental effects these fertilizers have in and on the waterbodies within and around the City of Marco Island, which degrade the quality of life, and jeopardize the health, safety, and welfare of the citizens of Marco Island; and

WHEREAS, Marco Island City Council finds it to be in the best interests of its citizens to amend the Marco Island Code of Ordinances accordingly.

NOW, THEREFORE, BE IT ORDAINED BY THE CITY COUNCIL OF THE CITY OF MARCO ISLAND, FLORIDA¹ :

SECTION 1. Recitals.

The foregoing "WHEREAS" clauses are hereby ratified and confirmed as being true, correct and reflective of the legislative intent underlying this Ordinance.

SECTION 2. Amendment Adding Fertilizer Regulations.

The Code of Ordinances, Marco Island, Florida, is hereby revised by establishing Article III, entitled "Fertilizers Regulations", Sections 18-61 through 18-100, inclusive, in Chapter 18, entitled "Environment", as follows:

Chapter 18 -- ENVIRONMENT

....

ARTICLE III. – FERTILIZER REGULATIONS

Sec. 18-61. - Short title.

This Article shall be known and may be cited as the "City of Marco Island Fertilizer Control Ordinance".

Sec. 18-62. - Intent and Purpose.

- (1) To provide for the regulation of fertilizers containing nitrogen or phosphorous and to provide specific management guidelines for fertilizer application in order to minimize the negative environmental effects said fertilizers have in and on the waterbodies within and surrounding the City of Marco Island.
- (2) These guidelines and practices are established to help communities, developers, builders, contractors, businesses and homeowners be partners in improving and protecting Florida's environment.
- (3) This Article III "Fertilizer Regulations" is based on the *Model Ordinance for Florida-Friendly Fertilizer Use* or equivalent as encouraged by Section 403.9337, Florida Statutes.

¹ Proposed additions to existing City Code text are shown by underlining; proposed deletions from existing City Code text are shown by ~~strike through~~.

- (4) Nitrogen and phosphorous are essential ingredients for plant growth; however, overuse and improper application of these nutrients create water quality issues and pollute our treasured natural waters. They promote algae blooms and other excessive plant growth. Low to no phosphorus fertilizer and slow release nitrogen fertilizer, along with proper utilization, result in absorption by plants and lower levels of nitrogen and phosphorus reaching the water bodies within and surrounding the City of Marco Island and their associated watersheds.
- (5) Certification and training, as required by Article IV (Marco Island Lawn and Landscape Maintenance Registration Regulations), will result in increasing the knowledge of lawn and landscape maintenance professionals, and their customers, of:
- (a). The effects of pesticides, fertilizers and overwatering on the environment;
 - (b). Ways to reduce the amount of fertilizers and pesticides utilized; and
 - (c). Methods to limit water use on lawns and landscapes thus potentially lowering the impacts of nonpoint source pollution on local water bodies.

Sec. 18-63. - Definitions.

Application means the physical deposition of fertilizer to turf or landscape plants.

Applicator means any person who applies, in any manner, fertilizer to turf or landscape plants within the city as defined in this ordinance.

Approved Best Management Practices Training Program means a training program approved per Section 403.9338, Florida Statutes, or any more stringent requirements set forth in this Article that includes the most current version of the Florida Department of Environmental Protection's "Florida-friendly Best Management Practices for Protection of Water Resources by the Green Industries, 2008," as revised, and approved by the City Manager or designee.

Best Management Practices means turf and landscape practices or combination of practices based on research, field-testing, and expert review, determined to be the most effective and practicable means, including economic and technological considerations, for improving water quality, conserving water supplies and protecting natural resources.

City Manager means the City Manager or his designee, who will administer and enforce the provisions of this Article.

Code Compliance Officer or Inspector means any designated employee or agent of the City of Marco Island whose duty it is to enforce codes and ordinances enacted by the City.

Commercial Fertilizer Applicator, except as provided in Section 482.1562(9), Florida Statutes, means any person who applies fertilizer for payment or other consideration to property not owned by the person or firm applying the fertilizer and includes the employer of the applicator.

¹ Proposed additions to existing City Code text are shown by underlining; proposed deletions from existing City Code text are shown by ~~strikethrough~~.

Fertilize, fertilizing, or fertilization means the act of applying fertilizer to a lawn (turf), specialized turf, or landscape plant.

Fertilizer means any substance that contains nitrogen, phosphorus, or any combination of these plant nutrients and promotes plant growth, or controls soil acidity or alkalinity, or provides other soil enrichment, or provides other corrective measures to the soil.

Guaranteed Analysis means the percentage of plant nutrients or measures of neutralizing capability claimed to be present in a fertilizer.

Impervious surface means a constructed surface, such as a sidewalk, road, parking lot, or driveway, covered by impenetrable materials such as asphalt, concrete, brick, pavers, stone, or highly compacted soils.

Institutional Applicator means any person, other than a private, non-commercial or commercial applicator who applies fertilizer for the purpose of maintaining turf or landscape plants. Institutional applicators shall include, but shall not be limited to, owners and managers or employees of public lands, schools, parks, religious institutions, utilities, industrial or business sites, and any residential properties maintained in condominium or common ownership.

Landscape Plant means any native or exotic tree, shrub, or groundcover (excluding turf).

Lawn and Landscape Professional means any person who engages in solicitation for the delivery of lawn or landscaping maintenance and services.

Low Maintenance Zone means an area a minimum of ten (10) feet wide adjacent to watercourses which is planted and managed in order to minimize the need for fertilization, watering, mowing, etc.

Leaching means the process by which soluble constituents are dissolved and filtered through the soil by a percolating fluid.

Non-Commercial Applicator means any person other than a commercial fertilizer applicator or institutional applicator who applies fertilizer on turf or landscape plants in the city, such as an individual owner of a single-family residential unit.

Person means any natural person and shall also mean any business, corporation, association, club, organization, and/or any group of people acting as an organized entity.

Prohibited Application Period means the time period during which any of the following are likely: Flood Watch or Warning, or a Tropical Storm Watch or Warning, or a Hurricane Watch or Warning is in effect for any portion of Collier County, issued by the National Weather

¹ Proposed additions to existing City Code text are shown by underlining; proposed deletions from existing City Code text are shown by ~~strikethrough~~.

Service, or if heavy rain (World Meteorological Organization definition of heavy rain is rainfall greater than or equal to 50 mm (2 inches) in a 24 hour period).

Rainy season means June 1 through September 30 of each calendar year.

Rapid Release or Water Soluble Nitrogen means any product containing:

- (1) Ammonium Nitrate.
- (2) Ammonium Sulfate.
- (3) Calcium Nitrate.
- (4) Diammonium Phosphate.
- (5) Monoammonium Phosphate.
- (6) Potassium Nitrate.
- (7) Sodium Nitrate.
- (8) Urea (not in the form of slow release nitrogen).
- (9) Others as may be designated in writing by the Administrator.

Runoff means the water that results from and occurs following a rain event, or following an irrigation event, because the water is not absorbed by the soil or landscape and flows from the area.

Saturated Soil means a soil in which the voids are filled with water. Saturation does not require flow. For the purposes of this ordinance, soils shall be considered saturated if standing water is present or the pressure of a person standing on the soil causes the release of free water.

Slow Release, Controlled Release, Timed Release, Slowly Available, or Water Insoluble Nitrogen means nitrogen in a form which delays its availability for plant uptake and use after application, or which extends its availability to the plant longer than a “rapid release nitrogen” product. Forms of slow release, controlled release, slowly available, or water insoluble nitrogen include:

- (1) Isobutylidene diurea (IBUD).
- (2) Resin, Polymer, or Sulphur coated urea.
- (3) Biosolids or residuals from domestic wastewater treatment.
- (4) Ureaformaldehyde.
- (5) Composted animal manure.
- (6) Others as may be designated in writing by the City Manager or designee.

Turf, Sod, or Lawn means a piece of grass-covered soil held together by the roots of the grass.

Wetlands means those areas that are inundated or saturated by surface water or ground water at a frequency and a duration sufficient to support, and under normal conditions do support, a prevalence of vegetation typically adapted for life in saturated soils [See 62-340 F.A.C.].

Yard Waste means shredded yard clippings, leaves, grass clippings, coconuts, limbs and any plant debris created in the act of mowing, trimming and removal of vegetation.

Sec. 18-64. - Fertilizer Regulations.

(1) Applicability. This Section shall be applicable to and shall regulate any and all applicators of fertilizer and areas of application of fertilizer within the City of Marco Island unless such applicator is specifically exempted by the terms of this Section from the regulatory provisions of this Section. This Section shall be prospective only, and shall not impair any existing contracts.

(2) Exemptions. This Section shall not apply to:

(a) Bona fide farm operations as defined in the Florida Right to Farm Act, Section 823.14, Florida Statutes.

(b) Other properties not subject to or covered under the Florida Right to Farm Act that have pastures used for grazing livestock.

(c) Yard waste compost, mulches, or other similar materials that are primarily organic in nature and are applied to improve the physical condition of the soil. Yard wastes shall not be disposed of or stored by shorelines, seawalls, swales or near storm drains.

(d) Athletic Fields that are maintained by a public entity and used by the public are exempt from fertilizer application regulations under Section 18-64 (6)a of this Article.

(e) Newly planted turf and/or landscape plants may be fertilized only for a sixty (60) day period beginning 30 days after planting, if needed to allow the plants to become well established. Caution should be used to prevent direct deposition of nitrogen and phosphorus into the water.

(3) Impervious surfaces. Fertilizer shall not be applied, spilled, or otherwise deposited on any impervious surfaces. Any fertilizer applied, spilled, or deposited, either intentionally or accidentally, on any impervious surface shall be immediately and completely removed. Fertilizer released on an impervious surface must be immediately contained and either legally applied to turf or any other legal site, or returned to the original or other appropriate container. In no case shall grass clippings, vegetative material, and/or vegetative debris, including coconuts either intentionally or accidentally, be washed, swept, thrown, or blown off into stormwater drains, ditches, conveyances, water bodies, wetlands, sidewalks or roadways.

(4) Fertilizer Free Zones.

(a) Fertilizer shall not be applied within ten (10) feet of any pond, stream, storm drain, watercourse, lake, canal or wetland as defined by the Florida Department of Environmental Protection, or from the top of a seawall.

(b) Spreader deflector shields are required when fertilizing adjacent to Fertilizer Free Zones or impervious surfaces.

(5) Timing of Fertilizer Application.

(a) No applicator shall apply fertilizers containing nitrogen or phosphorous to turf and/or landscape plants during the rainy season (June 1 - September 30) and the Prohibited Application Period and to saturated soils.

(6) Fertilizer Content and Application Rate.

(a) Phosphorus fertilizer shall not be applied to turf or landscape plants unless a soil or tissue deficiency has been verified by an approved test. Where a deficiency has been verified, phosphorous fertilizer shall not be applied at application rates that exceed 0.25 lbs. P₂O₅/1000 ft² per application and not to exceed 0.50 lbs. P₂O₅/1000 ft² per year.

(b) Fertilizer applied to turf or landscape plants within the city must contain no less than 50% slow release nitrogen per guaranteed analysis label as guaranteed analysis and label are defined in chapter 576, Florida Statutes.

(c) Total Yearly Applications. Fertilizers shall not be applied more than four (4) times during any one calendar year to a single area. No more than four (4) pounds of nitrogen per 1000 square feet shall be applied to any turf or landscape area in any calendar year.

(d) Where fertilizer application is not described in this article, fertilizer shall be applied in accordance with requirements and directions provided by Rule 5E-1.003, Florida Administrative Code for turf and as found in UF/IFAS recommendations for landscape plants, vegetable gardens, and fruit trees and shrubs.

7) Education and Outreach.

(a) The City of Marco Island will provide educational materials, notices and/or presentations notifying residents that fertilizers applied within the City shall be formulated and applied in compliance with this Section.

i) The Beautification Committee, in conjunction with City staff, shall incorporate into their community outreach programs no less than two educational sessions on the requirements of the fertilizer ordinance per year.

(b) Retail businesses within the City selling fertilizer are requested to post a notice in a conspicuous location near the fertilizer notifying customers of this ordinance.

Sec. 18-65 - Permitting, Penalties and Enforcement.

1) Permitting. All persons intending to apply fertilizer are required to obtain appropriate permits from the City.

(a) A minimum of one business day prior to fertilizer application within the City, the person must apply for an e-mail permit, free of charge, indicating the location, type of fertilizer and acknowledgement that a spreader deflector will be utilized.

(b) Codes Enforcement may visit any site where fertilization is occurring and stop work if a permit was not received or if improper products or methods are being employed.

- 2) Upon the request of Code Enforcement, applicators shall be required to provide the label for fertilizer being applied to verify compliance with this ordinance.
- 3) Any person who violates any provision of this ordinance shall be guilty of a noncriminal infraction. Violators will be subject to the issuance of a citation imposing the following penalties: (i) First Violation -- a fine up to \$150; and (ii) Each Subsequent Violation -- a fine not to exceed \$300.
- 4) Any person or persons, firm or corporation, or any agent thereof, who violates any of the provisions of any Section of this Article shall be punished by revocation of any certification issued under this Article, and other penalties as may be imposed by the Code Enforcement Magistrate pursuant to this Code, Chapter 14 of City Code of Ordinances, and Florida law.

Secs. 18-66 --- 18-100. - Reserved

SECTION 3. Amendments to Marco Island Lawn and Landscaping Maintenance Certification Regulations.

The Code of Ordinances, Marco Island, Florida, is hereby revised by amending Article IV, entitled "Marco Island Lawn and Landscaping Maintenance Certification Regulations", Sections 8-71 through 8-81, inclusive, in Chapter 8, entitled "Businesses", as follows:

Chapter 8. - BUSINESSES

....

**ARTICLE IV. -- MARCO ISLAND LAWN AND LANDSCAPE MAINTENANCE
CERTIFICATION REGISTRATION REGULATIONS**

Sec. 8-70. - Intent and purpose.

The intent and purpose of this article is to require any person or business entity performing lawn or landscaping maintenance work in the City of Marco Island to possess minimum

¹ Proposed additions to existing City Code text are shown by underlining; proposed deletions from existing City Code text are shown by ~~strikethrough~~.

qualifications and competency that will assist in strengthening and promoting public awareness of the need to engage in certain lawn and landscape maintenance activities and therefore mitigate long-term and immediate adverse impacts from stormwater run-off into natural water bodies located in and adjacent to the City of Marco Island.

Sec. 8-71. - Definitions.

The following words, terms and phrases, when used in this article, shall have the meanings ascribed to them in this section, except where the context clearly indicates a different meaning:

Applicator means any person who applies, in any manner, fertilizer to turf or landscape plants within the City as defined in this ordinance.

Certification means the process of completing the State approved course and test as required in Florida Statute 482.1562

Commercial Fertilizer Applicator, except as provided in Section 482.1562(9), Florida Statutes, means any person who applies fertilizer for payment or other consideration to property not owned by the person or firm applying the fertilizer and includes the employer of the applicator.

Landscape architect means an individual licensed by the State of Florida responsible for the preparation of landscaping plans and design.

Lawn and landscape professional means any person who engages in solicitation for the delivery of lawn, landscaping or lawn or landscaping maintenance services.

Non-Commercial Applicator means any person other than a commercial fertilizer applicator or institutional applicator who applies fertilizer on turf or landscape plants in the City, such as an individual owner of a single-family residential unit.

Registration is the process of applying to the City for recognition of appropriate certification to apply fertilizer within the City and receipt of a decal identifying the vehicles of the approved applicators.

Sec. 8-72. – ~~Exemptions~~ ~~Exception~~.

The ~~certification~~ registration requirement of this article shall not apply to the following:

- (1) Any individual non-commercial property owner engaging in lawn, landscaping or lawn or landscaping maintenance on one's own property;
- (2) Any landscape architects licensed by the State of Florida engaging in lawn or landscaping maintenance services;

¹ Proposed additions to existing City Code text are shown by underlining; proposed deletions from existing City Code text are shown by ~~strikethrough~~.

- (3) Any individual or business entity, which possesses a license from the State of Florida to apply herbicides, pesticides, chemicals; or
- (4) Any individual or business entity possessing a valid specialty contractor's license from Collier County, Florida for the delivery of services such as landscaping, tree removal and trimming, and irrigation.

Sec. 8-73. - Regulated activities.

- (a) It shall be a violation of this Code to provide any lawn and landscaping, ~~or lawn or landscaping~~ maintenance and services in the city without first being certified and registered with the city as a lawn and landscape professional as provided herein.
- (b) Any lawn and landscaping ~~or lawn or landscape~~ maintenance and services, including fertilizer application, provided to the city by a lawn and landscape professional shall have at least one supervisor at each work site registered with ~~certified by~~ the city as a lawn and landscape professional. In addition, all business entities under contract with the city shall have ten percent of their staff certified and registered with ~~by~~ the city as a lawn and landscape professional within six months of entering into a contract with the city; and 50 percent of their staff certified by the city as a lawn and landscape professional within one year of entering into a contract with the city.
- (c) Any lawn and landscaping ~~and landscape~~ maintenance or services, including fertilizer application, provided by lawn and landscape professionals within the city shall have at least one supervisor ~~certified by~~ and registered with the city as a lawn and landscape professional. These businesses shall provide at least one supervisor and/or crew leader per vehicle ~~certified~~ registered by the city as a lawn and landscape professional within one year of adoption. Any landscaping professional applying fertilizer is required to be state certified and city registered.

Sec. 8-74. - Certification application; contents.

1) Training and Licensing.

- a) Section 482.1562, Florida Statutes, contains language regarding the limited certification of urban landscape commercial fertilizer application. Fertilizer applicators, as certified under that section of state statute, shall have and carry in their possession at all times when applying fertilizer, evidence of that certification.
- b) The City also hereby requires lawn and landscape professionals, except as exempted above, to abide by and successfully complete the six-hour training program in the *Florida-Friendly Best Management Practices for Protection of Water Resources by the Green Industries* offered by the Florida Department of Environmental Protection through

¹ Proposed additions to existing City Code text are shown by underlining; proposed deletions from existing City Code text are shown by ~~strikethrough~~.

the University of Florida Extension program (or approved equivalent), as well as local ordinance requirements, as amended.

2) Lawn and Landscape Professional Registration. It shall be a violation of this Article for lawn and landscape professionals, except as exempted above, to fertilize lawns or landscape plants without first being certified with the state of Florida and business registered with the City as provided herein.

a) Any lawn, landscaping and landscape maintenance business that applies fertilizer shall register supervisors/crew leaders with the City.

b) Lawn and Landscape Professionals registering with the City as such shall:

i) Attend and successfully complete the six-hour training program as described above.

ii) Attend and successfully complete the three-hour annual refresher course (or approved equivalent) for renewal of registration.

~~(1) Except as otherwise provided in section 8-72, all persons before entering into or upon property within the city to perform lawn, landscaping or lawn or landscaping maintenance shall demonstrate knowledge of the relationship between their profession and the environment through both experience and education.~~

iii) Certification and registration shall be based on demonstrated ability, experience, and education in the following areas of competency:

(a) Effects of the environment from sediment, nutrients, and pesticides moving off-site through surface or ground water.

(b) Site design and plant selection to enhance the natural environment.

(c) Rates and methods of applying fertilizer and irrigation that minimize negative environmental consequences.

(d) Utilization of integrated pest management to both minimize pests and decrease chemical applications.

iv) Illustrate an ability to apply his or her knowledge of the concepts identified herein by providing a written, detailed management plan that outlines maintenance activities to be carried out for specific locations.

v) Provide an initial application fee of \$50.00, which shall be used to defray the costs of the program. A fee of \$15.00 shall be charged to renew certification. The application fee may be amended by resolution of the City Council as may be necessary.

~~(1) A person applying for certification by the city as a lawn and landscape maintenance professional shall provide evidence of completing a course of study from the Rookery~~

~~Bay National Estuarine Research Reserve, Naples, Florida, or other approved provider, with at least six hours of instruction in the areas identified under section 2. Confirmation of attendance in a three-hour annual refresher course from Rookery Bay National Estuarine Research Reserve, or other approved provider must be provided to the city prior to issuance of a renewal certification.~~

- (2) ~~A person applying for certification by the city as a lawn and landscape maintenance professional shall illustrate an ability to apply his or her knowledge of the concepts identified herein by providing a written, detailed management plan that outlines maintenance activities to be carried out for a specific location.~~
- c) (4) The city shall provide any person who has satisfied the requirement set forth herein and paid the application fee, a certificate registration and a decal indicating the city considers that person to be a certified lawn and landscape maintenance professional.
- d) (5) The certification registration program shall be managed and administered by the growth management department. However, the ~~city council~~ City Manager or designee shall retain the authority to approve certification registration of any applicant for lawn and landscape registration maintenance certification.
- e) It shall be the responsibility of the landscape professional to complete required training and to register with the City.

Sec. 8-75. - Duration, renewal.

A certification registration issued under this article shall be valid for one year. Renewals for an additional one-year period may be granted, unless previously issued registrations certificates are revoked as provided in this article. A maximum of two one-year renewals will be granted without submission of a new registration certification application and without payment of the applicable registration certification fee. However, prior to receiving a renewed registration certification, the applicant must update and make any necessary changes needed to the previously submitted certification application. Certification with the state must occur in compliance with state regulations.

Sec. 8-76. - Duty to carry, exhibit certification and receive appropriate permit.

- (1) Identification. Every certified registered lawn and landscaping professional shall carry his or her registration certification and photo identification at all times while engaged in lawn or landscaping maintenance work in the city.

- a) The City-issued Lawn and Landscape Professionals decal shall be displayed on every state-licensed motor vehicle used by a commercial fertilizer applicator or institutional applicator, and by lawn and landscape maintenance professionals when performing services within the City limits. One decal will be issued with each registration; each additional decal will cost \$5. The decal shall be displayed prominently and in such a manner as not to be obstructed.
- (2) Permitting. All registered landscape professionals are required to obtain appropriate permits from the City.
 - a) A minimum of one business day prior to fertilizer application within the City, the registered professional must apply for an e-mail permit, free of charge, indicating the location, type of fertilizer and acknowledgement that a spreader deflector will be utilized.
 - b) Codes Enforcement may visit any site where fertilization is occurring and stop work if a permit was not received or if improper products or methods are being employed.

Sec. 8-77. - Reserved. Fees.

~~An initial application fee shall be \$25.00, which shall be used to defray the costs of certificates and other expenses of the program. A fee of \$25.00 shall be charged to renew certification. The application fee may be amended by resolution of the city council as may be necessary.~~

Sec. 8-78. - Revocation authorized; grounds.

~~Certifications~~ Registration issued under this article may be revoked by the city manager or ~~the city manager's~~ designee after notice and hearing for any of the following offenses:

- (1) Fraud, misrepresentation or a false statement in the application.
- (2) Fraud, misrepresentation or a false statement in the performance of lawn or landscaping maintenance services.
- (3) Violation of any condition, provision or qualification provided in the application.
- (4) Conviction, nolo contendere plea or forfeiture resulting from violation of any city, state or federal law involving theft, fraud, violence or moral turpitude.
- (5) Conducting business in an unlawful manner or in such manner as to threaten breach of the peace or menace to public health, safety or welfare.
- (6) Failure to comply with any provision of this article and applicable sections of Chapter 18-Environment, of the Marco Island Code of Ordinances.

Sec. 8-79. - Notice of revocation.

¹ Proposed additions to existing City Code text are shown by underlining; proposed deletions from existing City Code text are shown by ~~strikethrough~~.

- (1) Written notice of revocation of a ~~certification~~ registration issued under this article and the grounds therefor shall be mailed or delivered to a certified lawn and landscaping professional at the address specified in its application.
- (2) The public will be notified of revocation of any landscaping professional's registration through the monthly report to City Council, on the City's website and a notification will be posted at City Hall.

Sec. 8-80. - Appeal.

Any person aggrieved by the denial of a ~~certification~~ registration or revocation of a ~~certification~~ registration shall have the right of appeal to the city council. Such appeal shall be taken by filing with the city manager or designee, within 14 days after notice of the action complained of has been mailed or delivered to such person's last known address, a written statement setting forth fully the grounds for the appeal. The city manager or designee shall set a time and place for a hearing on such appeal and notice of such hearing shall be given to the appellant at least five days before the date of said hearing. The decision and order of the city council on such appeal shall be final.

Sec. 8-81. - Penalties.

Any person or persons, firm or corporation, or any agent thereof, who violates any of the provisions of any section of this article shall be punished by revocation of any ~~certification~~ registration issued under this article, and other penalties as may be imposed by the Code Enforcement ~~Magistrate board~~ pursuant to Florida Law or this Code.

SECTION 4. Codification.

It is the intention of the City Council, and it is hereby ordained that the amendments to the City of Marco Island Code of Ordinances made by this Ordinance shall constitute a new Article V to Chapter 8 of the City of Marco Island Code of Ordinances, and that the sections of this Ordinance may be renumbered and re-lettered as necessary, and that the word "Ordinance" may be changed to "Section, "Article" or other appropriate word.

¹ Proposed additions to existing City Code text are shown by underlining; proposed deletions from existing City Code text are shown by ~~strikethrough~~.

SECTION 5. Conflicts.

All ordinances or parts of ordinances and all resolutions or parts of resolutions in conflict with the provisions of this Ordinance are hereby superseded and resolved to the extent of any conflict in favor of the provisions of this Ordinance.

SECTION 6. Severability.

If any term, section, clause, sentence or phrase of this Ordinance is for any reason held to be invalid, illegal, or unconstitutional by a court of competent jurisdiction, the holding shall not affect the validity of the other or remaining terms, sections, clauses, sentences, or phrases portions of this Ordinance, and this Ordinance shall be read and/or applied as if the invalid, illegal, or unenforceable term, provision, clause, sentence, or section did not exist.

SECTION 7. Effective Date.

This Ordinance shall become effective immediately following its adoption by the City Council.

ADOPTED BY THE CITY COUNCIL OF THE CITY OF MARCO ISLAND this 7th day of March 2016.

ATTEST:

CITY OF MARCO ISLAND, FLORIDA



Laura M. Litzan, City Clerk

By: 

Robert C. Brown, Chairman

Approved as to form and legal sufficiency:

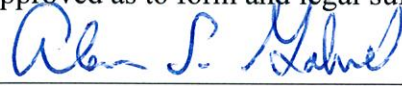

Alan L. Gabriel, City Attorney

¹ Proposed additions to existing City Code text are shown by underlining; proposed deletions from existing City Code text are shown by ~~striketrough~~.